



IBM Software

Automation Scenarios for a z/VM Cluster and Linux on System z Guests

SHARE Session 14576

Tracy Dean, IBM
tld1@us.ibm.com

March 2014



Agenda

- **Housekeeping items**
- **Introduction to recommended practices and examples**
- **Brief overview of product being used**
 - IBM Operations Manager for z/VM
 - What's new in V1.5 – available October 25, 2013
- **Recommended practices in detail**
 - Live demonstrations
 - Configuration and sample code
- **Considerations for z/VM Single System Image**
- **Summary**
 - Reference information
 - Additional demos
 - Configuration options and sample code for all demos

Managing z/VM and Linux on System z

- **Security**
 - RACF and zSecure Manager for z/VM
- **Performance monitoring**
 - OMEGAMON XE on z/VM and Linux
- **Operational monitoring and automation**
 - Operations Manager for z/VM
 - Including integration with existing monitoring and alert systems
- **Backup and recovery**
 - Backup and Restore Manager for z/VM
 - Tape Manager for z/VM
 - Tivoli Storage Manager
- **Interactive provisioning and system resource management**
 - IBM Wave for z/VM

IBM Wave for z/VM vs Operations Manager for z/VM

- **IBM Wave for z/VM provides an interactive GUI interface for:**
 - Provisioning of Linux guests
 - Basic performance information
 - Monitoring of virtual server resources
- **Operations Manager for z/VM provides operational monitoring & automation**
 - In the background
 - Monitoring of console messages for z/VM service machines and Linux guests
 - Monitoring “state” information for z/VM service machines and Linux guests
 - Monitoring spool and page space on the z/VM system

Hands-on Labs Available

- **Tuesday, 09:30, Platinum Ballroom, Salon 7**
 - **Automation and Backup/Recovery Scenarios for z/VM and Linux on System z Using IBM Solutions**
 - **Operations Manager for z/VM**
 - **Backup and Restore Manager for z/VM**

Recommended Practices – Operational Management

View and issue commands on consoles of Linux guests and CMS service machines

- Operations staff monitoring multiple consoles or a central console of alerts
- System programmers debugging a problem on a guest or service machine

Generate alerts and/or automatically recover from

- Abend, termination, or error messages
- Service machine disks approaching full
- Critical user IDs or guests being logged off or entering error state
- Spool and/or page space approaching full

Schedule automated system maintenance procedures

- Spool cleanup based on policies
- Minidisk cleanup (from logs), including archiving
- Orderly startup and shutdown
 - Relocation of critical guests to another SSI member
- Backups of z/VM system

Automation Demos Available

1. **Send an e-mail based on a console message**
2. **Send an alert to Netcool/OMNIBus based on a console message, hold and unhold messages**
 - a. Using POSTZMSG interface to Netcool/OMNIBus
 - b. Using SNMP interface to Netcool/OMNIBus
3. **Send a message or email if spool approaches full**
 - a. Send a message if spool usage is too high on any member of an SSI Cluster
 - b. Send an email if spool usage is too high on a single system
4. **View and clean up spool files**
5. **Automated spool cleanup**
6. **Archiving DIRMAINT's log files when disk gets full**
7. **Process a file of test messages as a console**
8. **Process Linux syslog data as a console**
9. **Create a central operations console on one z/VM system**
10. **Create a central operations console across multiple z/VM systems**
 - a. When the systems are in an SSI cluster
 - b. When the systems are not in an SSI cluster
11. **Integration with OMEGAMON XE on z/VM and Linux - take action based on CPU usage of Linux guest**
12. **Monitor service machines for logoff – and autolog them**
13. **Send an email if page space approaches full**
14. **Monitor SSI connectivity between 2 cluster members**
15. **Suppress passwords on Linux consoles**
16. **Autolog a Linux Guest and Send Message if Doesn't Start Successfully**
17. **View consoles of Linux guests, Linux syslog data, and CMS user IDs or service machines**



IBM Software

Product Overview

IBM Operations Manager for z/VM

Operations Manager for z/VM

Increase productivity

- Authorized users to view and interact with monitored virtual machines without logging onto them
- Multiple users view/interact with a virtual machine simultaneously

Improve system availability

- Monitor virtual machines and processes
- Take automated actions based on console messages
- Reduce problems due to operator error

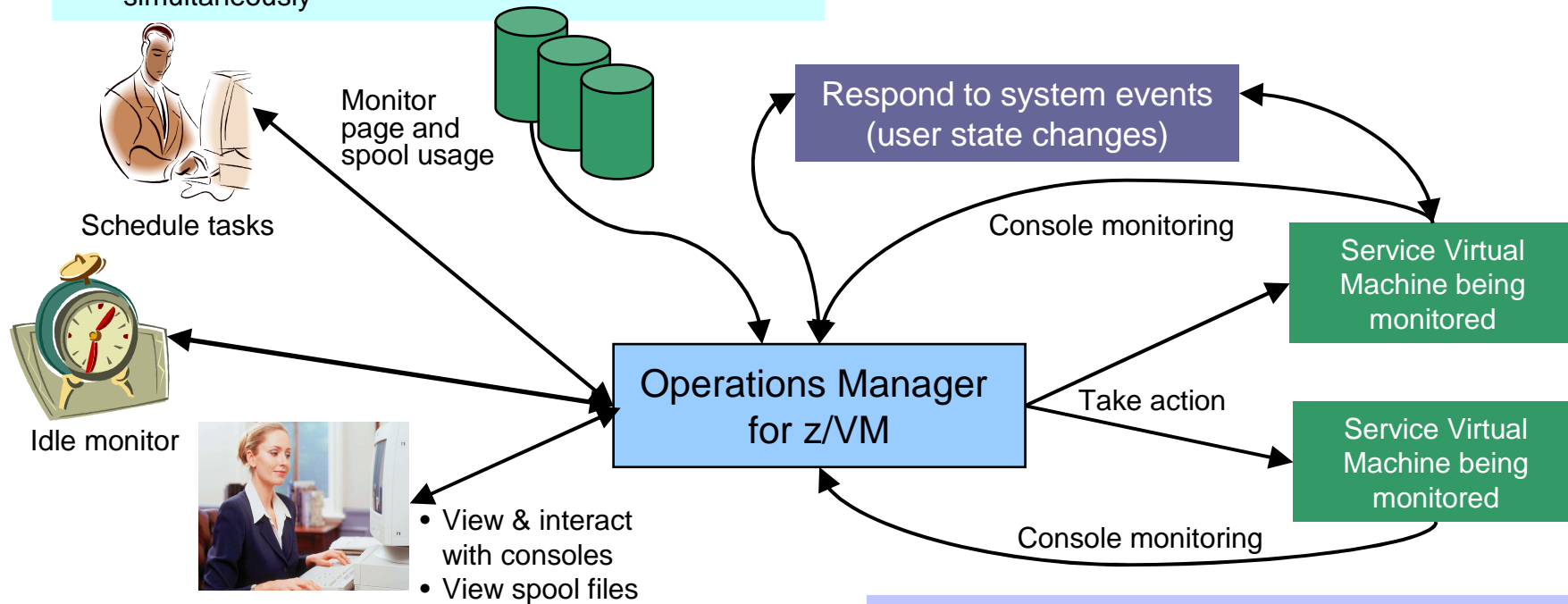

Automation

- Routine activities done more effectively with minimal operations staff
- Schedule tasks to occur on a regular basis

Integration

- Fulfill take action requests from performance monitoring products (e.g. OMEGAMON XE on z/VM and Linux)
- Send alerts to email, central event management systems (e.g. Netcool/OMNibus), etc.

Features and Functions

- **Monitor service machine consoles**
- **Monitor page space and spool usage**
- **Monitor system events**
- **Schedule events/actions**
- **Take actions automatically based on monitoring results**
- **View and interact with monitored consoles from authorized user IDs**
- **Find and view spool files**
- **Dynamic configuration**
- **Separation of access control**

Dynamic Configuration

- **Initial configuration file loaded at startup**
 - May imbed other configuration files
 - Filename can be a substitution variable for the system name
- **Most configuration options can be updated while Operations Manager is running**
 - Add, delete, or change:
 - Rules, actions, monitors, schedules, holidays, groups, user authorization
 - Suspend or resume rules, monitors, schedules
- **Multiple methods**
 - CMS command interface
 - (Re)load a new or updated configuration file
 - Commands in action routines
- **Sample configuration files provided**
 - Includes some of the demos in this presentation
 - Operations Manager configuration statements
 - Sample REXX code



IBM Software

View and Issue Commands on Consoles

Linux Guests and CMS Service Machines

Generate Alerts and/or Automatically Recover From

Abend Messages

Termination Messages

Error Messages

Monitor Service Machine Consoles

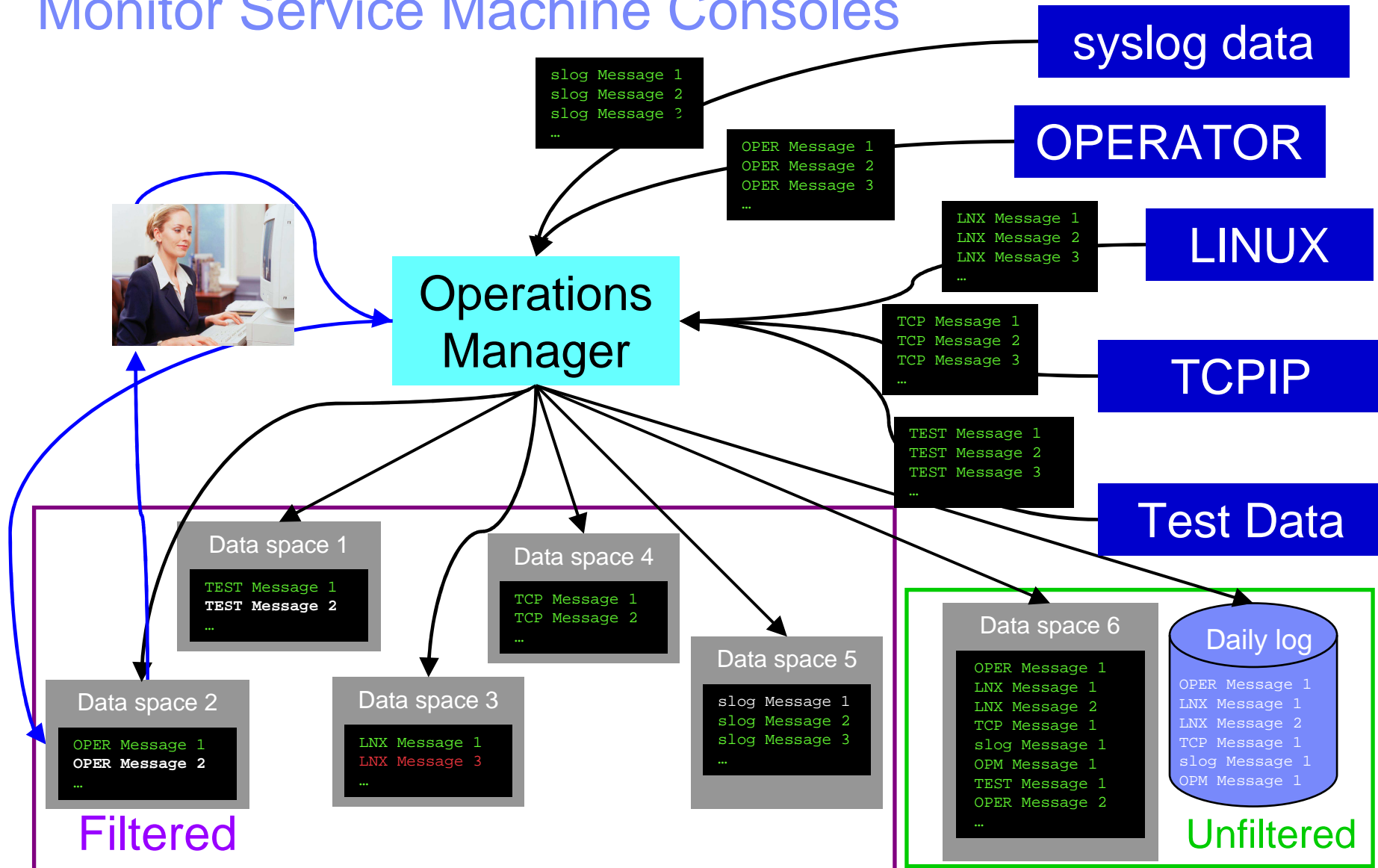

View and Interact with Consoles

- **Authorized users can view live consoles of monitored service machines & guests**
 - Multiple users can view the same console simultaneously
 - No need to logon to the user ID to see its console
 - No interruption of the user ID
 - No need to create and close console files of disjointed data
 - Test data and Linux syslog data treated as a “console”
 - Views can be defined to look at a group of consoles in one view
 - **Can specify a date and time range for your view within currently available data**
 - Can request a copy of the current console data for a user or set of users
 - **Format of date in the view is based on requestor’s CP DATEFORMAT setting**
- **Full screen mode**
 - Scroll up and down to view and search historical data
 - Auto scroll (on or off) as new output is displayed on the console
 - From command line, issue commands back to the monitored console
- **Amount of data that is visible depends on specified or default data space size**
 - **Or date/time range specified**
- **Rules/actions may modify the view**
 - Suppress messages from the console
 - Hold or highlight messages with color, blinking, etc.
- **Authorized users can view the log file**
 - Can also request a copy of the log file from today or a previous day

Monitor Service Machines

- **Define rules to**
 - Scan console messages for text matching
 - Includes column, wildcard, and exclusion support
 - Optionally restrict to specific user ID(s)
 - Take actions based on matches
- **Multiple rules can apply to one message**
 - Rules processed in order of definition in the configuration file
 - FINAL option available to indicate no additional rules should be evaluated

Executing Actions

- **Define action(s) to be triggered**
 - Specify action to take as part of the console rule definition
 - Action is taken when match is found
 - Types of actions
 - Change color, highlight, hold, or suppress a console message
 - CP or CMS commands
 - REXX EXECs
 - Write data out on a TCP/IP port
 - E.g. send data to a syslog daemon/server
- **Dynamically include data about the triggering event in the action**
 - Available to the action via substitution variables
- **Take multiple actions based on one message**
 - Chain actions together
 - Limit the number of times an action is taken in a specified period of time



IBM Software

Generate Alerts and/or Automatically Recover From

Critical User IDs or Guests Logging Off
Critical User IDs or Guests Enter Error State

Respond to System Events

- **Create monitors for z/VM system events (*VMEVENT) related to user IDs**
 - Class 0
 - 0 - Logon
 - 1 - Logoff
 - 2 - Failure condition (including CP READ and Disabled Wait)
 - 3 - Logoff timeout started
 - 4 - Forced sleep started
 - 5 - Runnable state entered (VM READ)
 - 6 - Free storage limit exceeded
 - 9 - Outbound relocation started
 - 10 - Inbound relocation started
 - 11 - Outbound relocation complete
 - 12 - Inbound relocation complete
 - 13 - Outbound relocation terminated
 - 14 - Inbound relocation terminated
 - 15 – Timebomb exploded
- **Additional classes also supported**
- **Optionally restrict to specific user ID(s)**
- **Specify the action associated with the event**
 - Actions specified are the same as those for schedules, console rules, and other monitors



IBM Software

Generate Alerts and/or Automatically Recover From

Spool Space Approaching Full
Page Space Approaching Full

Monitor Page and Spool Usage, View Spool Files

- **Create page and spool space monitors to trigger actions when**
 - Percent of spool usage falls within a specified range
 - Percent of spool usage increases at a specified rate
 - Percent of page space usage falls within a specified range
 - Percent of page space usage increases at a specified rate
- **Actions triggered can be the same actions used by console monitoring**
- **For spool files, authorized users can**
 - Display a list of spool files based on one or more attributes
 - Owner
 - Size
 - Date created
 - From the list, the user can
 - Sort the list on any of the available columns
 - View the contents of an individual spool file
 - Purge, transfer, or change a spool file



IBM Software

Schedule Automated System Maintenance Procedures

Monitor for Rules, Monitors and Schedules that Were Not Triggered

Spool Cleanup Based on Policies

Backups

Disk Cleanup

Orderly Startup and Shutdown

Schedule Events and Actions

- **Define schedules**
 - Hourly, daily, weekly, monthly, or yearly, nth weekday of the month
 - Once on specified month, day, year, and time
 - Based on ISO week definitions (week number; even, odd, first, last week)
 - At regular intervals
 - Every x hours and y minutes
 - Within a specified window of time
 - Specify start time
 - Specify conflicting schedules
 - Specify maximum time to defer this schedule
 - Within limits
 - Restrict to specific days of the week: Monday through Sunday plus holidays
 - Restrict to certain hours of the day

- **Specify the action associated with the schedule**
 - Actions specified are the same as those for console rules and all other monitors

Idle Monitors

- **Define idle monitors**
 - Watch for idle rules, schedules, and monitors
 - Rule, schedule, or monitor **not** triggered ***n*** number of times within specified period of time
- **Specify the action associated with the idle monitor**
 - Actions specified are the same as those for schedules, console rules, other monitors



IBM Software

SSI vs non-SSI Considerations

Operations Manager - non-SSI Environment

Remote system
(z/VM, email,
Netcool\OMNibus, etc.)

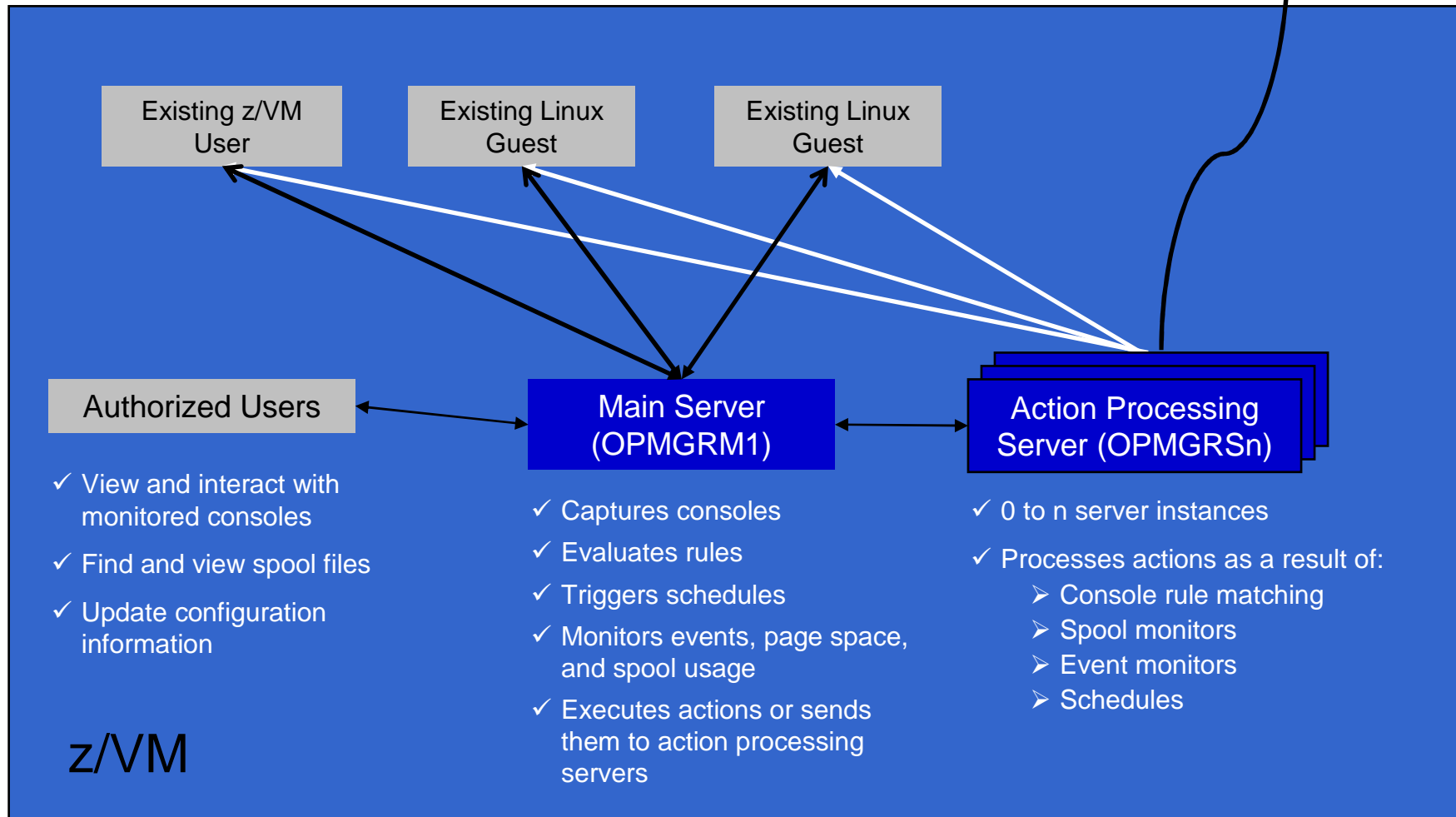



IBM Software

SSI Considerations

Console Monitoring

Single Config User

Multiconfig User

SSI Considerations for Console Monitoring

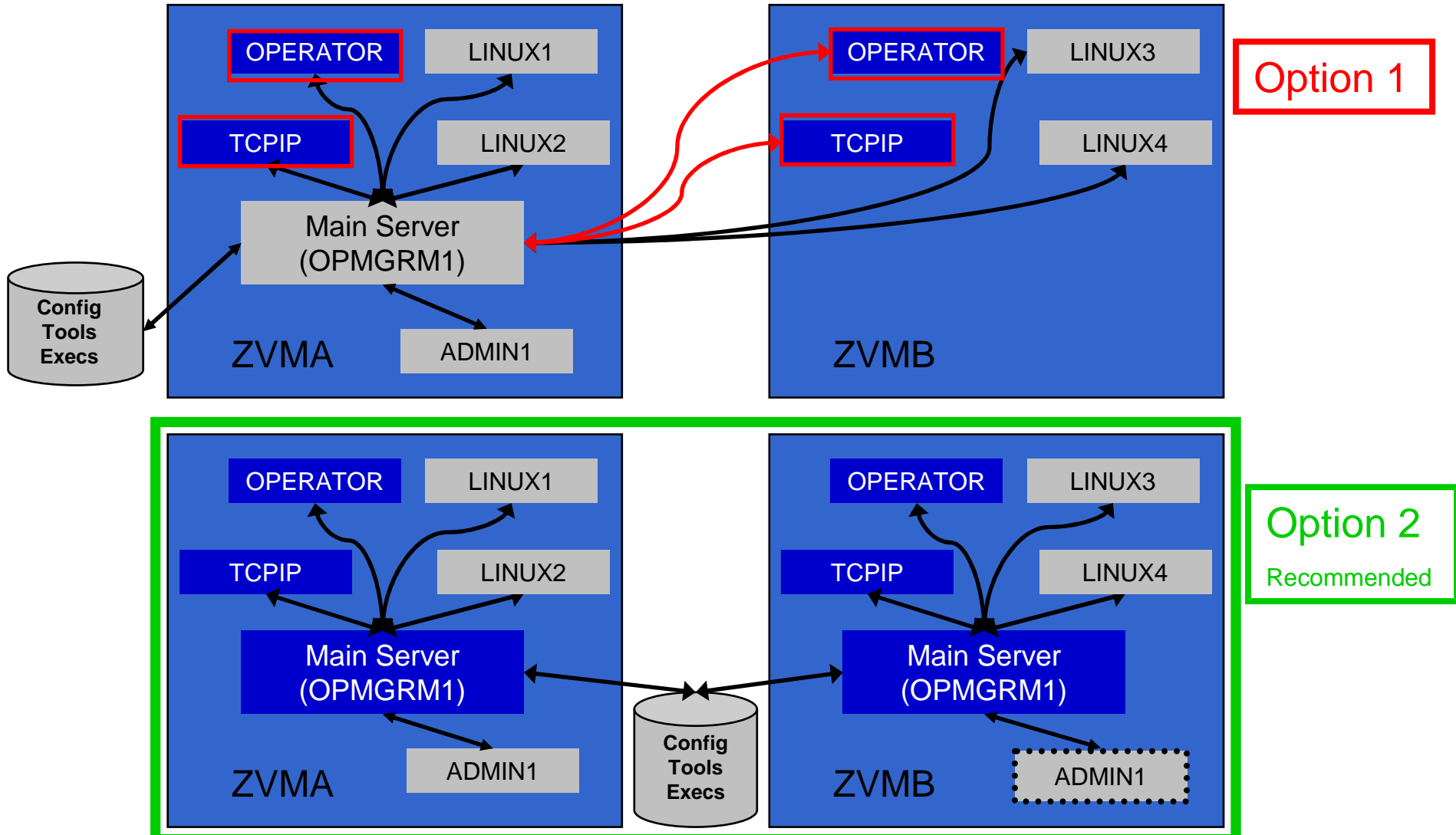

Operations Manager in SSI Cluster - Example

- Multiconfiguration users: OPMGRM1, OPMGRSn, OPERATOR, MAINT
- Single configuration users: RHEL5G, SLES11C, OPERSSI, DEMOADMN
 - May relocate OPERSSI and DEMOADMN manually (supported) or via VMRELOCATE (unsupported, but you can make it work)

Remote system
(z/VM, email,
Netcool\OMNibus, etc.)

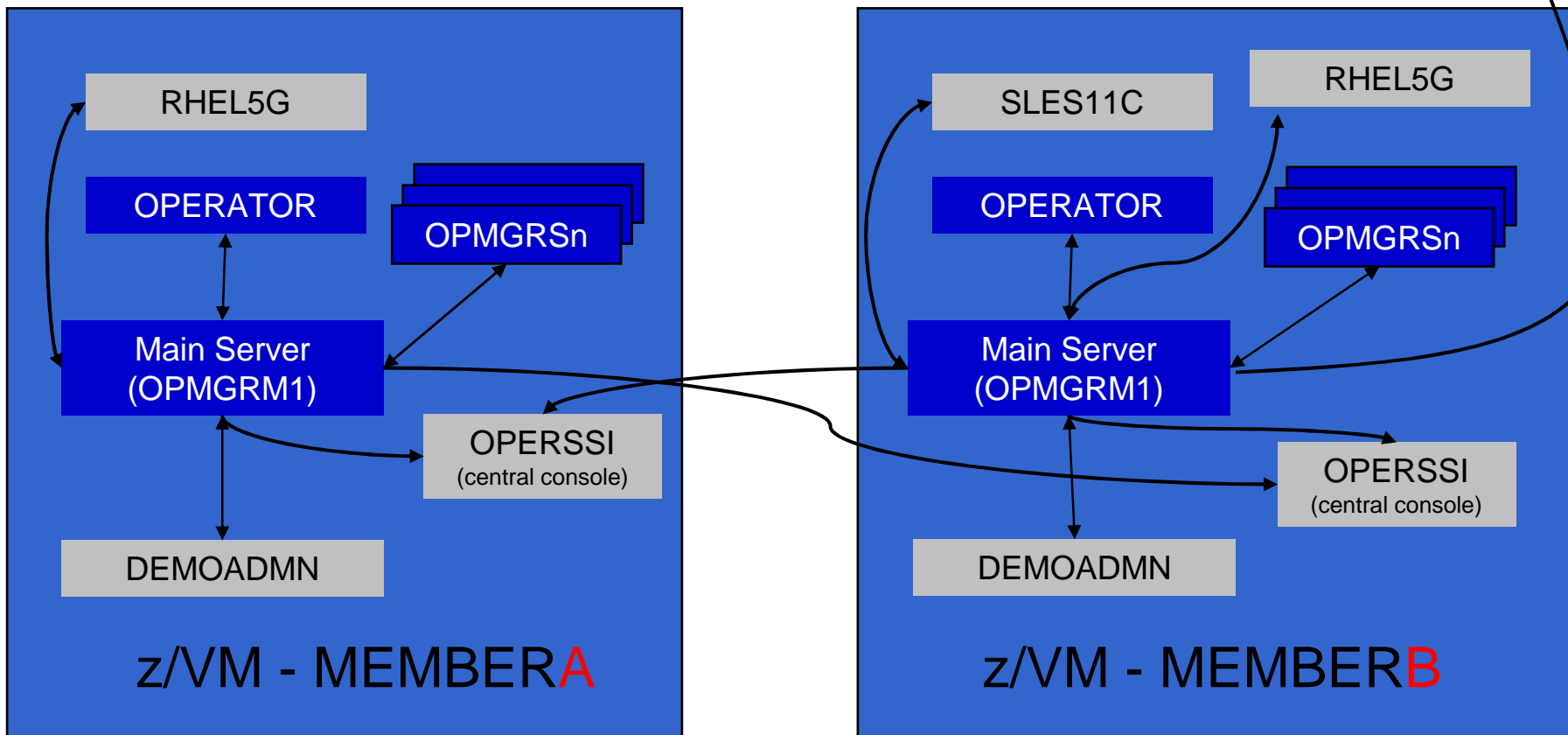

Relocating OPERSSI and DEMOADMN (CMS Users) ...

- **VMRELOCATE for CMS user IDs not officially supported**
- **Can be done for some CMS users**
 - Create single configuration user ID for z/VM system disks
 - Copy MAINT 190, 19D, 19E to minidisks owned by this new user ID
 - Relocateable CMS user must IPL from identical NSS (CMS) or minidisk (190)
 - Use SPXTAPE to copy CMS NSS
 - VMRELOCATE uses checksum of NSS to determine if identical
 - CMS NSS includes date/time it was loaded
 - Or, have relocateable CMS users IPL 190 instead of IPL CMS

OPERSSI DIRECT

```
USER OPERSSI ...
...
OPTION CHPIDVIRTUALIZATION ONE
...
IPL 190
...
LINK CMAINT 0190 0190 RR
LINK CMAINT 019D 019D RR
LINK CMAINT 019E 019E RR
...
```

PROFILE EXEC

```
/* PROFILE EXEC for OPERSSI */
...
'SET RELPAGE OFF'
...
```

... Relocating OPERSSI and DEMOADMN (CMS Users)

■ Beware

- It's worth repeating ... **VMRELOCATE for CMS user IDs not officially supported**
- All members of the cluster must be kept at same z/VM (or at least CMS) code level
- If IPL 190, will use more memory as each user ID will have private copy of CMS
- SET RELPAGE OFF may have a negative impact on overall system performance
- Only works for “basic” CMS users
 - All relocation rules still apply
 - E.g. user IDs connecting to VMCF or IUCV can't relocate

Monitor Service Machines - Considerations

- **Consoles received by Operations Manager via SECUSER or OBSERVER**
 - Prefer SECUSER
 - OBSERVER won't detect CP and VM READ messages
 - Output of actions on OBSERVED console may not be viewable in console
 - OBSERVER allows Operations Manager to receive console output even if user is logged on
- **Single System Image allows SECUSER and OBSERVER across members of cluster**
 - Content does not contain member name information
 - Rules, actions, and users wouldn't be able to distinguish between IDENTITY users on multiple members
 - Creates single point of failure on one member
- **Recommendation for z/VM V6.2 or V6.3 Single System Image environments**
 - Have all consoles monitored by an Operations Manager server on the same member as the monitored guest (i.e. all Operations Manager servers are IDENTITY users)
 - Requires action processing servers (OPMGRS_n) to be on same member as main server
 - Share configuration data on minidisk owned by single configuration user
 - For example: VMTOOLS 198
 - Master configuration file unique to each member
 - Imbed common file(s) used by all members
 - Request a copy of the current console of a remote user
 - `SMSG OPMGRM1 at membername VIEWCON USER(userid),MODE(RDR)`



IBM Software

SSI Considerations

Page Space Monitoring

Spool Space Monitoring

Viewing and Managing Spool Files

SSI Considerations for Spool and Page Space Monitoring

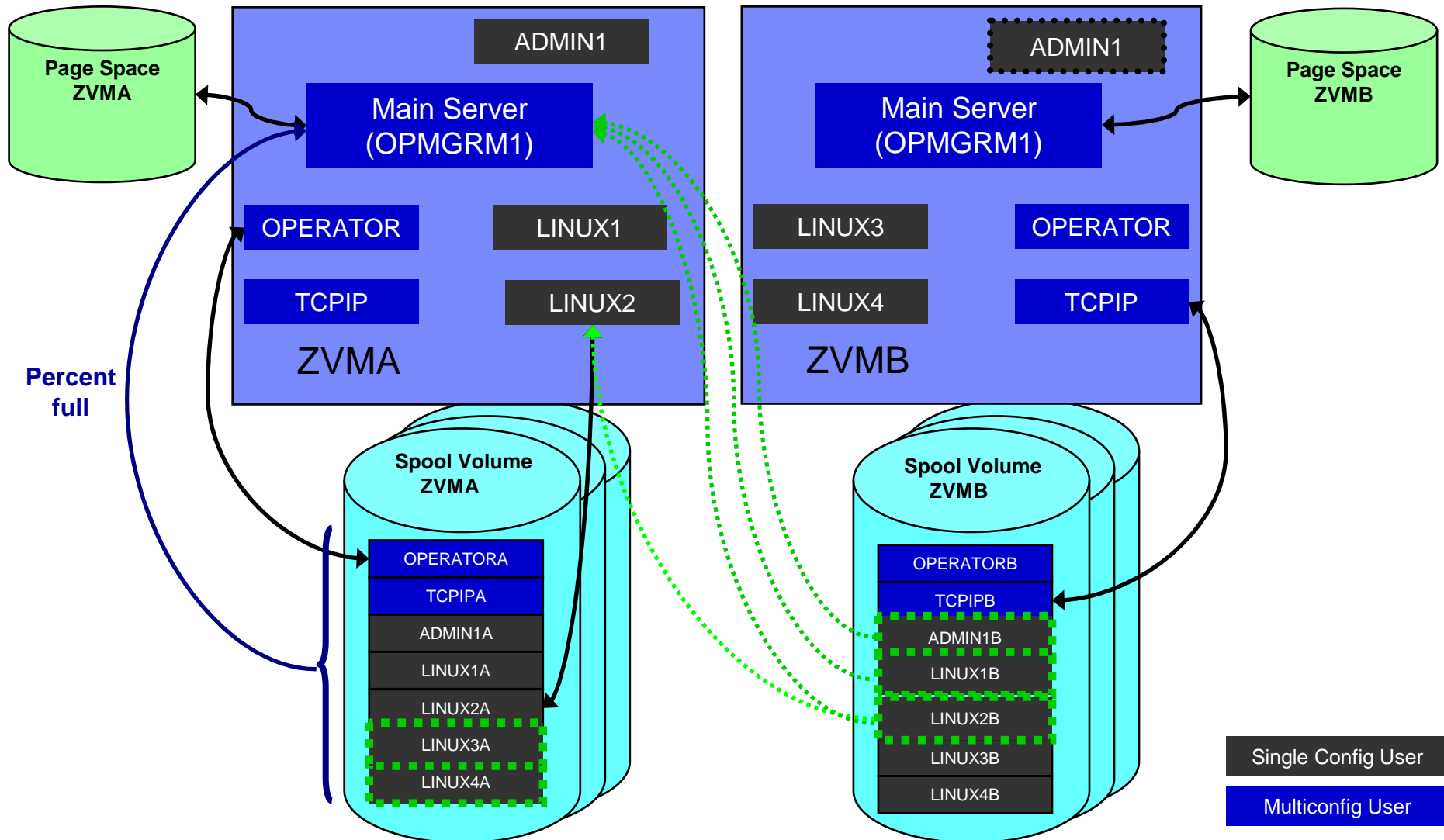

Spool and Page Space Monitoring - Considerations

- **Page space is local**
 - Separate space for each member and only visible to the local member
 - No impact from SSI
- **Spool data**
 - Spool files are placed on spool volumes owned by the member where the spool file was created
 - Users see their own spool data no matter where they are logged on and where the data was created

Spool and Page Space Monitoring - Considerations

- **Users and applications (like Operations Manager) who can see all spool files need to be aware:**
 - Spool data for multiconfiguration users
 - Only spool files owned by the local instance of that user are visible on the local member
 - No visibility to spool files owned by other instances of that user on other members
 - Spool data for single configuration users:

Single configuration user Status	Spool files created on <u>this</u> member	Spool files created on <u>other</u> members
User logged off	Visible	Not visible
User logged onto <u>this</u> member	Visible	Visible (but not on local spool volumes)
User logged onto <u>another</u> member	Visible	Not visible

Spool and Page Space Monitoring - Considerations

■ Recommendation

- Have an Operations Manager server on each member to monitor spool and page space
- Be aware of spool files visible in Operations Manager but not resident on this member's spool volumes
 - Indicated with "+" in VIEWSPPL



IBM Software

SSI Considerations

Managing Configuration Files

Managing Configuration Files

- **Put all configuration files on a shared disk**
 - Minidisk owned by a single configuration user (not an Operations Manager service machine)
 - SFS
- **Create a common configuration file used by all members**
 - All Operations Manager servers on all members load this file
- **Imbed a unique configuration file based on the system name of this member**
- **Request configuration file reload from user IDs on other members of a cluster**
 - Use SMSG OPMGR1 at <member> CONFIG ...

OPMGRM1 CONFIG E

* Common configuration for all member of the cluster

 CONFIG FN(&SYSNAME),FT(CONFIG),FM(E)

MEMBERA CONFIG E

* Configuration specific to MEMBERA system
 ...

MEMBERB CONFIG E

* Configuration specific to MEMBERB system
 ...



IBM Software

Summary

References

Demos – Including Screenshots, Configuration Statements, and REXX

Recommended Practices – Operational Management

View and issue commands on consoles of Linux guests and CMS service machines

- Operations staff monitoring multiple consoles or a central console of alerts
- System programmers debugging a problem on a guest or service machine

VIEWCON

Generate alerts and/or automatically recover from

- Abend, termination, or error messages
- Service machine disks approaching full
- Critical user IDs or guests being logged off or entering error state
- Spool and/or page space approaching full

Schedules

Event monitors

Rules

Spool/Page monitors

Schedules

Schedule automated system maintenance procedures

- Spool cleanup based on policies
- Minidisk cleanup (from logs), including archiving
- Orderly startup and shutdown
 - Relocation of critical guests to another SSI member
- Backups of z/VM system

Rules, Archive Mgr

SFPURGER

Rules, monitors

Backup Manager

Summary

- **Use Operations Manager to**
 - Automate daily operations
 - Integrate your z/VM and Linux on System z environment with existing enterprise monitoring and alerting
 - Prevent problems rather than react to them
 - Automate reactions to problems when they can't be prevented
 - Improve problem determination procedures
 - Increase programmer and operator productivity
 - Continue to monitor locally with improved management of clusters
- **Sometimes several alternatives for monitoring for the same event**
 - Console message (rules)
 - Scheduled healthchecks (schedules)
 - User ID status changes (event monitor)
- **Actions allow integration with other platforms and products**

Reference Information

- **Product Web site**

- Start at <http://www.ibm.com/software/stormgmt/zvm/>
- Product pages include
 - Publications
 - Pre-requisites
 - Presentations
 - White papers
 - Support

- **e-mail**

- Mike Sine, sine@us.ibm.com, Advanced Technical Skills (ATS)
- Tracy Dean, tld1@us.ibm.com, Product Manager

- **White papers on Operations Manager website (Resources tab)**

- Routing Linux syslog data
- Sending alerts from Operations Manager to Netcool/OMNIBus
- Using Shared File System to store Operations Manager configuration files and automation EXECs
- Automatically logging on a user at Linux system boot time for easier console management and action execution



IBM Software

Demonstration Scenarios

Automation Demos Available

- 1. Send an e-mail based on a console message**
- 2. Send an alert to Netcool/OMNibus based on a console message, hold and unhold messages**
 - a. Using POSTZMSG interface to Netcool/OMNibus
 - b. Using SNMP interface to Netcool/OMNibus
- 3. Send a message or email if spool approaches full**
 - a. Send a message if spool usage is too high on any member of an SSI Cluster
 - b. Send an email if spool usage is too high on a single system
- 4. View and clean up spool files**
- 5. Automated spool cleanup**
- 6. Archiving DIRMAINT's log files when disk gets full**
- 7. Process a file of test messages as a console**
- 8. Process Linux syslog data as a console**
- 9. Create a central operations console on one z/VM system**
- 10. Create a central operations console across multiple z/VM systems**
 - a. When the systems are in an SSI cluster
 - b. When the systems are not in an SSI cluster
- 11. Integration with OMEGAMON XE on z/VM and Linux - take action based on CPU usage of Linux guest**
- 12. Monitor service machines for logoff – and autolog them**
- 13. Send an email if page space approaches full**
- 14. Monitor SSI connectivity between 2 cluster members**
- 15. Suppress passwords on Linux consoles**
- 16. Autolog a Linux Guest and Send Message if Doesn't Start Successfully**
- 17. View consoles of Linux guests, Linux syslog data, and CMS user IDs or service machines**

Scenario 1:

Send an Email if Abend or Fatal Message Occurs

- **Watch all monitored consoles for an error message that includes the word “fatal” or “abend”**
 - Message must also contain the word “mail” (for demo purposes only)
- **Send an email if one of the words appears on a console**
- **Dynamically include in the email**
 - Host name of z/VM system where the error occurred
 - User ID that received the error message
 - Indicator of whether the word was fatal or abend
 - Full text of the error message

Scenario 1: Detailed Steps

- **From any VM user ID:**

```
tell opmgrc1 this is an abend message from SHARE. Send an e-mail, please.
```

- **From an authorized VM user ID, view the console of OPMGRC1:**

```
gomcmd opmgrm1 viewcon user(opmgrc1)
```

- **Check the inbox of the appropriate person to see the e-mail**

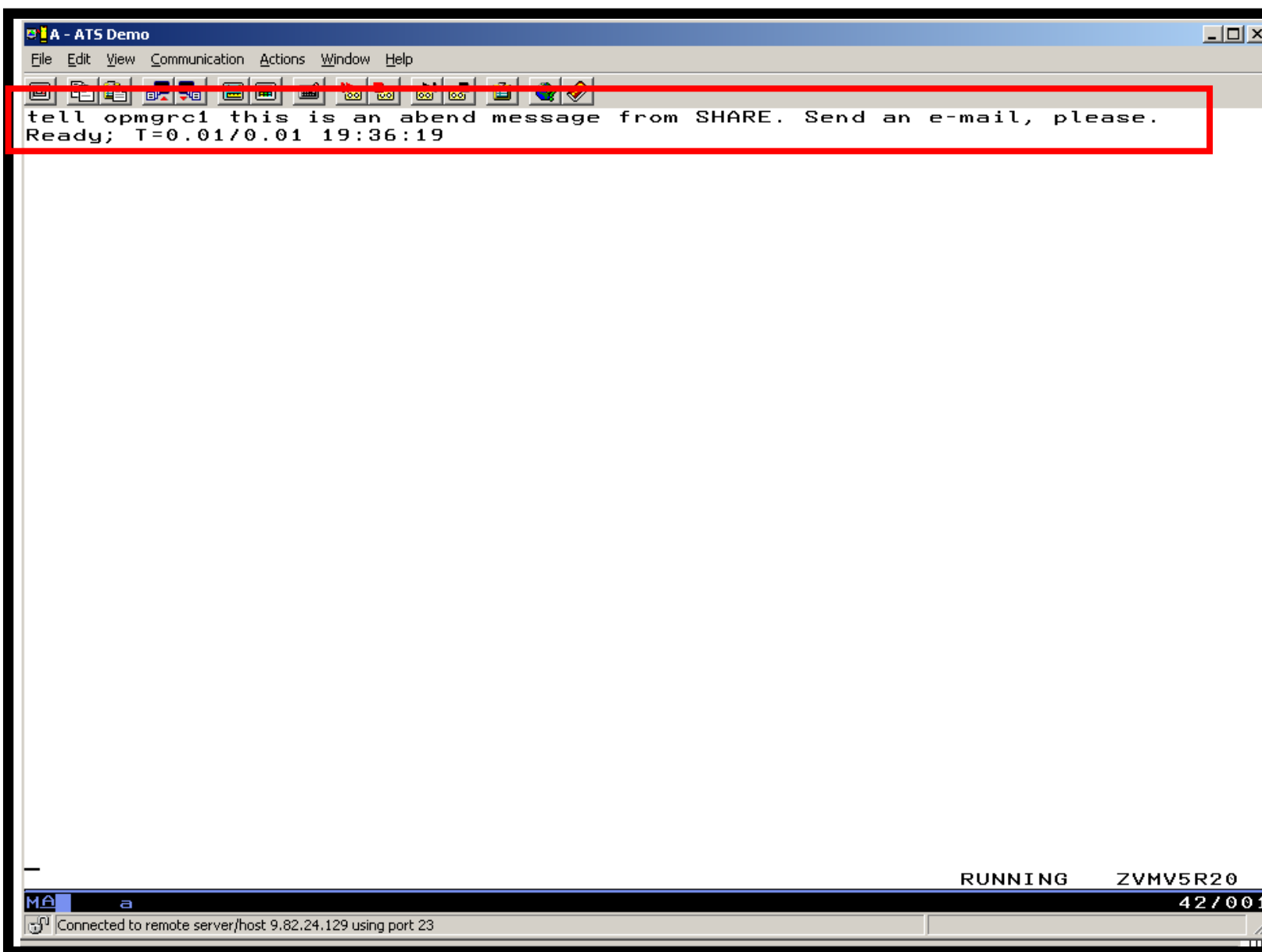

The screenshot shows a terminal window titled "A - ATS Demo". The window has a menu bar with "File", "Edit", "View", "Communication", "Actions", "Window", and "Help". Below the menu bar is a toolbar with various icons. The main area of the terminal displays the following text:

```
tell opmgrcl this is an abend message from SHARE. Send an e-mail, please.  
Ready; T=0.01/0.01 19:36:19
```

The text is enclosed in a red rectangular box. At the bottom of the terminal window, there is a status bar with the following information:

MA a RUNNING ZVMV5R20 42/001
Connected to remote server/host 9.82.24.129 using port 23

```

A - ATS Demo
File Edit View Communication Actions Window Help
23:59:59
00:00:00 HCPMID6001I TIME IS 00:00:00 EST SUNDAY 02/22/09
00:00:00
00:00:03 HCPMID6001I TIME IS 00:00:00 EST MONDAY 02/23/09
00:00:03
10:24:17 * MSG FROM SINE : this is a fatal message
10:24:27 * MSG FROM SINE : this is a fatal message please send an e-mail
10:24:27 * -- Operations Manager Action EMAIL scheduled for execution -- *
10:25:29 * MSG FROM SINE : this is a fatal message please tell omnibus
10:25:29 * -- Operations Manager Action ALRTOMNI scheduled for execution -- *
11:48:50 RDR FILE 0007 SENT FROM SINE PUN WAS 0254 RECS 169K CPY 001 A NOH
12:03:07 RDR FILE 0008 SENT FROM SINE PUN WAS 0256 RECS 169K CPY 001 A NOH
12:03:20 RDR FILE 0009 SENT FROM SINE PUN WAS 0258 RECS 169K CPY 001 A NOH
00:00:01 HCPMID6001I TIME IS 00:00:00 EST TUESDAY 02/24/09
00:00:01
00:51:58 * MSG FROM SINE : test abend message for omnibus
00:51:58 * -- Operations Manager Action ALRTOMNI scheduled for execution -- *
00:55:15 * MSG FROM SINE : test abend message for omnibus
00:55:15 * -- Operations Manager Action ALRTOMNI scheduled for execution -- *
00:55:41 * MSG FROM SINE : test abend message for omnibus
00:55:41 * -- Operations Manager Action ALRTOMNI scheduled for execution -- *
00:56:25 * MSG FROM SINE : test fatal message for omnibus
00:56:25 * -- Operations Manager Action ALRTOMNI scheduled for execution -- *
00:58:05 * MSG FROM SINE : test fatal message for omnibus
00:58:05 * -- Operations Manager Action ALRTOMNI scheduled for execution -- *
01:01:47 * MSG FROM SINE : test fatal message for omnibus
01:01:47 * -- Operations Manager Action ALRTOMNI scheduled for execution -- *
01:02:36 * MSG FROM SINE : test fatal message for omnibus
01:02:36 * -- Operations Manager Action ALRTOMNI scheduled for execution -- *
01:03:31 * MSG FROM SINE : test fatal message for omnibus
01:03:31 * -- Operations Manager Action ALRTOMNI scheduled for execution -- *
01:04:00 * MSG FROM SINE : test abend error for omnibus
01:04:00 * -- Operations Manager Action ALRTOMNI scheduled for execution -- *
14:01:16 * MSG FROM SINE : test fatal error for omnibus
14:01:16 * -- Operations Manager Action ALRTOMNI scheduled for execution -- *
14:05:33 * MSG FROM SINE : test abend error for omnibus
14:05:33 * -- Operations Manager Action ALRTOMNI scheduled for execution -- *
14:13:43 * MSG FROM SINE : test fatal error for omnibus
14:13:43 * -- Operations Manager Action ALRTOMNI scheduled for execution -- *
19:36:18 * MSG FROM SINE : this is an abend message from SHARE. Send an e-m
19:36:18 * -- Operations Manager Action EMAIL scheduled for execution -- *
-
MA a OPMGRC1 (Scroll) 42/001
Connected to remote server/host 9.82.24.129 using port 23

```

The screenshot shows the IBM Lotus Notes Mail interface for Tracy Dean. The search bar contains 'holly' and the results are filtered to show a 'Normal' priority email from OPMGRM1 on 02/24/2009 at 04:36 PM. The subject is 'Abend on user ID OPMGRC1 on z/VM system'. Other emails from Steve Wilkins and Marcy Cortes are also visible.

Who	Date	Time	Size	Subject
OPMGRM1	02/24/2009	04:36 PM	3,066	Abend on user ID OPMGRC1 on z/VM system
Steve Wilkins	02/24/2009	04:03 PM	21,907	Re: Clear_Tdisk question
Marcy Cortes	02/24/2009	04:02 PM	11,358	Re: Clear_Tdisk question

OPMGRM1@MSINE.WASHINGTON.IBM.COM
02/24/2009 11:36 AM
Default custom expiration date of 02/24/2010

To: Tracy Dean/Beaverton/IBM@IBMUS
cc:
bcc:
Subject: Abend on user ID OPMGRC1 on z/VM system

The following message was received on OPMGRC1 running on MSINE.WASHINGTON.IBM.COM :
* MSG FROM SINE : this is an abend message from SHARE. Send an e-mail, please.

DO NOT REPLY - This e-mail was generated by an automated service machine

Scenario 1: How Do You Do That?

Rules in Operations Manager:

```
*  
* Send an e-mail to someone if I see a message containing the word  
* "fatal" on any monitored console
```

```
DEFRULE NAME(FATLMAIL),+  
  MATCH(*FATAL*mail*),+  
  ACTION(EMAIL),+  
  PARM(FATAL)
```

```
*  
* Send an e-mail to someone if I see a message containing the word  
* "abend" on any monitored console
```

```
DEFRULE NAME(ABNDMAIL),+  
  MATCH(*ABEND*mail*),+  
  ACTION(EMAIL),+  
  PARM(ABEND)
```

Scenario 1: How Do You Do That?

Action in Operations Manager:

*

* Replace "tld1 at us.ibm.com" with the e-mail address of the user that

* should receive the e-mail

* Leave &u, &p, and &t as-is. These represent the user ID that had the

* "fatal" message, the parameter passed (fatal orabend), and the

* text of the message. These will be included in the text of the

* e-mail.

```
DEFACTN NAME(EMAIL),+
```

```
COMMAND(EXEC SMTPNOTE tld1 at us.ibm.com &u &p &t),+
```

```
OUTPUT(LOG),+
```

```
ENV(LVM)
```

Scenario 1: How Do You Do That?

SMTPTNOTE EXEC (excerpts)

```
/* */
Parse arg mail_user 'AT' mail_node baduser errtype msgtext
if errtype = 'FATAL' then
  errrtext = 'Fatal error on user ID' baduser 'on z/VM system'
else
  if errtype = 'ABEND' then
    errrtext = 'Abend on user ID' baduser 'on z/VM system'
  else errrtext = msgtext
/* Construct the e-mail */
line.1 = 'OPTIONS: NOACK    LOG    SHORT    NONOTEBOOK ALL CLASS A'
line.2 = 'Date: ' Date() ', ' Time()
line.3 = 'From: Operations Manager for z/VM'
line.4 = 'To: ' mail_user 'at' mail_node
line.5 = 'Subject: ' errrtext
line.6 = 'The following message was received on' baduser 'running on'
line.7 = msgtext
line.8 = ' '
line.9 = 'DO NOT REPLY - This e-mail was generated by an automated service machine'
line.0 = 9
'PIPE stem line. | > TEMP NOTE A'
'EXEC SENDFILE TEMP NOTE A (NOTE SMTP'
```

Scenario 2a:

Send an Alert to OMNIbus – Using POSTZMSG

- **Watch all monitored consoles for an error message that includes the word “fatal” or “abend”**
 - Message must also contain the word “omni” (for demo purposes only)
- **Send an alert to OMNIbus if one of the words appears on a console**
 - Use POSTZMSG, running on Linux guest
 - Do not trigger the action if the message is on this guest
- **Dynamically include in the alert**
 - User ID that received the error message
 - Indicator of whether the word was fatal or abend

Scenario 2a: Detailed Steps

- **View “All Events” in OMNibus**

- **From any VM user ID:**

```
tell opmgrc1 this user is abending at SHARE. Tell OMNIBUS.
```

- **From an authorized VM user ID, view the console of OPMGRC1:**

```
gomcmd opmgrm1 viewcon user(opmgrc1)
```

- **From an authorized VM user ID, view the console of the Linux guest that runs POSTZMSG:**

```
gomcmd opmgrm1 viewcon user(esmts112)
```

- **View the OMNibus console to see the alert**

```
A - ATS Demo
File Edit View Communication Actions Window Help
Ready; T=0.01/0.01 20:10:47
tell opmgrc1 this user is abending at SHARE. Tell OMNIBUS.
Ready; T=0.01/0.01 20:10:52

RUNNING ZVMV5R20
42/001
Connected to remote server/host 9.82.24.129 using port 23
```

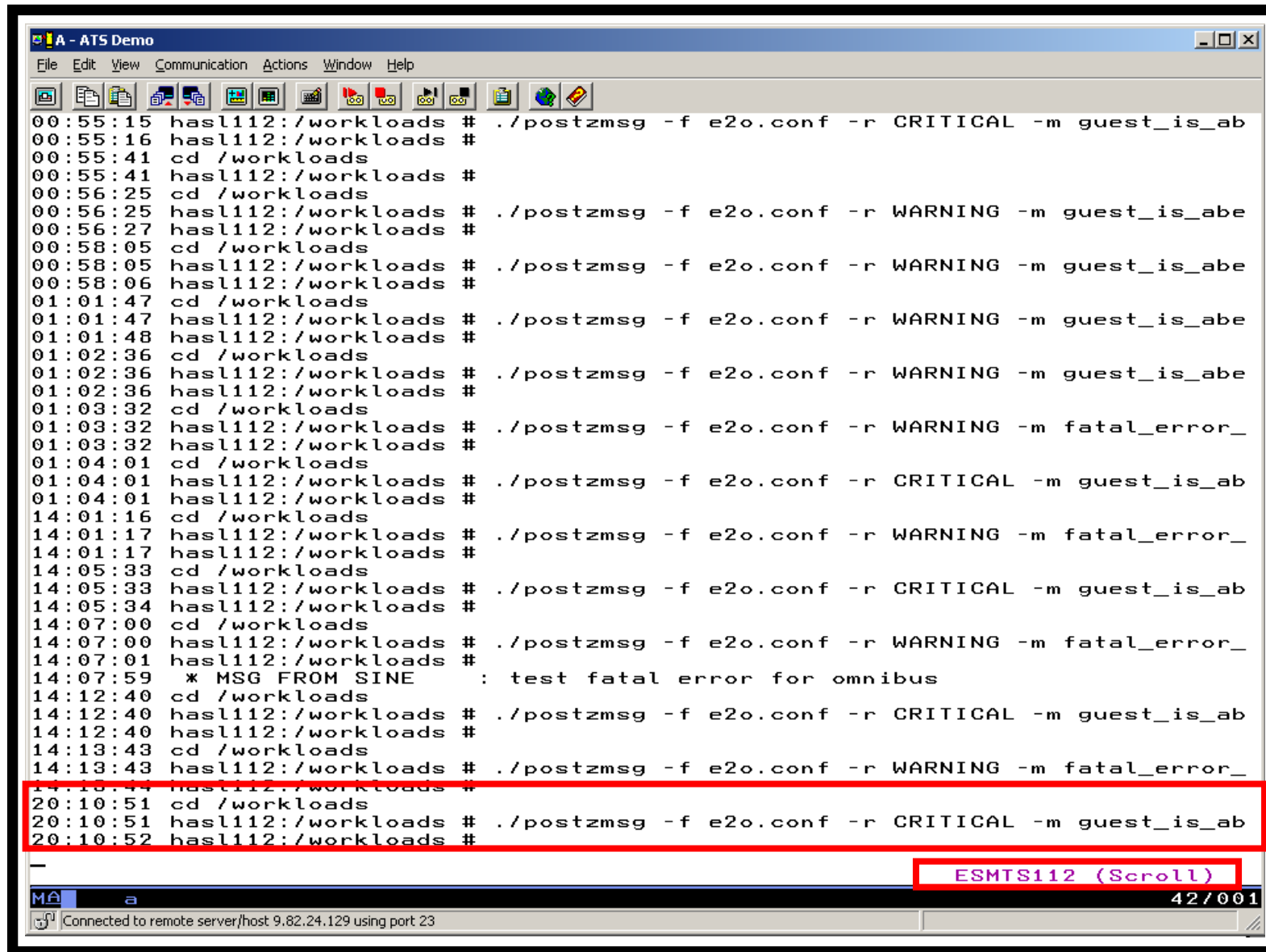

```
A - ATS Demo
File Edit View Communication Actions Window Help
00:55:15 hasl112:/workloads # ./postzmsg -f e2o.conf -r CRITICAL -m guest_is_ab
00:55:16 hasl112:/workloads #
00:55:41 cd /workloads
00:55:41 hasl112:/workloads #
00:56:25 cd /workloads
00:56:25 hasl112:/workloads # ./postzmsg -f e2o.conf -r WARNING -m guest_is_abe
00:56:27 hasl112:/workloads #
00:58:05 cd /workloads
00:58:05 hasl112:/workloads # ./postzmsg -f e2o.conf -r WARNING -m guest_is_abe
00:58:06 hasl112:/workloads #
01:01:47 cd /workloads
01:01:47 hasl112:/workloads # ./postzmsg -f e2o.conf -r WARNING -m guest_is_abe
01:01:48 hasl112:/workloads #
01:02:36 cd /workloads
01:02:36 hasl112:/workloads # ./postzmsg -f e2o.conf -r WARNING -m guest_is_abe
01:02:36 hasl112:/workloads #
01:03:32 cd /workloads
01:03:32 hasl112:/workloads # ./postzmsg -f e2o.conf -r WARNING -m fatal_error_
01:03:32 hasl112:/workloads #
01:04:01 cd /workloads
01:04:01 hasl112:/workloads # ./postzmsg -f e2o.conf -r CRITICAL -m guest_is_ab
01:04:01 hasl112:/workloads #
14:01:16 cd /workloads
14:01:17 hasl112:/workloads # ./postzmsg -f e2o.conf -r WARNING -m fatal_error_
14:01:17 hasl112:/workloads #
14:05:33 cd /workloads
14:05:33 hasl112:/workloads # ./postzmsg -f e2o.conf -r CRITICAL -m guest_is_ab
14:05:34 hasl112:/workloads #
14:07:00 cd /workloads
14:07:00 hasl112:/workloads # ./postzmsg -f e2o.conf -r WARNING -m fatal_error_
14:07:01 hasl112:/workloads #
14:07:59 * MSG FROM SINE : test fatal error for omnibus
14:12:40 cd /workloads
14:12:40 hasl112:/workloads # ./postzmsg -f e2o.conf -r CRITICAL -m guest_is_ab
14:12:40 hasl112:/workloads #
14:13:43 cd /workloads
14:13:43 hasl112:/workloads # ./postzmsg -f e2o.conf -r WARNING -m fatal_error_
14:13:44 hasl112:/workloads #
20:10:51 cd /workloads
20:10:51 hasl112:/workloads # ./postzmsg -f e2o.conf -r CRITICAL -m guest_is_ab
20:10:52 hasl112:/workloads #
-
ESMTS112 (Scroll)
42/001
Connected to remote server/host 9.82.24.129 using port 23
```

Netcool/OMNIBus Event List : Filter="All Events", View="Default"

File Edit View Alerts Tools Help

All Events Default Top [OFF]

Host	Host Group	Summary	Last Occurrence	Count	Prob
OPMGRCI	SCARY_EVENT	guest_is_abending	/24/2009 08:10:52 P	1	Prob
hasl112	TEST_EVENT	Test message from hasl112	/12/2009 02:19:19 P	3	Prob
mwb161	Administrator	Attempt to login as root from host mwb161 failed	/06/2009 06:19:51 P	1	Prob
hasl112	TEST_EVENT	Test message from hasl112	/12/2009 02:15:45 P	3	Prob
hasl112	MWBTEST	Test Message	/05/2009 05:36:58 P	2	Prob
hasle332	Unix Event List	A e@09522621@09522621:1.0 process e@09522621@09522621:1.0 running on ha	/24/2009 08:06:55 P	1	Prob
East	ATS_A_SrvGroup	Server1 experiencing problems	/20/2009 07:23:37 P	3	Prob
	Unix Event List	A e@OmnibusEventConnector process running on has connected as username	/19/2009 09:13:16 P	1	Prob
hasl112	TEST_EVENT	Test message from hasl112	/12/2009 02:19:52 P	1	Prob
	RAD:Impact	A RAD:Impact process running on has connected as username root	/12/2009 09:24:32 A	1	Prob
hasle332	JJELD	A JJELD process running on hasle332 has connected as username root	/05/2009 10:44:58 A	1	Prob
	RAD:Impact	A RAD:Impact process running on has connected as username root	/05/2009 10:44:19 A	1	Prob
hasl125	TESTEIF	test_message_from_eif_2	/19/2008 03:30:51 P	2	Prob
USIBMWZV.HSLV12	TBSMV3_SOURCE390		/25/2008 05:23:22 P	5	Prob
USIBMWZV.HSLV12	TBSMV3_SOURCE390		/25/2008 05:23:21 P	5	Prob
USIBMWZV.HSLV12	TBSMV3_SOURCE390		/05/2008 09:38:25 A	1	Prob
mwbtp	TEST	Test_Message	/10/2008 02:45:57 P	4	Prob

0 4 8 2 1 2 All Events

No rows selected. 02/24/2009 08:11:30 PM root NCOMS[PRI]

Scenario 2a: How Do You Do That?

Rules in Operations Manager:

*
* Send an alert to OMNIBUS for fatal errors on consoles

```
DEFRULE NAME(FATLOMNI),+  
  MATCH(*fatal*omni*),+  
  EXUSER(ESMTS112),+  
  ACTION(ALRTOMNI),+  
  PARM(FATAL)
```

*
* Send an alert to OMNIBUS for abends on consoles

```
DEFRULE NAME(ABNDOMNI),+  
  MATCH(*abend*omni*),+  
  EXUSER(ESMTS112),+  
  ACTION(ALRTOMNI),+  
  PARM(ABEND)
```

Scenario 2a: How Did You Do That?

Action in Operations Manager:

*

* Call POSTZMSG on a Linux guest to send alert to OMNIBUS

```
DEFACTN NAME(ALRTOMNI),+
```

```
COMMAND(EXEC POSTZMSG &u &p),+
```

```
OUTPUT(LOG),+
```

```
ENV(LVM)
```

Scenario 2a: How Did You Do That?

POSTZMSG EXEC (excerpts)

```
/* */
Parse arg baduser errtype
if errtype = 'ABEND' then
  do
    zerrtype = 'CRITICAL'
    cmdpart2 = '-m guest_is_abending hostname='baduser
    cmdpart4 = 'sub_origin=tcp SCARY_EVENT OpsMgr'
  end
else
  do
    zerrtype = 'WARNING'
    cmdpart2 = '-m fatal_error_on_guest hostname='baduser
    cmdpart4 = 'sub_origin=tcp WARN_EVENT OpsMgr'
  end
cmdpart1 = './postzmsg -f e2o.conf -r' zerrtype
cmdpart3 = 'sub_source=postzmsg origin='baduser
'CP SEND ESMTS112 cd /workloads'
'CP SEND ESMTS112' cmdpart1 cmdpart2 cmdpart3 cmdpart4
```

Scenario 2b: Send an Alert to OMNIbus – Using SNMP

- **Watch all monitored consoles for an error message that includes the word “abend”**
 - Message must also contain the word “snmp” (for demo purposes only)
- **If this word appears on a console**
 - Change the message to red and hold it
 - Send an alert to OMNIbus, using SNMPTRAP command on z/VM
 - Automatically unhold the message after 4 minutes
- **Dynamically include in the alert**
 - IP address of the z/VM system where the error occurred
 - User ID that received the error message
 - Text of the abend message

Scenario 2b: Detailed Steps

- **View “All Events” in OMNibus**

- **From any VM user ID:**

```
tell esmts105 this user is abending during demo. Send SNMP alert to Netcool
```

- **From an authorized VM user ID, view the console of ESMTS105 (a Linux guest):**

```
gomcmd opmgrml viewcon user(esmts105)
```

- **Issue some Linux commands so the held message moves to the top of the screen**
- **View the OMNibus console to see the alert**
- **After 4 minutes, view the console of ESMTS105 again and notice the held message has moved off the screen**

```
gomcmd opmgrml viewcon user(esmts105)
```

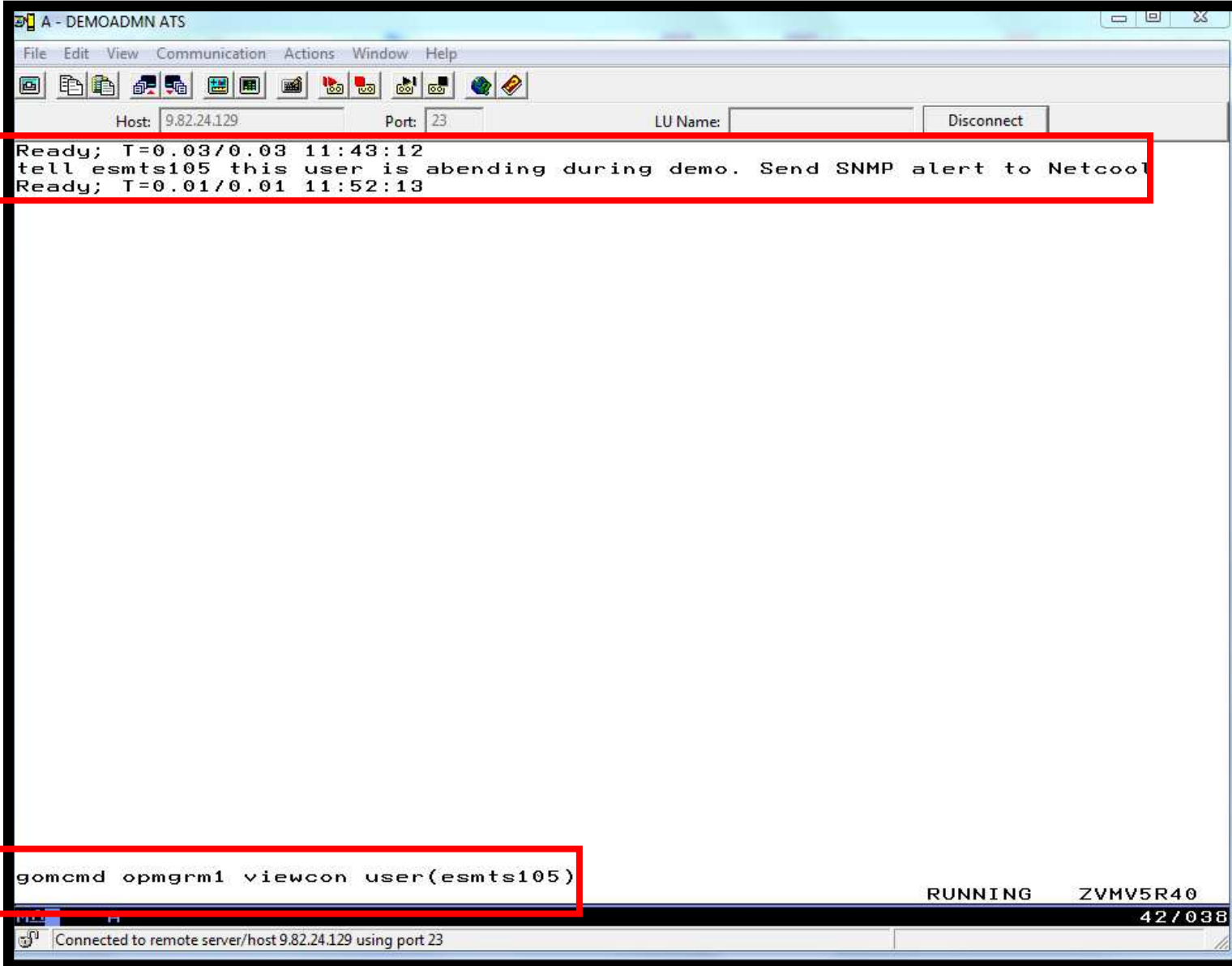

The screenshot shows a terminal window titled "A - DEMOADMN ATS". The window has a menu bar (File, Edit, View, Communication, Actions, Window, Help) and a toolbar. Below the toolbar, there are fields for "Host: 9.82.24.129", "Port: 23", and "LU Name:". A "Disconnect" button is visible on the right. The main area of the terminal displays the following text:

```
Ready; T=0.03/0.03 11:43:12  
tell esmts105 this user is abending during demo. Send SNMP alert to Netcool  
Ready; T=0.01/0.01 11:52:13
```

At the bottom of the terminal, a command prompt shows the command `gomcmd opmgrm1 viewcon user(esmts105)` being entered. To the right of the command, the status "RUNNING" and the identifier "ZVMV5R40" are displayed. Below the command prompt, the text "42 / 038" is visible. At the very bottom of the window, a status bar indicates "Connected to remote server/host 9.82.24.129 using port 23".

```

A - DEMOADMN ATS
File Edit View Communication Actions Window Help
Host: 9.82.24.129 Port: 23 LU Name: Disconnected
11:52:13 * MSG FROM DEMOADMN: this user is abending during demo. Send SNMP ale
11:54:29 tcp 0 0 ::ffff:9.82.56.105:1414 ::ffff:9.76.141.152:49
11:54:29 tcp 0 0 ::ffff:9.82.56.105:1414 ::ffff:9.49.157.148:12
11:54:29 tcp 0 0 ::ffff:9.82.56.105:1414 ::ffff:9.65.203.251:17
11:54:29 tcp 0 0 ::ffff:9.82.56.105:1414 ::ffff:9.65.203.251:17
11:54:30 [root@hasl105 ~]#
11:55:09 * -- Operations Manager VIEWCON session from DEMOADMN entered the foll
11:55:09 netstat -an | grep 50000
11:55:10 netstat -an | grep 50000
11:55:10 tcp 0 0 0.0.0.0:50000 0.0.0.0:*
11:55:10 [root@hasl105 ~]#
11:55:19 * -- Operations Manager VIEWCON session from DEMOADMN entered the foll
11:55:19 netstat -an | grep 9080
11:55:19 netstat -an | grep 9080
11:55:19 tcp 0 0 :::9080 :::*
11:55:19 tcp 0 0 ::ffff:9.82.56.105:9080 ::ffff:9.82.56.119:541
11:55:19 [root@hasl105 ~]#
11:55:25 * -- Operations Manager VIEWCON session from DEMOADMN entered the foll
11:55:25 netstat -an | grep 1414
11:55:25 netstat -an | grep 1414
11:55:25 tcp 0 0 :::1414 :::*
11:55:25 tcp 0 0 ::ffff:9.82.56.105:1414 ::ffff:9.80.8.22:2160
11:55:25 tcp 0 0 ::ffff:9.82.56.105:47497 ::ffff:9.82.56.125:141
11:55:25 tcp 0 0 ::ffff:9.82.56.105:1414 ::ffff:9.76.141.152:49
11:55:25 tcp 0 0 ::ffff:9.82.56.105:1414 ::ffff:9.49.157.148:12
11:55:25 tcp 0 0 ::ffff:9.82.56.105:1414 ::ffff:9.65.203.251:17
11:55:25 tcp 0 0 ::ffff:9.82.56.105:1414 ::ffff:9.65.203.251:17
11:55:25 [root@hasl105 ~]#
11:55:28 * -- Operations Manager VIEWCON session from DEMOADMN entered the foll
11:55:28 netstat -an | grep 50000
11:55:28 netstat -an | grep 50000
11:55:29 tcp 0 0 0.0.0.0:50000 0.0.0.0:*
11:55:29 [root@hasl105 ~]#
11:55:35 * -- Operations Manager VIEWCON session from DEMOADMN entered the foll
11:55:35 netstat -an | grep 9080
11:55:35 netstat -an | grep 9080
11:55:35 tcp 0 0 :::9080 :::*
11:55:35 tcp 0 0 ::ffff:9.82.56.105:9080 ::ffff:9.82.56.119:541
11:55:35 [root@hasl105 ~]#
PF01= SCROLL PF02= EXCMD PF03= END PF04= netsta PF05= HOLD PF06= FORMAT
PF07= UP PF08= DOWN PF09= PF10= LEFT PF11= RIGHT PF12= RECALL
ESMST5105 (Scroll)
MA A 42/001
Connected to remote server/host 9.82.24.129 using port 23
    
```

9.82.38.17 - Remote Desktop Connection

Netcool/OMNIBus Event List : Filter="All Events", View="Default"

File Edit View Alerts Tools Help

All Events Default Top [OFF]

Node	Alert Group	Summary	Last Occurrence	Count	Type
9.82.24.129	Z/VM_SNMP	ESMSTS105; this user is abending during demo. Send SNMP alert to Netcool; ...	4/4/2013 12:52:1...	118	Problem
OPMGR01	SCARY_EVENT	guest_is_abending	3/27/2013 10:28...	51	Problem
has112	PROBLEM_EVENT	Problem has occurred alarm raised	2/2/2012 2:54:02...	2	Problem
DEMOADMIN	SCARY_EVENT	guest_is_abending	1/26/2012 8:16:5...	1	Problem
testuser	SCARY_EVENT	guest_is_abending	1/26/2012 8:15:1...	1	Problem
has104	PROBLEM_EVENT	Problem has occurred	1/23/2012 10:01...	1	Problem
hasle313:LZ	ITM_ControlSignal	Managed system <hasle313:LZ> has switched to new thrunode <REMOTE_ha...	10/14/2011 1:28...	2	ITM Problem
hasle313:LZ	ITM_ControlSignal	Managed system <hasle313:LZ> has switched to new thrunode <REMOTE_ha...	10/14/2011 1:28...	2	ITM Problem
hasle313:KUL	ITM_ControlSignal	Managed system <hasle313:KUL> has switched to new thrunode <REMOTE...	10/14/2011 11:1...	1	ITM Problem
Primary:HASLE...	ITM_ControlSignal	Managed system <Primary:HASLE314:NT> has switched to new thrunode <R...	9/14/2011 10:44...	1	ITM Problem
T42B:CMS	ITM_ManagedSystem	MS_Offline[Status="N" AND Reason<"FA") ON T42B:CMS (Status="*OFFLI...	7/26/2010 12:22...	1	ITM Problem
CICSTG00:MVS...	ITM_ManagedSystem	MS_Offline[Status="N" AND Reason<"FA") ON CICSTG00:MVST:GWIRA (...	7/26/2010 12:22...	1	ITM Problem
Primary:HASLE...	ITM_NT_Process	NT_Process_CPU_Critical[(_Processor_Time)>=65 AND Priority_Base<0...	7/26/2010 12:20...	5	ITM Problem
hasle316	NT Event List@0952...	Attempt to login as root from host hasle316 failed	3/26/2013 9:18:4...	2	Problem
hasle316	Administrator	Attempt to login as administrator from host hasle316 failed	3/10/2013 3:25:3...	1	Problem
hasle316	NT Event List@0952...	Attempt to login as from host hasle316 failed	1/23/2013 10:38...	3	Problem
mwb61	Administrator	Attempt to login as root from host mwb61 failed	10/4/2011 10:11...	2	Problem
hasle316	NT Event List@0952...	Attempt to login as admin from host hasle316 failed	9/8/2011 12:09:3...	1	Problem
9.82.24.129	Generic	Cold Start	6/29/2010 4:06:0...	3	Type Not Set
9.82.24.129	Generic	Authentication	4/15/2012 2:05:4...	1098	Type Not Set
199.8.7.6	Generic	Egp Neighbour Loss	6/25/2010 9:57:2...	1	Type Not Set
hasle316	Windows Event List	A NT Event List@09522611 process running on hasle316 has connected as u...	3/26/2013 9:18:5...	2	Problem
mwb61	Windows Event List	A NT Event List@0941DC5C process running on mwb61 has connected as u...	3/13/2013 4:50:5...	1	Problem
mwb61	Windows Event List	A NT Event List@0941DC5C process running on mwb61 has connected as u...	3/13/2013 4:50:5...	1	Problem
ESMSTS105	WARN_EVENT	fatal_error_on_guest	3/8/2013 4:00:15...	1	Problem
9.82.24.129	Generic	Link Up	3/14/2012 11:13...	1	Type Not Set
Primary:HASLE...	ITM_NT_Event_Log	NT_Service_Error[Source="Service Control Type="Error") ON Primary:HAS...	11/11/2011 12:4...	28	ITM Problem
Primary:HASLE...	ITM_NT_Monitored...	NT_Log_Space_Low[(%_Usage)=95) ON Primary:HASLE314:NT ON Syste...	10/26/2011 12:4...	2	ITM Problem
Primary:HASLE...	ITM_NT_Monitored...	NT_Log_Space_Low[(%_Usage)=95) ON Primary:HASLE340:NT ON Applic...	10/26/2011 12:4...	2	ITM Problem
Primary:HASLE...	ITM_NT_Monitored...	NT_Log_Space_Low[(%_Usage)=95) ON Primary:HASLE340:NT ON Syste...	10/26/2011 12:4...	2	ITM Problem
hasle313:KUL	ITM_Monitored_Logs	UNIX_LAA_Log_Size_Warning[(Log_Size>10485760) ON hasle313:KUL (Log...	10/26/2011 12:4...	1	ITM Problem
hasle313:LZ	ITM_Linux_CPU	Linux_High_CPU_Overload[Idle_CPU<1000 AND CPU_ID=Aggregate) ON h...	10/26/2011 12:4...	1	ITM Problem
hasle313:Z	ITM_Linux_Process	Linux_Process_High_Cpu[Busy_CPU_Pct>60000) ON hasle313:Z ON java (...	10/26/2011 12:4...	1	ITM Problem

0 rows inserted, 1 row updated and 0 rows deleted

4/4/2013 12:57:35 PM root OMNI316 [PRI]

Start Netcool/OMNIBus ... Netcool/OMNIB... 12:57 PM

```

A - DEMOADMN ATS
File Edit View Communication Actions Window Help
Host: 9.82.24.129 Port: 23 LU Name: Disconnect
11:54:30 [root@hasl105 ~]#
11:55:09 * -- Operations Manager VIEWCON session from DEMOADMN entered the foll
11:55:09 netstat -an | grep 50000
11:55:10 netstat -an | grep 50000
11:55:10 tcp 0 0 0.0.0.0:50000 0.0.0.0:*
11:55:10 [root@hasl105 ~]#
11:55:19 * -- Operations Manager VIEWCON session from DEMOADMN entered the foll
11:55:19 netstat -an | grep 9080
11:55:19 netstat -an | grep 9080
11:55:19 tcp 0 0 :::9080 :::*
11:55:19 tcp 0 0 ::ffff:9.82.56.105:9080 ::ffff:9.82.56.119:541
11:55:19 [root@hasl105 ~]#
11:55:25 * -- Operations Manager VIEWCON session from DEMOADMN entered the foll
11:55:25 netstat -an | grep 1414
11:55:25 netstat -an | grep 1414
11:55:25 tcp 0 0 :::1414 :::*
11:55:25 tcp 0 0 ::ffff:9.82.56.105:1414 ::ffff:9.80.8.22:2160
11:55:25 tcp 0 0 ::ffff:9.82.56.105:47497 ::ffff:9.82.56.125:141
11:55:25 tcp 0 0 ::ffff:9.82.56.105:1414 ::ffff:9.76.141.152:49
11:55:25 tcp 0 0 ::ffff:9.82.56.105:1414 ::ffff:9.49.157.148:12
11:55:25 tcp 0 0 ::ffff:9.82.56.105:1414 ::ffff:9.65.203.251:17
11:55:25 tcp 0 0 ::ffff:9.82.56.105:1414 ::ffff:9.65.203.251:17
11:55:25 [root@hasl105 ~]#
11:55:28 * -- Operations Manager VIEWCON session from DEMOADMN entered the foll
11:55:28 netstat -an | grep 50000
11:55:28 netstat -an | grep 50000
11:55:29 tcp 0 0 0.0.0.0:50000 0.0.0.0:*
11:55:29 [root@hasl105 ~]#
11:55:35 * -- Operations Manager VIEWCON session from DEMOADMN entered the foll
11:55:35 netstat -an | grep 9080
11:55:35 netstat -an | grep 9080
11:55:35 tcp 0 0 :::9080 :::*
11:55:35 tcp 0 0 ::ffff:9.82.56.105:9080 ::ffff:9.82.56.119:541
11:55:35 [root@hasl105 ~]#
12:04:38 * -- Operations Manager VIEWCON session from DEMOADMN entered the foll
12:04:38 echo
12:04:39 echo
12:04:39 [root@hasl105 ~]#
PF01= SCROLL PF02= EXCMD PF03= END PF04= netsta PF05= HOLD PF06= FORMAT
PF07= UP PF08= DOWN PF09= PF10= LEFT PF11= RIGHT PF12= RECALL
ESMTS105 (Scroll)
MA A 12:00
Connected to remote server/host 9.82.24.129 using port 23
    
```

Scenario 2b: How Do You Do That?

Rule and actions in Operations Manager:

```
*  
* Send an alert to OMNibus using SNMP for abend msgs on consoles  
DEFRULE NAME(ABNDSNMP),+  
  MATCH(*abend*snmp*),+  
  ACTION(SNMPALRT)  
*  
DEFACTN NAME(SNMPALRT),+  
  COMMAND(EXEC SNMP2OMN &T),+  
  INPUT(CRE,HLD),+  
  ENV(SVM),+  
  NEXTACTN(UNHOLD),+  
  NEXTDELY(03:30)  
*  
DEFACTN NAME(UNHOLD),+  
  COMMAND('ALTRCON USER(ESMTS105),MATCH(*abend*snmp*),ELAPSED(180),HLD(N)'),+  
  ENV(GOM)
```

Scenario 2b: How Did You Do That?

SNMP2OMN EXEC

```
/* SNMP2OMN action routine for Operations Mgr */  
address command  
parse arg ":" msgtext  
msgtext2 = "'msgtext'"  
/* Send message */  
snmptrap trape 1.1 number 30 1.2 text "UXZVM001" 1.3 text msgtext2 ent 1.3.6.1.4.1.9545.6  
exit
```

Scenario 2b: Additional Steps Required on z/VM

- **SNMPD user ID configured and running**
- **Update files on TCPMAINT 198 disk**
 - Add OMNibus IP address to SNMPTRAP DEST file
 - Open SNMPD and SNMPQE ports in PROFILE TCPIP
 - Update SNMPMIBX TEXT section of MIB_EXIT DATA
- **Give OPMGRM1 and OPMGRSn access to SNMPTRAP command**
 - On TCPMAINT 592 disk

Scenario 2b: Additional Steps Required on OMNIbus

- **Install the IBM Tivoli Netcool/OMNIbus SNMP Probe**
 - Install it on same platform as target OMNIbus server
- **Customize operational information in the probe properties (mttrapd.props)**
 - Listening port, heartbeat interval, mibs and mibs locations, etc.
- **Customize the probe rules (mttrapd.rules)**
 - Map variables created by the probe (from data extracted from the SNMP trap) into the desired OMNIbus event fields
 - Default mappings for the SNMP generic traps (trap types 0-5)
 - Enterprise-specific traps (trap type 6) require customization
- **Documentation for installation and customization**
 - IBM Tivoli Netcool/OMNIbus SNMP Probe Reference Guide (SC23-6003-04)

Scenarios 2a and 2b – POSTZMSG vs SNMP

■ Using POSTZMSG

- Can direct the alert to only the IP address(es) you specify
- Need a Linux guest running and logged on that can run POSTZMSG and must be on the same z/VM system
 - Can be overcome by using a socket interface to send POSTZMSG command to the guest
- Limit of 160 characters on POSTZMSG command sent to Linux guest (using CP SEND)
 - Can't always send full text of message
 - Can be overcome by using a socket interface to send POSTZMSG command to the guest

■ Using SNMP

- No requirement for a Linux guest. SNMP runs on z/VM.
- No limit on message size
- All SNMP alerts on z/VM go the same set of IP addresses

Scenario 3a:

Send a Message if Spool Usage is Too High on Any Member in an SSI Cluster

- **Operations Manager monitors the spool usage (percent full) on each member of a cluster**
 - For demo purposes, spool monitor is currently suspended
 - We'll dynamically resume (re-activate) the spool monitor
 - Must reactivate on each member of a cluster
 - Demo monitor requires spool to only be 5% full
- **Usage exceeds the specified limit**
- **Automatically send a message to a central console for the entire cluster**
 - Send a maximum of 3 messages per hour
- **Message includes the member name and % full**
- **For demo purposes, suspend (de-activate) the spool monitors when complete**
- **Demonstrate which spool files are visible on each member**

Scenario 3a: Detailed Steps

- **From an authorized VM user ID, see the spool usage on local member TEST7SSI:**

```
gomcmd opmgrm1 viewspl
```

- **From a user ID with Operations Manager privileges:**

```
gomcmd opmgrm1 resume spool(splfull)
```

```
smsg opmgrm1 at testcssi resume spool(splfull)
```

- **Check the Operations Manager log to see the spool monitor triggered on local member:**

```
gomcmd opmgrm1 viewlog
```

- **View the central console for the cluster to see warning messages from each member:**

```
gomcmd opmgrm1 viewcon user(operssi)
```

- **From a user ID with Operations Manager privileges:**

```
gomcmd opmgrm1 suspend spool(splfull)
```

```
smsg opmgrm1 at testcssi suspend spool(splfull)
```

Scenario 3a: Detailed Steps

- **From member TEST7SSI, send a spool file to a single configuration and a multiconfiguration user:**

```
sendfile test7 file a demoadmn opl
```

- **From member TEST7SSI, send a spool file to a multiconfiguration user on another member:**

```
sendfile testc file a opl at testcssi
```

- **From a user ID with Operations Manager privileges on TEST7SSI, view spool files on TEST7SSI:**

```
gomcmd opmgrm1 viewspl
```

- **From a user ID with Operations Manager privileges on TESTCSSI, view spool files on TESTCSSI:**

```
gomcmd opmgrm1 viewspl
```

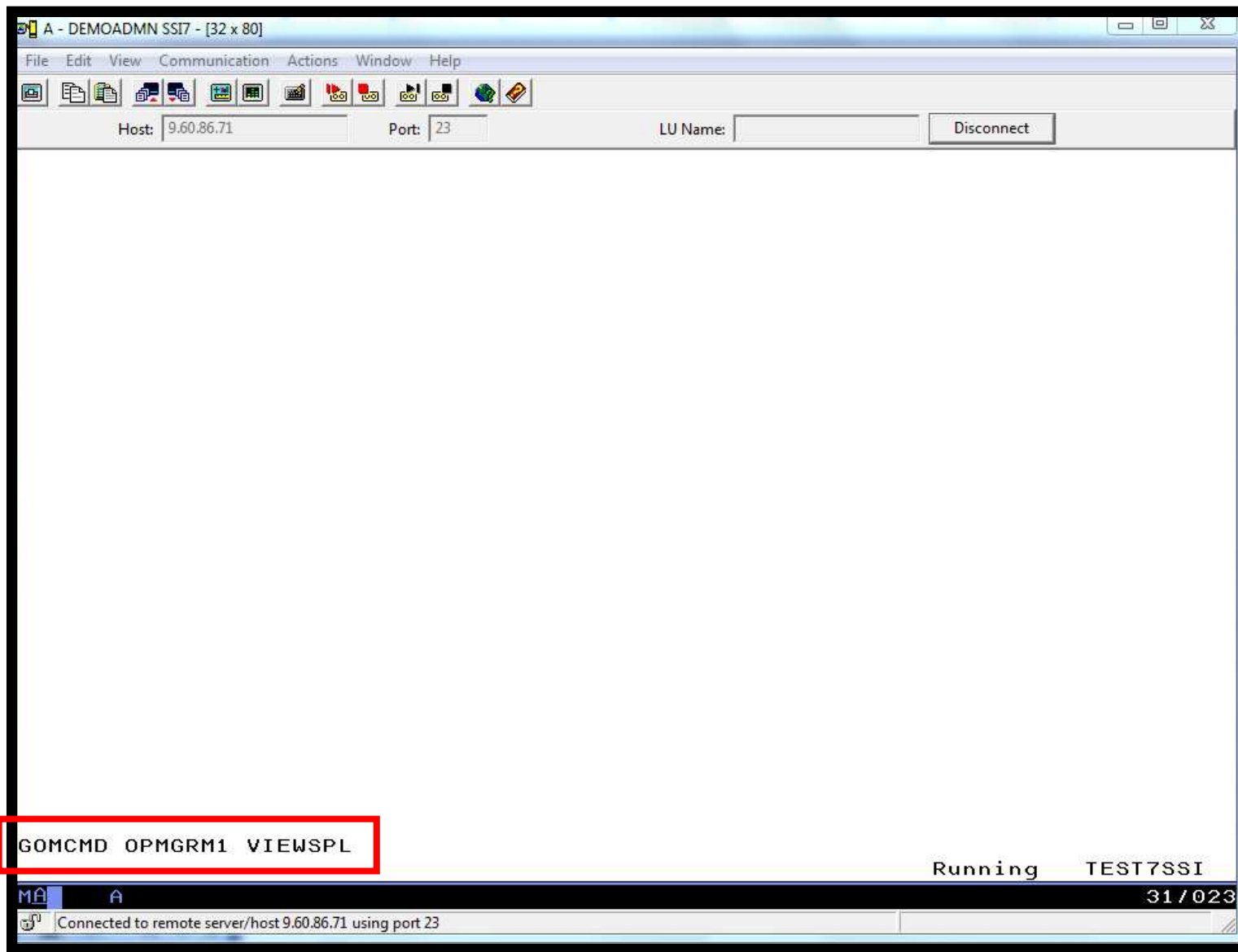

A - DEMOADMN SSI7 - [32 x 80]

File Edit View Communication Actions Window Help

Host: 9.60.86.71 Port: 23 LU Name: Disconnect

System: TEST7SSI Spool: 8% Used Files: 0% Used 1 of 115
 Max: 2.3G Max: 1655640

Cmd	Owner	File	CLS	QUE	TYP	Size	Hold	Date	Time	Name	Type
	DIRMSAT3	0125	0	RDR	PUN	4K	NONE	03/09	16:14:10		
	MAINT620	1325	A	RDR	PUN	8K	NONE	03/09	11:29:59	SLES11C	DIRECT
	OP1	0002	A	RDR	PUN	4K	NONE	03/12	17:26:59	TEST7	FILE
	DIRMSAT3	0121	0	RDR	PUN	4K	NONE	03/07	19:07:03		
	DIRMSAT3	0101	0	RDR	PUN	4K	NONE	03/05	16:05:38		
	DIRMSAT3	0097	0	RDR	PUN	4K	NONE	03/05	15:02:57		
	DIRMSAT3	0093	0	RDR	PUN	4K	NONE	03/05	14:11:56		
	DIRMSAT3	0089	0	RDR	PUN	4K	NONE	03/02	15:13:20		
	DIRMSAT3	0085	0	RDR	PUN	4K	NONE	03/02	13:32:05		
	DEMOADMN	0177	A	RDR	PRT	68K	NONE	10/12	18:40:40	VIEWCON	RHEL6D
	MAINT	0023	A	RDR	PUN	8K	NONE	10/12	15:28:11	RHEL6D	DIRECT
	DIRMSAT3	0117	0	RDR	PUN	4K	NONE	03/06	19:20:38		
	DIRMSAT3	0137	0	RDR	PUN	4K	NONE	03/16	11:11:09		
	DIRMSAT3	0133	0	RDR	PUN	4K	NONE	03/16	10:58:50		
	DIRMSAT3	0113	0	RDR	PUN	4K	NONE	03/06	18:50:38		
	DIRMSAT3	0109	0	RDR	PUN	4K	NONE	03/05	20:50:27		
	DIRMSAT3	0105	0	RDR	PUN	4K	NONE	03/05	18:30:03		
	DIRMSAT3	0081	0	RDR	PUN	4K	NONE	03/01	14:46:16		
	DEMOADMN	0149	R	RDR	PUN	4K	NONE	10/05	13:06:41	TEST	OP1
	DIRMSAT3	0129	0	RDR	PUN	4K	NONE	03/12	14:50:07		
	DEMOADMN	0129	A	RDR	PUN	16K	NONE	10/05	13:00:43	IDSSI711	JOB
	DEMOADMN	0125	A	RDR	PUN	16K	NONE	10/05	13:00:43	IDSSI710	JOB
	DIRMSAT3	0073	0	RDR	PUN	4K	NONE	02/29	21:27:06		
	DIRMSAT3	0069	0	RDR	PUN	4K	NONE	02/29	11:00:00		
	DIRMSAT3	0065	0	RDR	PUN	4K	NONE	02/29	10:39:32		
	DEMOADMN	0217	R	RDR	PUN	4K	NONE	10/16	15:31:26	TEST	OP1

PF01= HELP PF02= VIEW PF03= END PF04= PF05= SORTA PF06= SORTD
 PF07= UP PF08= DOWN PF09= PF10= LEFT PF11= RIGHT PF12=

MA A 05/001

Connected to remote server/host 9.60.86.71 using port 23

```
A - DEMOADMN SSI7 - [32 x 80]
File Edit View Communication Actions Window Help
Host: 9.60.86.71 Port: 23 LU Name: Disconnect
Ready: T=0.0170.01 21:45:04
gomcmd opmgrm1 resume spool(splfull)
Ready: T=0.0170.01 21:45:07
smsg opmgrm1 at testcssi resume spool(splfull)
Ready: T=0.0170.01 21:45:15

gomcmd opmgrm1 viewlog

Running TEST7SSI
31/001
Connected to remote server/host 9.60.86.71 using port 23
```

```

A - DEMOADMN SSI7 - [32 x 80]
File Edit View Communication Actions Window Help
Host: 9.60.86.71 Port: 23 LU Name: Disconnect
03/26/2013 21:45:00 GOMCMD0216L PERFSVM "FCXAPC535I Connected to resource FCX
03/26/2013 21:45:00 GOMCMD0216L IPGATE "IPGATEY0000059147 Request fromPERFSV
03/26/2013 21:45:00 GOMCMD0216L IPGATE "IPGATEY0000059146Thread terminating
03/26/2013 21:45:00 GOMCMD0216L IPGATE "IPGATEY0000059146 ended." VID=*MSG
03/26/2013 21:45:00 GOMCMD0216L IPGATE "IPGATEY0000059147Thread terminating
03/26/2013 21:45:00 GOMCMD0216L PERFSVM "FCXAPC529I Path 000D to FCXRES0D sev
03/26/2013 21:45:00 GOMCMD0216L PERFSVM "FCXAPC536I Path 000D to resource FCX
03/26/2013 21:45:00 GOMCMD0216L IPGATE "IPGATEY0000059147 ended." VID=*MSG
03/26/2013 21:45:07 GOMCMD0201L DEMOADMN "RESUME SPOOL(SPLFULL)" VID=DEMOADMN
03/26/2013 21:45:21 GOMACT0260I SCHEDULE QISLINK ACTION QISLINK TRIGGERED BY
03/26/2013 21:45:21 GOMACT0262I ACTION QISLINK BEGIN FOR _GOMSCHD SERVER OPMG
03/26/2013 21:45:21 GOMACT0269L COMMAND "EXEC QISLINK TESTZSS1 TESTCSST"
03/26/2013 21:45:21 GOMSM00403I SPOOL ALERT: MONITOR SPLFULL USAGE CONDITI
03/26/2013 21:45:21 GOMSM00401I SPOOL USE: MONITOR SPLFULL SPACE 8 PERCENT, F
03/26/2013 21:45:21 GOMSM00402I SPOOL CHG: MONITOR SPLFULL SPACE 0 PERCENT, F
03/26/2013 21:45:21 GOMACT0260I SPOOL SPLFULL ACTION SPLPAGE TRIGGERED BY _G
03/26/2013 21:45:21 GOMACT0262I ACTION SPLPAGE BEGIN FOR _GOMSMON SERVER OPMG
03/26/2013 21:45:21 GOMACT0269L COMMAND "EXEC MSG20PER JUNK JUNK SPOOL 8 USAGE
03/26/2013 21:45:21 GOMACT0270L 1 * * Address Command
03/26/2013 21:45:21 GOMACT0270L 5 *-* Parse arg userid euser event source
03/26/2013 21:45:21 GOMACT0270L >>> "JUNK"
03/26/2013 21:45:21 GOMACT0270L >>> "JUNK"
03/26/2013 21:45:21 GOMACT0270L >>> "SPOOL"
03/26/2013 21:45:21 GOMACT0270L >>> "8"
03/26/2013 21:45:21 GOMACT0270L >>> "USAGE"
03/26/2013 21:45:21 GOMACT0270L 7 *-* 'GOMGLBL INTO sysname NAME tcphostn
03/26/2013 21:45:21 GOMACT0270L >>> "GOMGLBL INTO sysname NAME tcphos
03/26/2013 21:45:21 GOMACT0270L 9 *-* if userid = '_GOMEMON'
PF01= SCROLL PF02= PF03= END PF04= PF05= HOLD PF06=
PF07= UP PF08= DOWN PF09= PF10= LEFT PF11= RIGHT PF12= RECALL
_GOMALOG
MA A 31/001
Connected to remote server/host 9.60.86.71 using port 23

```

```

A - DEMOADMN SSI7 - [32 x 80]
File Edit View Communication Actions Window Help
Host: 9.60.86.71 Port: 23 LU Name: Disconnect
00:00:00 HCPMID6001I TIME IS 00:00:00 EDT SATURDAY 03/16/13
00:00:00
00:00:00 HCPMID6001I TIME IS 00:00:00 EDT SUNDAY 03/17/13
00:00:00
00:00:00 HCPMID6001I TIME IS 00:00:00 EDT MONDAY 03/18/13
00:00:00
00:00:00 HCPMID6001I TIME IS 00:00:00 EDT TUESDAY 03/19/13
00:00:00
00:00:00 HCPMID6001I TIME IS 00:00:00 EDT WEDNESDAY 03/20/13
00:00:00
00:00:00 HCPMID6001I TIME IS 00:00:00 EDT THURSDAY 03/21/13
00:00:00
00:00:00 HCPMID6001I TIME IS 00:00:00 EDT FRIDAY 03/22/13
00:00:00
00:00:00 HCPMID6001I TIME IS 00:00:00 EDT SATURDAY 03/23/13
00:00:00
00:00:00 HCPMID6001I TIME IS 00:00:00 EDT SUNDAY 03/24/13
00:00:00
00:00:00 HCPMID6001I TIME IS 00:00:00 EDT MONDAY 03/25/13
00:00:00
00:00:00 HCPMID6001I TIME IS 00:00:00 EDT TUESDAY 03/26/13
00:00:00
21:45:21 Spool is 8% full on TEST7SSI
21:46:09 Spool is 7% full on TESTCSSI
21:46:21 Spool is 8% full on TEST7SSI
21:47:09 Spool is 7% full on TESTCSSI
21:47:21 Spool is 8% full on TEST7SSI
21:48:09 Spool is 7% full on TESTCSSI
PF01= SCROLL PF02= PF03= END PF04= PF05= HOLD PF06= FORMAT
PF07= UP PF08= DOWN PF09= PF10= LEFT PF11= RIGHT PF12= RECALL
OPERSSI (Scroll)
MA A 31/001
Connected to remote server/host 9.60.86.71 using port 23
    
```

```
A - DEMOADMN SSI7 - [32 x 80]
File Edit View Communication Actions Window Help
Host: 9.60.86.71 Port: 23 LU Name: Disconnect
Ready; I=0.0170.01 21:52:11
gomcmd opmgrm1 suspend spool(splfull)
Ready; I=0.0170.01 21:52:31
smsg opmgrm1 at testcssi suspend spool(splfull)
Ready; I=0.0170.01 21:52:37
sendfile test7 file a demoadm op1
File TEST7 FILE A1 sent to DEMOADMN at TEST7SSI on 03/26/13 21:52:49
File TEST7 FILE A1 sent to OP1 at TEST7SSI on 03/26/13 21:52:49
2 files have been sent
Ready; I=0.0170.01 21:52:49
sendfile testc file a op1 at testcssi
File TESTC FILE A1 sent to OP1 at TESTCSSI on 03/26/13 21:53:00
Ready; I=0.0170.01 21:53:00
From TESTCSSI: DMTAXM104I File (0184) spooled to OP1 -- origin TEST7SSI(DEMOADMN) 03/26/13 21:52:59 EDT

gomcmd opmgrm1 viewspl

Running TEST7SSI
```

MA A 01/001

Connected to remote server/host 9.60.86.71 using port 23

A - DEMOADMN SSI7 - [32 x 80]

File Edit View Communication Actions Window Help

Host: 9.60.86.71 Port: 23 LU Name: Disconnect

System: TEST7SSI Spool: 8% Used Files: 0% Used 1 of 117
 Max: 2.3G Max: 1655640

Cmd	Owner	File	CLS	QUE	TYP	Size	Hold	Date	Time	Name	Type
	OP1	0003	A	RDR	PUN	4K	NONE	03/26	21:52:49	TEST7	FILE
	DEMOADMN	0265	A	RDR	PUN	4K	NONE	03/26	21:52:49	TEST7	FILE
	MAINT	0000	T	RDR	CON	4K	NONE	03/26	07:11:08		
	OPMGRS3	*0275	T	PRT	CON	4K	NONE	03/26	00:50:13		
	DISKACNT	*0129	T	PRT	CON	4K	NONE	03/26	00:15:00		
	DIRMAINT	*0669	T	PRT	CON	136K	NONE	03/26	00:01:03		
	DATAMOVE	*0525	T	PRT	CON	132K	NONE	03/26	00:01:03		
	RACFSMF	0080	A	RDR	PUN	4K	NONE	03/25	00:20:03	\$SMF\$	ARCHIVE
	LOGS	*9397	T	PRT	CON	96K	NONE	03/15	13:40:29		
	MAINT620	2733	A	RDR	PUN	136K	NONE	03/13	12:58:55	S1705546	SERVLINK
	FTPSEVE	*0058	T	PRT	CON	4K	NONE	03/13	00:00:00		
	OPMGRS2	*0061	T	PRT	CON	4K	NONE	03/12	09:08:04		
	RSCS	*0145	T	PRT	CON	20K	NONE	03/12	09:01:54		
	PVM	*0058	T	PRT	CON	12K	NONE	03/12	00:01:27		
	MONGRID	*0237	T	PRT	CON	4K	NONE	03/12	00:01:27		
	PERFSVM	*0115	T	PRT	CON	28K	NONE	03/12	00:01:27		
	VMSEVR	*0058	T	PRT	CON	4K	NONE	03/12	00:01:27		
	TCPIP	*0058	T	PRT	CON	28K	NONE	03/12	00:01:27		
	ATSSERV	*0229	T	PRT	CON	16K	NONE	03/12	00:01:27		
	SMTP	*0070	T	PRT	CON	4K	NONE	03/12	00:01:27		
	OPMGRS1	*0175	T	PRT	CON	12K	NONE	03/12	00:01:27		
	BKRCATLG	*0171	T	PRT	CON	324K	NONE	03/12	00:01:27		
	BKRBKUP	*0064	T	PRT	CON	344K	NONE	03/12	00:01:27		
	DTCVSW2	*0058	T	PRT	CON	4K	NONE	03/12	00:01:27		
	IPGATE	*0229	T	PRT	CON	912K	NONE	03/12	00:01:27		
	TOOLS	*0545	T	PRT	CON	36K	NONE	03/12	00:01:27		

PF01= HELP PF02= VIEW PF03= END PF04= PF05= SORTA PF06= SORTD
 PF07= UP PF08= DOWN PF09= PF10= LEFT PF11= RIGHT PF12=

MA A 05/001

Connected to remote server/host 9.60.86.71 using port 23

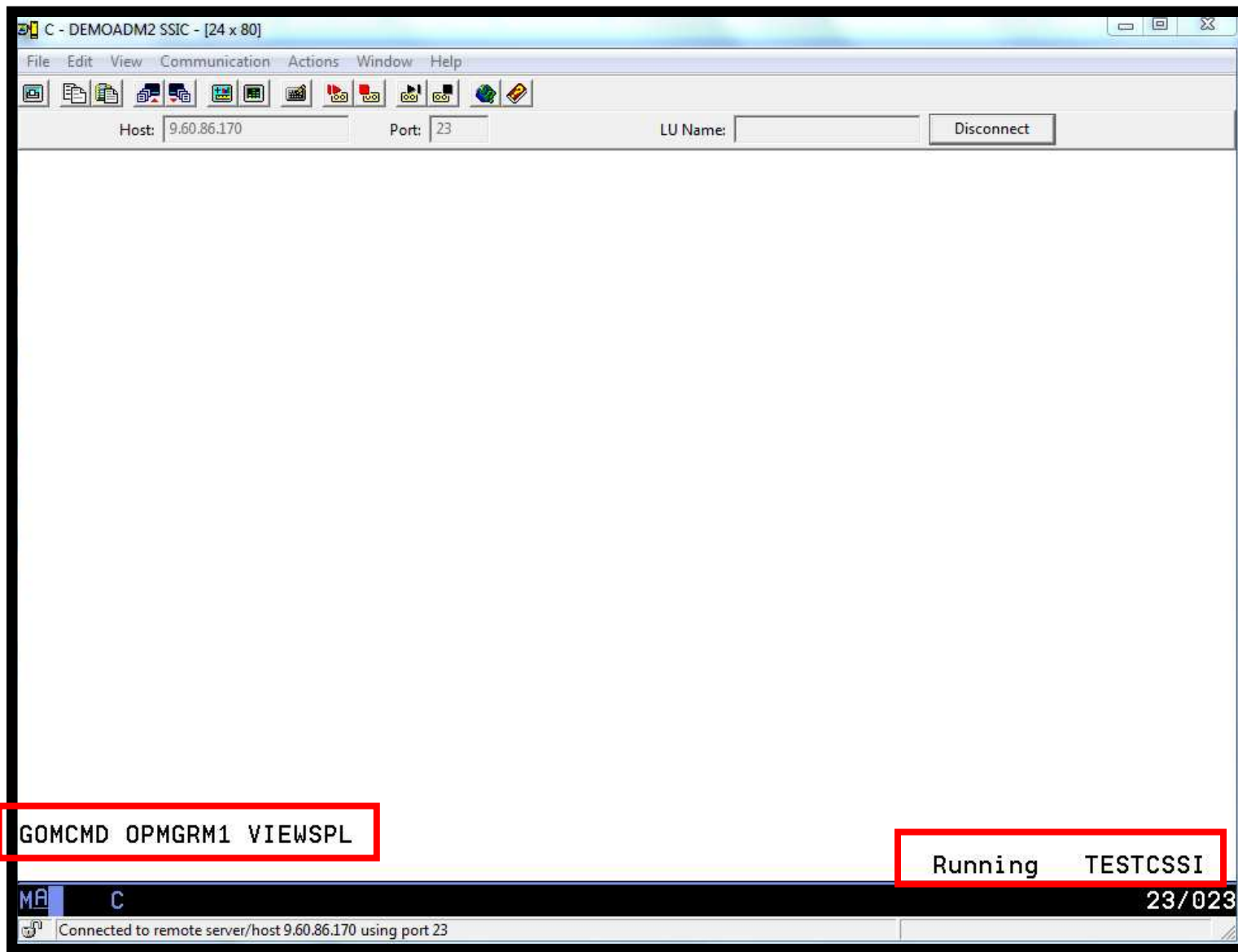

C - DEMOADM2 SSIC - [24 x 80]

File Edit View Communication Actions Window Help

Host: 9.60.86.170 Port: 23 LU Name: Disconnect

System: TESTCSSI Spool: 7% Used Files: 0% Used 1 of 36
 Max: 2.3G Max: 1655640

Cmd	Owner	File	CLS	QUE	TYP	Size	Hold	Date	Time	Name	Type
	OP1	0003	A	RDR	PUN	4K	NONE	03/26	21:53:01	TESTC	FILE
	OPMGRS4	*0288	T	PRT	CON	4K	NONE	03/26	00:50:02		
	DISKACNT	*0130	T	PRT	CON	4K	NONE	03/26	00:15:00		
	DIRMSAT2	*0602	T	PRT	CON	108K	NONE	03/26	00:01:02		
	DATAMOV2	*0534	T	PRT	CON	136K	NONE	03/26	00:01:02		
	RACFSMF	0029	A	RDR	PUN	4K	NONE	03/25	00:20:25	\$SMF\$	ARCHIVE
	OPERATOR	*0062	T	PRT	CON	24K	NONE	03/15	13:42:29		
	OPMGRS3	*0013	T	PRT	CON	4K	NONE	03/13	00:00:00		
	FTPSEVE	*0013	T	PRT	CON	4K	NONE	03/13	00:00:00		
	RSCS	*0013	T	PRT	CON	8K	NONE	03/13	00:00:00		
	VMSEVR	*0061	T	PRT	CON	4K	NONE	03/12	00:01:21		
	PERFSVM	*0118	T	PRT	CON	28K	NONE	03/12	00:01:21		
	BKRCATLG	*0061	T	PRT	CON	324K	NONE	03/12	00:01:21		
	TCPIP	*0061	T	PRT	CON	8K	NONE	03/12	00:01:21		
	PVM	*0061	T	PRT	CON	8K	NONE	03/12	00:01:21		
	BKRBKUP	*0061	T	PRT	CON	336K	NONE	03/12	00:01:21		
	SMTP	*0079	T	PRT	CON	4K	NONE	03/12	00:01:21		
	DTCVSW2	*0061	T	PRT	CON	4K	NONE	03/12	00:01:21		

PF01= HELP PF02= VIEW PF03= END PF04= PF05= SORTA PF06= SORTD
 PF07= UP PF08= DOWN PF09= PF10= LEFT PF11= RIGHT PF12=

MA C 05/001

Connected to remote server/host 9.60.86.170 using port 23

Scenario 3a: How Do You Do That?

Rule and action in Operations Manager:

```
*  
* Send an alert to OPERSSI console if spool too full  
DEFMON NAME(SPLFULL),+  
  USAGE(005-100),+  
  INTERVAL(1),+  
  LIMIT(3,3600),+  
  ACTION(SPLPAGE)  
*  
DEFACTN NAME(SPLPAGE),+  
  COMMAND(EXEC MSG2OPER junk junk &0 &4 &3),+  
  ENV(LVM)  
*  
SUSPEND SPOOL(SPLFULL)
```

Scenario 3a: How Do You Do That?

MSG2OPER EXEC

Address Command

Parse arg userid euser event sourcesys msgtext

```
'GOMGLBL INTO sysname NAME tcphostname'
```

```
if userid = '_GOMEMON' then
```

```
  do
```

```
    if event = 9 then
```

```
      msgtext = 'Outbound relocation for' euser 'on' sourcesys 'started'
```

```
    else
```

```
      msgtext = 'Inbound relocation for' euser 'on' sourcesys 'started'
```

```
      'CP MSGNOH OPERSSI AT ALL From' sysname ':' msgtext
```

```
    end
```

```
  else
```

```
    if event = 'SPOOL' then
```

```
      'CP MSGNOH OPERSSI AT ALL Spool is' sourcesys'% full on' sysname
```

```
    else
```

```
      if event = 'PAGE' then
```

```
        'CP MSGNOH OPERSSI AT ALL Page space is' sourcesys'% full on' sysname
```

```
      else
```

```
        'CP MSGNOH OPERSSI AT ALL From' userid 'on' sysname ':' msgtext
```

```
Exit rc
```

Scenario 3b: Send an Email if Spool Usage is Too High

- **Operations Manager monitors the spool usage (percent full)**
 - For demo purposes, spool monitor is currently suspended
 - We'll dynamically resume (re-activate) the spool monitor
 - Demo monitor requires spool to only be 25% full or higher
- **Usage exceeds the specified limit**
- **Automatically send an e-mail to someone who can evaluate and take action**
- **For demo purposes, suspend (de-activate) the spool monitor when complete**

Scenario 3b: Detailed Steps

- **From an authorized VM user ID, see the spool usage:**

```
gomcmd opmgrm1 viewspl
```

- **From a user ID with Operations Manager privileges:**

```
gomcmd opmgrm1 resume spool(splfull)
```

- **Check the Operations Manager log to see the spool monitor triggered:**

```
gomcmd opmgrm1 viewlog
```

- **Check the inbox of the appropriate person to see the e-mail**

- **From a user ID with Operations Manager privileges:**

```
gomcmd opmgrm1 suspend spool(splfull)
```

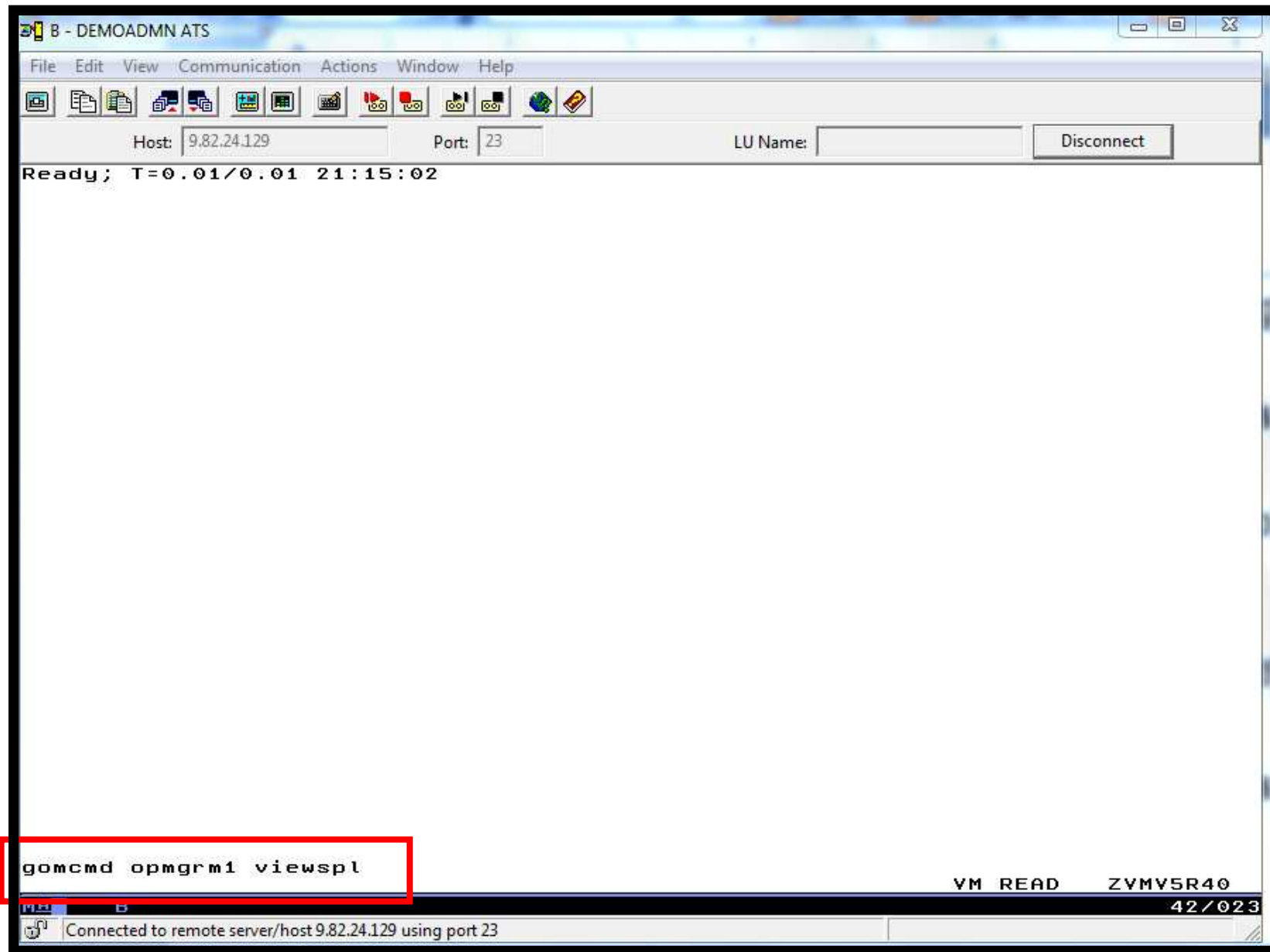

B - DEMOADMN ATS

File Edit View Communication Actions Window Help

Host: 9.82.24.129 Port: 23 LU Name: Disconnect

System: ZVMV5R40 **Spool: 43% Used** Files: 0% Used 1 of 609
 Max: 2.3G Max: 1655640

Cmd	Owner	File	CLS	QUE	TYP	Size	Hold	Date	Time	Name	Type
	AMVADMIN	0010	T	RDR	CON	428K	NONE	11/08	13:20:08		
	AMVARKIV	*0014	T	PRT	CON	2M	NONE	11/30	19:10:00		
	ATS01	*0018	A	PRT	CON	44K	NONE	08/06	15:27:00		
	BKRADMIN	0091	T	RDR	CON	1M	NONE	02/29	20:04:03		
	BKRADMIN	0090	T	RDR	CON	1M	NONE	02/29	20:03:59		
	BKRADMIN	0087	T	RDR	CON	4K	NONE	12/14	17:27:39	WORKER	OUTPUT
	BKRADMIN	0086	T	RDR	CON	12K	NONE	12/14	17:27:38	SINEDISK	20111214
	BKRADMIN	0088	T	RDR	CON	2M	NONE	12/14	15:53:50		
	BKRADMIN	0084	T	RDR	CON	8K	NONE	12/14	15:27:28		
	BKRADMIN	0005	T	RDR	CON	4K	NONE	05/10	11:16:57	WORKER	OUTPUT
	BKRADMIN	0004	T	RDR	CON	8K	NONE	05/10	11:16:56	SAMPLE	20100510
	BKRADMIN	0081	T	RDR	CON	4K	NONE	05/10	03:05:15	WORKER	OUTPUT
	BKRADMIN	0079	T	RDR	CON	12K	NONE	05/10	03:05:15	SAMPLE	20110510
	BKRADMIN	0080	T	RDR	CON	4K	NONE	05/10	03:04:20	WORKER	OUTPUT
	BKRADMIN	0078	T	RDR	CON	4K	NONE	05/10	03:02:33	WORKER	OUTPUT
	BKRADMIN	0076	T	RDR	CON	12K	NONE	05/10	03:02:33	SAMPLE	20110510
	BKRADMIN	0077	T	RDR	CON	8K	NONE	05/10	03:02:26	SAMPLE	20110510
	BKRADMIN	0075	T	RDR	CON	4K	NONE	05/10	03:00:13	WORKER	OUTPUT
	BKRADMIN	0074	T	RDR	CON	12K	NONE	05/10	03:00:13	SAMPLE	20110510
	BKRADMIN	0073	T	RDR	CON	4K	NONE	05/10	02:56:48	WORKER	OUTPUT
	BKRADMIN	0069	T	RDR	CON	12K	NONE	05/10	02:56:48	SAMPLE	20110510
	BKRADMIN	0072	T	RDR	CON	4K	NONE	05/10	02:55:33	WORKER	OUTPUT
	BKRADMIN	0071	R	RDR	CON	4K	NONE	05/10	02:55:25	WORKER	OUTPUT
	BKRADMIN	0070	T	RDR	CON	4K	NONE	05/10	02:53:54	WORKER	OUTPUT
	BKRADMIN	0066	T	RDR	CON	12K	NONE	05/10	02:53:54	SAMPLE	20110510
	BKRADMIN	0068	T	RDR	CON	8K	NONE	05/10	02:53:42	ATS14	20110510
	BKRADMIN	0065	T	RDR	CON	12K	NONE	05/10	02:53:42	ATS05	20110510
	BKRADMIN	0067	T	RDR	CON	12K	NONE	05/10	02:53:22	ATS14	20110510
	BKRADMIN	0064	R	RDR	CON	4K	NONE	05/10	02:51:26	WORKER	OUTPUT
	BKRADMIN	0063	T	RDR	CON	4K	NONE	05/10	02:51:24	WORKER	OUTPUT
	BKRADMIN	0062	T	RDR	CON	12K	NONE	05/10	02:51:23	SAMPLE	20110510
	BKRADMIN	0061	T	RDR	CON	12K	NONE	05/10	02:49:07	ATS14	20110510
	BKRADMIN	0060	R	RDR	CON	4K	NONE	05/10	02:48:11	WORKER	OUTPUT
	BKRADMIN	0059	A	RDR	PUN	4K	NONE	05/10	02:48:11	RESTORE	FAILURE
	BKRADMIN	0058	R	RDR	CON	4K	NONE	05/10	02:44:33	WORKER	OUTPUT
	BKRADMIN	0056	A	RDR	PUN	4K	NONE	05/10	02:44:33	RESTORE	FAILURE
	BKRADMIN	0057	R	RDR	CON	4K	NONE	05/10	02:43:46	WORKER	OUTPUT

PF01= HELP PF02= VIEW PF03= END PF04= PF05= SORTA PF06= SORTD
 PF07= UP PF08= DOWN PF09= PF10= LEFT PF11= RIGHT PF12=

MA B 05/001

Connected to remote server/host 9.82.24.129 using port 23

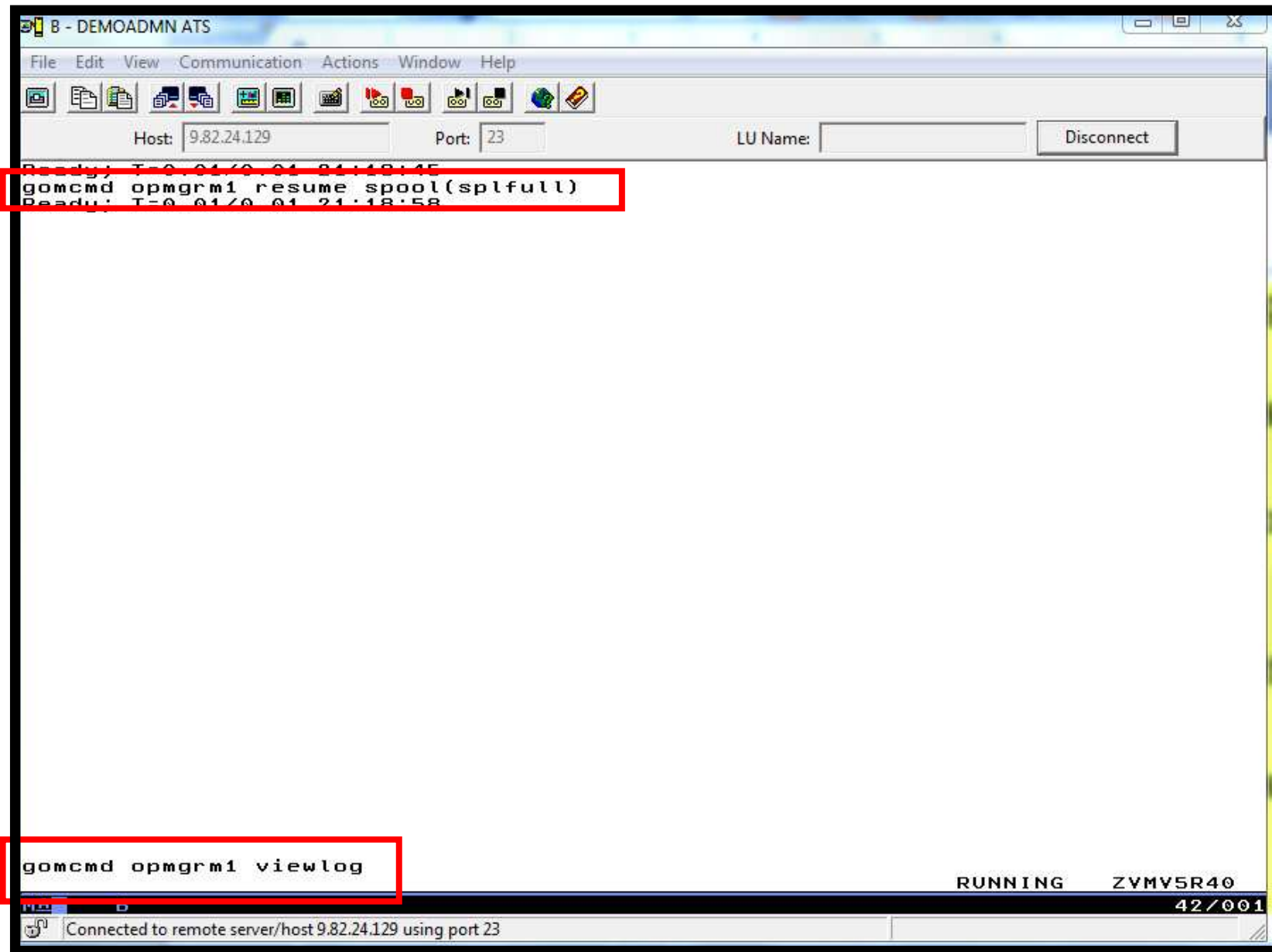

```

B - DEMOADMN ATS
File Edit View Communication Actions Window Help
Host: 9.82.24.129 Port: 23 LU Name: Disconnect
03/26/2013 21:12:14 GOMCMD0216L BKRBAKUP "BKRBAK8510I 03/26/13 21:12:14 WAKEUP
03/26/2013 21:12:14 GOMCMD0216L BKRBAKUP "BKRBAK8512I The stack contains 0 ent
03/26/2013 21:17:17 GOMCMD0216L AMVARKIV " " VID=*MSG SRC=MASIUCV CLS=8
03/26/2013 21:17:17 GOMCMD0216L AMVARKIV "03/26/13 21:17:17 WAKEUP exited on a
03/26/2013 21:17:17 GOMCMD0216L AMVARKIV "The stack contains 0 lines. There ar
03/26/2013 21:17:26 GOMCMD0201L DEMOADMN "VIEWSPL" VID=DEMOADMN SRC=MASIUCV C
03/26/2013 21:18:58 GOMCMD0201L DEMOADMN "RESUME SPOOL(SPLFULL)" VID=DEMOADMN
03/26/2013 21:19:02 GOMSM00403I SPOOL ALERT: MONITOR SPLFULL USAGE CONDITI
03/26/2013 21:19:02 GOMSM00401I SPOOL USE: MONITOR SPLFULL SPACE 43 PERCENT,
03/26/2013 21:19:02 GOMSM00402I SPOOL CHG: MONITOR SPLFULL SPACE 0 PERCENT, F
03/26/2013 21:19:02 GOMACT0260I SPOOL SPLFULL ACTION SPMEMAIL TRIGGERED BY _G
03/26/2013 21:19:02 GOMACT0262I ACTION SPMEMAIL BEGIN FOR _GOMSMON SERVER OPMG
03/26/2013 21:19:02 GOMACT0269L COMMAND "EXEC SMTPSPL TLD1 AT US.IBM.COM 43"
03/26/2013 21:19:02 GOMCMD0201L OPMGRM1 "STATUS DETAIL(SPOOLUSR) " VID=OPMGRM
03/26/2013 21:19:02 GOMCMD0970I USER PERFSVM SPOOL FILE ID 1293 IS USING 2128
03/26/2013 21:19:02 GOMCMD0970I USER PERFSVM SPOOL FILE ID 1295 IS USING 2128
03/26/2013 21:19:02 GOMCMD0970I USER PERFSVM SPOOL FILE ID 1296 IS USING 2128
03/26/2013 21:19:02 GOMCMD0970I USER PERFSVM SPOOL FILE ID 1297 IS USING 2128
03/26/2013 21:19:02 GOMCMD0970I USER PERFSVM SPOOL FILE ID 1275 IS USING 2127
03/26/2013 21:19:02 GOMCMD0970I USER PERFSVM SPOOL FILE ID 1276 IS USING 2127
03/26/2013 21:19:02 GOMCMD0970I USER PERFSVM SPOOL FILE ID 1277 IS USING 2127
03/26/2013 21:19:02 GOMCMD0970I USER PERFSVM SPOOL FILE ID 1278 IS USING 2127
03/26/2013 21:19:02 GOMCMD0970I USER PERFSVM SPOOL FILE ID 1279 IS USING 2127
03/26/2013 21:19:02 GOMCMD0970I USER PERFSVM SPOOL FILE ID 1280 IS USING 2127
03/26/2013 21:19:02 GOMCMD0971I USER LISTGEN HAS 174 SPOOL FILES USING 174 SP
03/26/2013 21:19:02 GOMCMD0971I USER MAINT HAS 97 SPOOL FILES USING 380 SPO
03/26/2013 21:19:02 GOMCMD0971I USER BKRADMIN HAS 87 SPOOL FILES USING 2666 SP
03/26/2013 21:19:02 GOMCMD0971I USER OPMGRM1 HAS 49 SPOOL FILES USING 126 SPO
03/26/2013 21:19:02 GOMCMD0971I USER PERFSVM HAS 43 SPOOL FILES USING 91465 S
03/26/2013 21:19:02 GOMCMD0971I USER OPERATOR HAS 24 SPOOL FILES USING 467 SPO
03/26/2013 21:19:02 GOMCMD0971I USER HARRISJO HAS 15 SPOOL FILES USING 21 SPOO
03/26/2013 21:19:02 GOMCMD0971I USER TCPMAINT HAS 13 SPOOL FILES USING 158 SPO
03/26/2013 21:19:02 GOMCMD0971I USER DEMOADMN HAS 10 SPOOL FILES USING 11 SPOO
03/26/2013 21:19:02 GOMCMD0971I USER SINE HAS 6 SPOOL FILES USING 540 SPOO
03/26/2013 21:19:02 GOMCMD2999I STATUS DETAIL COMPLETE
03/26/2013 21:19:02 GOMACT0270L DMSXSU587I XEDIT:
03/26/2013 21:19:02 GOMACT0270L NOTE OPMGRM1 NOTE A1 sent to TLD1 at US.IBM.CO
03/26/2013 21:19:02 GOMACT0267I ACTION SPMEMAIL END RC=0 SERVER OPMGRM1
03/26/2013 21:19:02 GOMACT0260I SPOOL SPLFULL ACTION SPMEMAIL2 TRIGGERED BY _G
PF01= SCROLL PF02= PF03= END PF04= PF05= HOLD PF06=
PF07= UP PF08= DOWN PF09= PF10= LEFT PF11= RIGHT PF12= RECALL
_GOMALOG
42/001
Connected to remote server/host 9.82.24.129 using port 23
    
```

IBM Confidential, Important. 2013 Field AI AX (FY08) Projections 12/19/2012 12:25 PM 120K

Normal

OPMGRM1	Spool is 43% full on z/VM system on GDP4.GDPSPLEX.WSCLAB.WASHINGTON	03/26/2013 07:21 PM	4K
OPMGRM1	Spool is 43% full on z/VM system on GDP4.GDPSPLEX.WSCLAB.WASHINGTON	03/26/2013 07:20 PM	4K
OPMGRM1	Spool is 43% full on z/VM system on GDP4.GDPSPLEX.WSCLAB.WASHINGTON	03/26/2013 07:19 PM	4K

New Reply Reply to All Forward Display More

Spool is 43% full on z/VM system on GDP4.GDPSPLEX.WSCLAB.WASHINGTON.IBM.COM 03/26/2013 07:21 PM
 OPMGRM1 to: Tracy Dean [Show Details](#)
 Default custom expiration date: 03/26/2014

DO NOT REPLY - This e-mail was generated by an automated service machine

Spool is 43% full on z/VM system on GDP4.GDPSPLEX.WSCLAB.WASHINGTON.IBM.COM

Following are the top ten largest spool files and the top ten users with the most spool files.

```

=====
USER PERFSVM SPOOL FILE ID 1293 IS USING 2128 SPOOL BLOCKS
USER PERFSVM SPOOL FILE ID 1295 IS USING 2128 SPOOL BLOCKS
USER PERFSVM SPOOL FILE ID 1296 IS USING 2128 SPOOL BLOCKS
USER PERFSVM SPOOL FILE ID 1297 IS USING 2128 SPOOL BLOCKS
USER PERFSVM SPOOL FILE ID 1275 IS USING 2127 SPOOL BLOCKS
USER PERFSVM SPOOL FILE ID 1276 IS USING 2127 SPOOL BLOCKS
USER PERFSVM SPOOL FILE ID 1277 IS USING 2127 SPOOL BLOCKS
USER PERFSVM SPOOL FILE ID 1278 IS USING 2127 SPOOL BLOCKS
USER PERFSVM SPOOL FILE ID 1279 IS USING 2127 SPOOL BLOCKS
USER PERFSVM SPOOL FILE ID 1280 IS USING 2127 SPOOL BLOCKS
USER LISTGEN HAS 174 SPOOL FILES USING 174 SPOOL BLOCKS
USER MAINT HAS 97 SPOOL FILES USING 380 SPOOL BLOCKS
USER BKRADMIN HAS 87 SPOOL FILES USING 2666 SPOOL BLOCKS
USER OPMGRM1 HAS 51 SPOOL FILES USING 132 SPOOL BLOCKS
USER PERFSVM HAS 43 SPOOL FILES USING 91465 SPOOL BLOCKS
USER OPERATOR HAS 24 SPOOL FILES USING 467 SPOOL BLOCKS
USER HARRISJO HAS 15 SPOOL FILES USING 21 SPOOL BLOCKS
USER TCPMAINT HAS 13 SPOOL FILES USING 158 SPOOL BLOCKS
USER DEMOADMIN HAS 10 SPOOL FILES USING 11 SPOOL BLOCKS
USER SINE HAS 6 SPOOL FILES USING 540 SPOOL BLOCKS
    
```

Scenario 3b: How Do You Do That?

Spool monitor and action in Operations Manager:

*

*

```
DEFSMON NAME(SPLFULL),+
```

```
  USAGE(025-100),+
```

```
  INTERVAL(1),+
```

```
  LIMIT(3,3600),_
```

```
  ACTION(SPLEMAIL)
```

*

```
DEFACTN NAME(SPLEMAIL),+
```

```
  COMMAND(EXEC SMTPSPL tld1 at us.ibm.com &4),+
```

```
  ENV(LVM)
```

Scenario 3b: How Do You Do That?

SMTSPSPL EXEC (excerpts)

```
/* */
Parse arg mail_user dummyat mail_node spoolpct

errtext = 'Spool is' spoolpct'% full on z/VM system'

/* Get TCP hostname and domain from Ops Mgr global variables */
...
line.1 = 'OPTIONS: NOACK    LOG    SHORT    NONOTEBOOK ALL CLASS A'
line.2 = 'Date: ' Date() ', ' Time()
...
line.8 = errtext 'on' fqdomain_name
line.9 = ' '
line.10 = 'Following are the top ten largest spool files and the top ten u
ith the most spool files.'
line.11 = '===== '
line.0 = 11
'PIPE stem line. | > TEMP NOTE A'
'PIPE command GOMCMD OPMGRM1 STATUS DETAIL(SPOOLUSR) | specs words 4-* 1 |
spooldata.'
spooldata.0 = 20
'PIPE stem spooldata. | >> TEMP NOTE A'
'EXEC SENDFILE TEMP NOTE A (NOTE SMTP'
```

Scenario 4: Find and View Spool Files – Clean up the Spool

- **Authorized user specifies spool search criteria**
 - By user ID
 - By date
 - By file size
- **Result list presented**
 - Sort
 - Open/view a specific spool file
 - Purge, modify metadata, or transfer a file

Scenario 4: Detailed Steps

- **From an authorized VM user ID, view the spool files:**

```
gomcmd opmgrml viewspl
```

- **Sort by date**

- Put cursor on date column header and hit F6

- **Find the spool files just sent and type PURGE next to them**

- **From an authorized VM user ID, view the log to see that the spool monitor is no longer triggered:**

```
gomcmd opmgrml viewlog
```

A - ATS Demo

File Edit View Communication Actions Window Help

System: ZVMV5R20 Spool: 85% Used Files: 0% Used 1 of 1075
 Max: 4.8G Max: 1655640

Cmd	Owner	File	CLS	QUE	TYP	Size	Hold	Date	Time	Name	Type
OPERATNS	0008	D	RDR	DMP		379M	NONE	10/12	16:58:40	CPDUMP	CPDUMP
OPERATNS	0010	D	RDR	DMP		511M	NONE	05/20	21:04:24	CPDUMP	CPDUMP
PERFSVM	0339	A	RDR	PRT		101M	NONE	01/04	15:00:28	BRSZVM44	DUMP
PERFSVM	0690	A	RDR	PRT		8M	SYS	01/13	23:00:07		
MAINT	0217	T	RDR	CON		16K	SYS	12/16	12:19:02		
ESMTS109	0074	A	RDR	CON		8M	SYS	11/11	17:48:59		
SLESA100	0003	A	RDR	PUN		10M	NONE	11/11	17:38:57	INITRD	BIN
SLESA100	0001	A	RDR	PUN		7M	NONE	11/11	17:38:45	VMRDR	IKR
SLESA100	0002	A	RDR	PUN		4K	NONE	11/11	17:38:52	PARM	FILE
SLESA114	0007	A	RDR	PUN		7M	NONE	10/15	12:20:46	VMRDR	IKR
SLESA114	0009	A	RDR	PUN		10M	NONE	10/15	12:20:50	INITRD	BIN
RHAT104	0059	A	RDR	PUN		16M	NONE	09/10	11:01:13	INITRD	IMG
SINE	0150	A	RDR	PUN		17M	NONE	09/10	10:55:21	INITRD	IMG
ESMTS109	0072	A	RDR	CON		4K	NONE	10/27	15:20:07		
ESMTS109	0071	A	RDR	CON		4K	NONE	10/27	09:33:25		
ESMTS109	0070	A	RDR	CON		4K	NONE	10/27	09:26:57		
ESMTS109	0069	A	RDR	CON		8K	NONE	10/27	07:44:46		
TCPMAINT	0030	A	RDR	PRT		4K	NONE	10/23	18:27:58	TCPIP	MESSAGE
OPERATOR	0039	A	RDR	PRT		4K	NONE	10/23	18:27:58	TCPIP	MESSAGE
SLESA114	0006	A	RDR	CON		1M	NONE	10/15	12:20:39		
SLESA114	0008	A	RDR	PUN		4K	NONE	10/15	12:20:50	PARM	FILE
RHAT104	0057	A	RDR	PUN		4M	NONE	09/10	11:01:10	KERNEL	IMG
RHAT100	0008	A	RDR	PUN		7M	NONE	08/29	10:00:41	VMRDR	IKR
SINE	0145	A	RDR	PUN		5M	NONE	08/29	09:50:23	BKR120	SERVLINK
SINE	0143	A	RDR	PUN		5M	NONE	08/29	09:48:36	BKR120	VMARC
SINE	0117	A	RDR	PUN		16M	NONE	08/13	12:18:54	INITRD	IMG
BKRADMIN	0021	T	RDR	CON		4K	NONE	09/23	13:29:27	WORKER	OUTPUT
RHAT104	0060	A	RDR	PUN		4K	NONE	09/10	11:01:20	REDHAT	CONF
RHAT104	0058	A	RDR	PUN		4K	NONE	09/10	11:01:13	GENERIC	PARM
RHAT104	0055	A	RDR	CON		72K	NONE	09/10	10:42:30		
SINE	0144	A	RDR	PUN		1M	NONE	08/29	09:50:18	UK27376	SERVLINK
SINE	0142	A	RDR	PUN		1M	NONE	08/29	09:48:23	UK18212	VMARC
SINE	0141	A	RDR	PUN		1M	NONE	08/29	09:46:20	UK31492	SERVLINK
SINE	0140	A	RDR	PUN		1M	NONE	08/29	09:46:12	UK18212	SERVLINK
SINE	0139	A	RDR	PUN		1M	NONE	08/29	09:46:11	UK19969	SERVLINK
SINE	0138	A	RDR	PUN		988K	NONE	08/29	09:46:11	UK23333	SERVLINK
ESMTS101	0010	A	RDR	PUN		7M	NONE	08/14	14:25:22	VMRDR	IKR
ESMTS101	0012	A	RDR	PUN		10M	NONE	08/14	14:25:25	INITRD	BIN
5697J06B	0003	T	RDR	CON		4K	NONE	08/18	14:11:31	VMFINS	CONSOLE

MA a 05/001

Connected to remote server/host 9.82.24.129 using port 23

System: ZVMV5R20 Spool: 85% Used Files: 0% Used 1 of 1075
 Max: 4.8G Max: 1655640

Cmd	Owner	File	CLS	QUE	TYP	Size	Hold	Date	Time	Name	Type
	OPMGR1	0011	A	RDR	PUN	17M	NONE	02/24	20:40:23	INITRD	IMG
	SINE	0267	A	RDR	PUN	17M	NONE	02/24	20:40:17	INITRD	IMG
	OPMGR1	0010	A	RDR	PUN	17M	NONE	02/24	20:40:11	INITRD	IMG
	SINE	0265	A	RDR	PUN	17M	NONE	02/24	20:40:03	INITRD	IMG
	MAINT	0241	T	RDR	CON	4K	NONE	02/24	14:10:31		
	SINE	0264	A	PRT	CON	12K	NONE	02/24	00:51:44		
	MAINT	0240	T	RDR	CON	4K	NONE	02/23	11:58:22		
	OPMGR1	0007	A	RDR	PUN	17M	NONE	02/23	11:48:44	INITRD	IMG
	SINE	0248	A	RDR	PUN	17M	NONE	02/23	11:46:14	INITRD	IMG
	SINE	0247	A	RDR	PUN	17M	NONE	02/23	11:45:38	INITRD	IMG
	SINE	0246	A	RDR	PUN	17M	NONE	02/23	11:45:08	INITRD	IMG
	SINE	0245	A	RDR	CON	12K	NONE	02/23	10:21:58		
	SINE	0244	A	RDR	CON	4K	NONE	02/20	23:10:25		
	SINE	0243	A	RDR	CON	4K	NONE	02/20	18:05:30		
	MAINT	0239	T	RDR	CON	4K	NONE	02/19	15:44:50		
	PERFSVM	0727	A	PRT	PRT	1M	NONE	02/19	00:00:39	FCONMON	LISTING
	PERFSVM	0726	A	PRT	PRT	1M	NONE	02/18	00:00:39	FCONMON	LISTING
	SINE	0241	A	RDR	CON	4K	NONE	02/17	09:37:41		
	SMTM	0015	T	PRT	CON	12K	NONE	02/17	08:44:08		
	RICHARD	0010	A	RDR	PUN	4K	NONE	02/17	08:41:39	SMTM	NOTE
	SINE	0240	A	RDR	PUN	4K	NONE	02/17	08:28:43	SMTM	NOTE
	SINE	0239	A	RDR	PUN	4K	NONE	02/17	08:28:43	SMTM	NOTE
	SINE	0238	A	RDR	PUN	4K	NONE	02/17	08:28:43	SMTM	NOTE
	SINE	0237	A	RDR	PUN	4K	NONE	02/17	08:28:43	SMTM	NOTE
	OPMGR1	0003	A	RDR	PUN	4K	NONE	02/17	08:28:43	SMTM	NOTE
	TCPMAINT	0038	T	RDR	CON	8K	NONE	02/17	08:28:43		
	TCPMAINT	0037	A	RDR	PRT	4K	NONE	02/17	08:28:36	TCPIP	MESSAGE
	OPERATOR	0046	A	RDR	PRT	4K	NONE	02/17	08:28:36	TCPIP	MESSAGE
	PERFSVM	0725	A	PRT	PRT	1M	NONE	02/17	00:00:39	FCONMON	LISTING
	SINE	0236	A	RDR	CON	4K	NONE	02/16	18:04:33		
	BISHOP	0048	T	RDR	CON	4K	NONE	02/16	14:08:44		
	MAINT	0238	T	RDR	CON	4K	NONE	02/16	14:05:32		
	SINE	0235	A	RDR	CON	4K	NONE	02/16	09:43:25		
	PERFSVM	0724	A	PRT	PRT	1M	NONE	02/16	00:00:39	FCONMON	LISTING
	PERFSVM	0723	A	PRT	PRT	1M	NONE	02/15	00:00:39	FCONMON	LISTING
	OPERATOR	0045	T	PRT	CON	12K	NONE	02/14	18:06:32		
	RICHARD	0008	T	PRT	CON	8K	NONE	02/14	18:04:27		
	PERFSVM	0722	A	PRT	PRT	1M	NONE	02/14	00:00:39	FCONMON	LISTING
	RICHARD	0007	A	RDR	PUN	4K	NONE	02/13	10:55:19	LNXMSG	EXEC

MA a 05/001
 Connected to remote server/host 9.82.24.129 using port 23

System: ZVMV5R20 Spool: 85% Used Files: 0% Used 1 of 1075
 Max: 4.8G Max: 1655640

Cmd	Owner	File	CLS	QUE	TYP	Size	Hold	Date	Time	Name	Type
purge	OPMGR1	0011	A	RDR	PUN	17M	NONE	02/24	20:40:23	INITRD	IMG
=	SINE	0267	A	RDR	PUN	17M	NONE	02/24	20:40:17	INITRD	IMG
=	OPMGR1	0010	A	RDR	PUN	17M	NONE	02/24	20:40:11	INITRD	IMG
=	SINE	0265	A	RDR	PUN	17M	NONE	02/24	20:40:03	INITRD	IMG
	MAINT	0241	T	RDR	CON	4K	NONE	02/24	14:10:31		
	SINE	0264	A	PRT	CON	12K	NONE	02/24	00:51:44		
	MAINT	0240	T	RDR	CON	4K	NONE	02/23	11:58:22		
	OPMGR1	0007	A	RDR	PUN	17M	NONE	02/23	11:48:44	INITRD	IMG
	SINE	0248	A	RDR	PUN	17M	NONE	02/23	11:46:14	INITRD	IMG
	SINE	0247	A	RDR	PUN	17M	NONE	02/23	11:45:38	INITRD	IMG
	SINE	0246	A	RDR	PUN	17M	NONE	02/23	11:45:08	INITRD	IMG
	SINE	0245	A	RDR	CON	12K	NONE	02/23	10:21:58		
	SINE	0244	A	RDR	CON	4K	NONE	02/20	23:10:25		
	SINE	0243	A	RDR	CON	4K	NONE	02/20	18:05:30		
	MAINT	0239	T	RDR	CON	4K	NONE	02/19	15:44:50		
	PERFSVM	0727	A	PRT	PRT	1M	NONE	02/19	00:00:39	FCONMON	LISTING
	PERFSVM	0726	A	PRT	PRT	1M	NONE	02/18	00:00:39	FCONMON	LISTING
	SINE	0241	A	RDR	CON	4K	NONE	02/17	09:37:41		
	SMTM	0015	T	PRT	CON	12K	NONE	02/17	08:44:08		
	RICHARD	0010	A	RDR	PUN	4K	NONE	02/17	08:41:39	SMTP	NOTE
	SINE	0240	A	RDR	PUN	4K	NONE	02/17	08:28:43	SMTP	NOTE
	SINE	0239	A	RDR	PUN	4K	NONE	02/17	08:28:43	SMTP	NOTE
	SINE	0238	A	RDR	PUN	4K	NONE	02/17	08:28:43	SMTP	NOTE
	SINE	0237	A	RDR	PUN	4K	NONE	02/17	08:28:43	SMTP	NOTE
	OPMGR1	0003	A	RDR	PUN	4K	NONE	02/17	08:28:43	SMTP	NOTE
	TCPMANT	0038	T	RDR	CON	8K	NONE	02/17	08:28:43		
	TCPMANT	0037	A	RDR	PRT	4K	NONE	02/17	08:28:36	TCPIP	MESSAGE
	OPERATOR	0046	A	RDR	PRT	4K	NONE	02/17	08:28:36	TCPIP	MESSAGE
	PERFSVM	0725	A	PRT	PRT	1M	NONE	02/17	00:00:39	FCONMON	LISTING
	SINE	0236	A	RDR	CON	4K	NONE	02/16	18:04:33		
	BISHOP	0048	T	RDR	CON	4K	NONE	02/16	14:08:44		
	MAINT	0238	T	RDR	CON	4K	NONE	02/16	14:05:32		
	SINE	0235	A	RDR	CON	4K	NONE	02/16	09:43:25		
	PERFSVM	0724	A	PRT	PRT	1M	NONE	02/16	00:00:39	FCONMON	LISTING
	PERFSVM	0723	A	PRT	PRT	1M	NONE	02/15	00:00:39	FCONMON	LISTING
	OPERATOR	0045	T	PRT	CON	12K	NONE	02/14	18:06:32		
	RICHARD	0008	T	PRT	CON	8K	NONE	02/14	18:04:27		
	PERFSVM	0722	A	PRT	PRT	1M	NONE	02/14	00:00:39	FCONMON	LISTING
	RICHARD	0007	A	RDR	PUN	4K	NONE	02/13	10:55:19	LNMSG	EXEC

MA a 08/002
 Connected to remote server/host 9.82.24.129 using port 23

A - ATS Demo

File Edit View Communication Actions Window Help

System: ZVMV5R20 Spool: 84% Used Files: 0% Used 1 of 1071
 Max: 4.8G Max: 1655640

Cmd	Owner	File	CLS	QUE	TYP	Size	Hold	Date	Time	Name	Type
MAINT		0241	T	RDR	CON	4K	NONE	02/24	14:10:31		
SINE		0264	A	PRT	CON	12K	NONE	02/24	00:51:44		
MAINT		0240	T	RDR	CON	4K	NONE	02/23	11:58:22		
OPMGR1		0007	A	RDR	PUN	17M	NONE	02/23	11:48:44	INITRD	IMG
SINE		0248	A	RDR	PUN	17M	NONE	02/23	11:46:14	INITRD	IMG
SINE		0247	A	RDR	PUN	17M	NONE	02/23	11:45:38	INITRD	IMG
SINE		0246	A	RDR	PUN	17M	NONE	02/23	11:45:08	INITRD	IMG
SINE		0245	A	RDR	CON	12K	NONE	02/23	10:21:58		
SINE		0244	A	RDR	CON	4K	NONE	02/20	23:10:25		
SINE		0243	A	RDR	CON	4K	NONE	02/20	18:05:30		
MAINT		0239	T	RDR	CON	4K	NONE	02/19	15:44:50		
PERFSVM		0727	A	PRT	PRT	1M	NONE	02/19	00:00:39	FCONMON	LISTING
PERFSVM		0726	A	PRT	PRT	1M	NONE	02/18	00:00:39	FCONMON	LISTING
SINE		0241	A	RDR	CON	4K	NONE	02/17	09:37:41		
SMTP		0015	T	PRT	CON	12K	NONE	02/17	08:44:08		
RICHARD		0010	A	RDR	PUN	4K	NONE	02/17	08:41:39	SMTP	NOTE
SINE		0240	A	RDR	PUN	4K	NONE	02/17	08:28:43	SMTP	NOTE
SINE		0239	A	RDR	PUN	4K	NONE	02/17	08:28:43	SMTP	NOTE
SINE		0238	A	RDR	PUN	4K	NONE	02/17	08:28:43	SMTP	NOTE
SINE		0237	A	RDR	PUN	4K	NONE	02/17	08:28:43	SMTP	NOTE
OPMGR1		0003	A	RDR	PUN	4K	NONE	02/17	08:28:43	SMTP	NOTE
TCPMAINT		0038	T	RDR	CON	8K	NONE	02/17	08:28:43		
TCPMAINT		0037	A	RDR	PRT	4K	NONE	02/17	08:28:36	TCPIP	MESSAGE
OPERATOR		0046	A	RDR	PRT	4K	NONE	02/17	08:28:36	TCPIP	MESSAGE
PERFSVM		0725	A	PRT	PRT	1M	NONE	02/17	00:00:39	FCONMON	LISTING
SINE		0236	A	RDR	CON	4K	NONE	02/16	18:04:33		
BISHOP		0048	T	RDR	CON	4K	NONE	02/16	14:08:44		
MAINT		0238	T	RDR	CON	4K	NONE	02/16	14:05:32		
SINE		0235	A	RDR	CON	4K	NONE	02/16	09:43:25		
PERFSVM		0724	A	PRT	PRT	1M	NONE	02/16	00:00:39	FCONMON	LISTING
PERFSVM		0723	A	PRT	PRT	1M	NONE	02/15	00:00:39	FCONMON	LISTING
OPERATOR		0045	T	PRT	CON	12K	NONE	02/14	18:06:32		
RICHARD		0008	T	PRT	CON	8K	NONE	02/14	18:04:27		
PERFSVM		0722	A	PRT	PRT	1M	NONE	02/14	00:00:39	FCONMON	LISTING
RICHARD		0007	A	RDR	PUN	4K	NONE	02/13	10:55:19	LNXMMSG	EXEC
PERFSVM		0721	A	PRT	PRT	1M	NONE	02/13	00:00:39	FCONMON	LISTING
PERFSVM		0720	A	PRT	PRT	1M	NONE	02/12	00:00:39	FCONMON	LISTING
ESMTS103		0020	A	PRT	CON	3M	NONE	02/11	20:08:57		
PERFSVM		0719	A	PRT	PRT	1M	NONE	02/11	00:00:39	FCONMON	LISTING

MA a 05 / 001

Connected to remote server/host 9.82.24.129 using port 23

```

A - ATS Demo
File Edit View Communication Actions Window Help
02/24/2009 20:52:48 GOMACT0267I ACTION SPL7 END RC=0 SERVER OPMGRM1
02/24/2009 20:52:48 GOMCMD0216L SMTP /* From SMTP: Received Spool File 006
02/24/2009 20:52:48 GOMCMD0216L SMTP /* From SMTP: Mail delivered to: <TLD
02/24/2009 20:53:48 GOMSMO0403I SPOOL ALERT: MONITOR SPL7 USAGE CONDITI
02/24/2009 20:53:48 GOMSMO0401I SPOOL USE: MONITOR SPL7 SPACE 85 PERCENT,
02/24/2009 20:53:48 GOMSMO0402I SPOOL CHG: MONITOR SPL7 SPACE 0 PERCENT, F
02/24/2009 20:53:48 GOMACT0260I SPOOL SPL7 ACTION SPL7 TRIGGERED BY
02/24/2009 20:53:48 GOMACT0262I ACTION SPL7 BEGIN FOR SPOOL SERVER OPMG
02/24/2009 20:53:48 GOMACT0269L COMMAND "EXEC SMTPNOTE TLD1 AT US.IBM.COM SPOO
02/24/2009 20:53:48 GOMACT0270L DMSXSU587I XEDIT:
02/24/2009 20:53:48 GOMACT0270L NOTE OPMGRM1 NOTE A1 sent to TLD1 at US.IBM.CO
02/24/2009 20:53:48 GOMACT0267I ACTION SPL7 END RC=0 SERVER OPMGRM1
02/24/2009 20:53:48 GOMCMD0216L SMTP /* From SMTP: Received Spool File 006
02/24/2009 20:53:48 GOMCMD0216L SMTP /* From SMTP: Mail delivered to: <TLD
02/24/2009 20:54:48 GOMSMO0403I SPOOL ALERT: MONITOR SPL7 USAGE CONDITI
02/24/2009 20:54:48 GOMSMO0401I SPOOL USE: MONITOR SPL7 SPACE 85 PERCENT,
02/24/2009 20:54:48 GOMSMO0402I SPOOL CHG: MONITOR SPL7 SPACE 0 PERCENT, F
02/24/2009 20:54:48 GOMACT0260I SPOOL SPL7 ACTION SPL7 TRIGGERED BY
02/24/2009 20:54:48 GOMACT0262I ACTION SPL7 BEGIN FOR SPOOL SERVER OPMG
02/24/2009 20:54:48 GOMACT0269L COMMAND "EXEC SMTPNOTE TLD1 AT US.IBM.COM SPOO
02/24/2009 20:54:48 GOMACT0270L DMSXSU587I XEDIT:
02/24/2009 20:54:48 GOMACT0270L NOTE OPMGRM1 NOTE A1 sent to TLD1 at US.IBM.CO
02/24/2009 20:54:48 GOMACT0267I ACTION SPL7 END RC=0 SERVER OPMGRM1
02/24/2009 20:54:48 GOMCMD0216L SMTP /* From SMTP: Received Spool File 007
02/24/2009 20:54:48 GOMCMD0216L SMTP /* From SMTP: Mail delivered to: <TLD
02/24/2009 20:55:48 GOMSMO0403I SPOOL ALERT: MONITOR SPL7 USAGE CONDITI
02/24/2009 20:55:48 GOMSMO0401I SPOOL USE: MONITOR SPL7 SPACE 85 PERCENT,
02/24/2009 20:55:48 GOMSMO0402I SPOOL CHG: MONITOR SPL7 SPACE 0 PERCENT, F
02/24/2009 20:55:48 GOMACT0260I SPOOL SPL7 ACTION SPL7 TRIGGERED BY
02/24/2009 20:55:48 GOMACT0262I ACTION SPL7 BEGIN FOR SPOOL SERVER OPMG
02/24/2009 20:55:48 GOMACT0269L COMMAND "EXEC SMTPNOTE TLD1 AT US.IBM.COM SPOO
02/24/2009 20:55:48 GOMACT0270L DMSXSU587I XEDIT:
02/24/2009 20:55:48 GOMACT0270L NOTE OPMGRM1 NOTE A1 sent to TLD1 at US.IBM.CO
02/24/2009 20:55:48 GOMACT0267I ACTION SPL7 END RC=0 SERVER OPMGRM1
02/24/2009 20:55:48 GOMCMD0216L SMTP /* From SMTP: Received Spool File 007
02/24/2009 20:55:48 GOMCMD0216L SMTP /* From SMTP: Mail delivered to: <TLD
02/24/2009 20:56:41 GOMCMD0223I USER SINE ISSUED COMMAND "PURGE OPMGRG1 R
02/24/2009 20:56:41 GOMCMD0223I USER SINE ISSUED COMMAND "PURGE SINE R
02/24/2009 20:56:41 GOMCMD0223I USER SINE ISSUED COMMAND "PURGE OPMGRG1 R
02/24/2009 20:56:41 GOMCMD0223I USER SINE ISSUED COMMAND "PURGE SINE R
02/24/2009 20:58:59 GOMCMD0201L SINE "VIEWLOG" VID=SINE SRC=MASIUCV C
MASALOG (Scroll)
MA a 42/001
Connected to remote server/host 9.82.24.129 using port 23

```

Scenario 5: Automated Spool Clean Up

- **Use z/VM SFPURGER utility to manage spool files based on criteria, e.g.**
 - User ID
 - Days in spool
 - Class
 - Number of records
- **Automate SFPURGER execution**
 - Regularly scheduled using Operations Manager
 - Triggered by Operations Manager spool monitor

Scenario 5: Detailed Steps

- **From an authorized VM user ID, view the spool files for a specific user:**

```
gomcmd opmgrm1 viewspl user(tstadmin2)
```

- **Send a file to this user as class Z**

```
sendfile profile exec a tstadmin2 (class z
```

- **View spool files for this user again to see the new file**

```
gomcmd opmgrm1 viewspl user(tstadmin2)
```

- **Delete any existing schedules called DEMO**

```
gomcmd opmgrm1 delschd name(demo)
```

- **Schedule SFPURGER for execution**

- It will purge any files of class Z

```
gomcmd opmgrm1 defschd name(demo),action(sfpurger),WHEN(now)
```

- **View spool files for this user again to see the new file is gone**

```
gomcmd opmgrm1 viewspl user(tstadmin2)
```

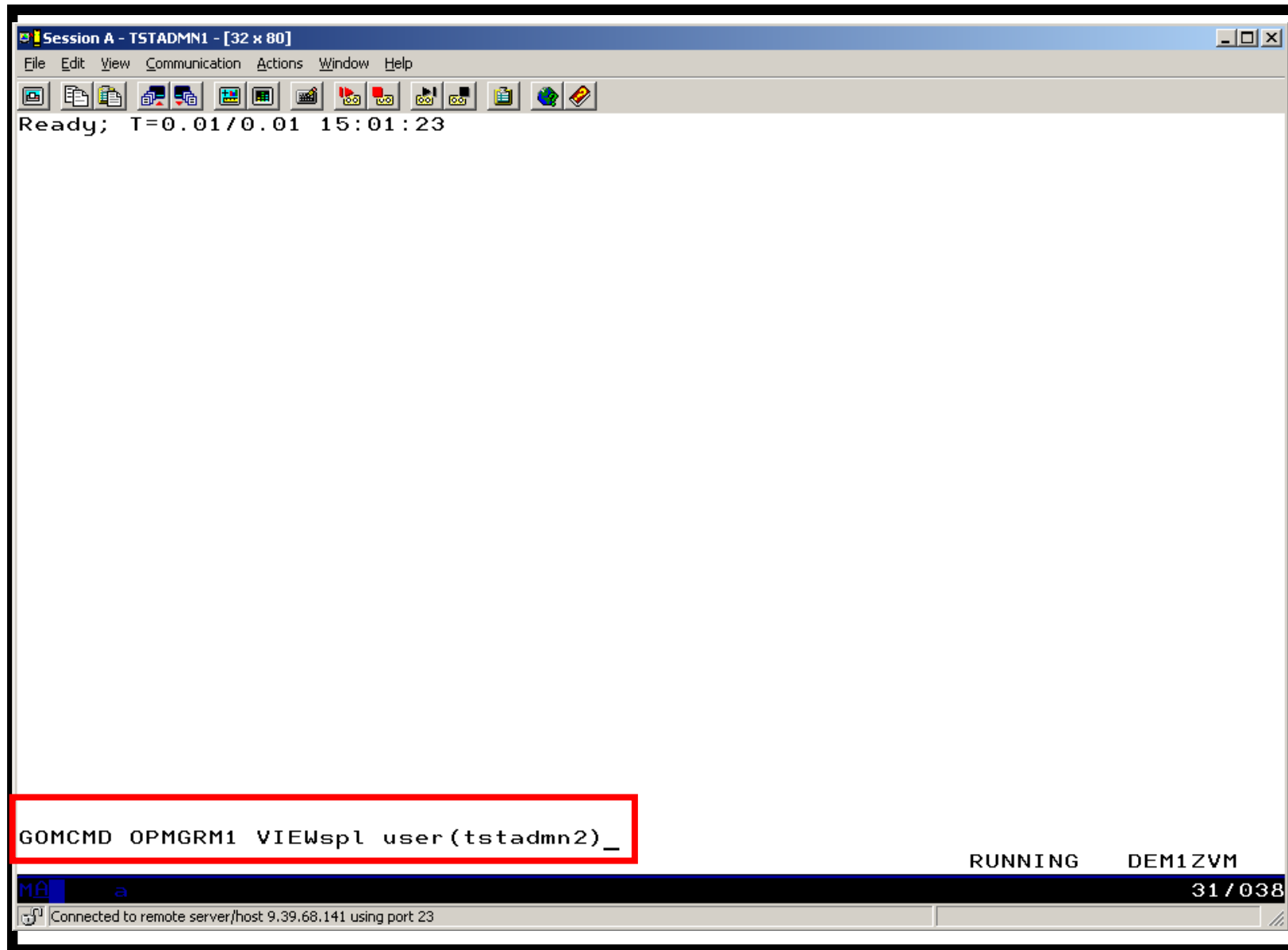

Session A - TSTADMN1 - [32 x 80]

File Edit View Communication Actions Window Help

System: DEM1ZVM Spool: 5% Used Files: 0% Used 1 of 2
 Max: 2.4G Max: 1655640

Cmd	Owner	File	CLS	QUE	TYP	Size	Hold	Date	Time	Name	Type
	TSTADMN2	0004	A	RDR	PUN	576K	NONE	04/20	04:55:56	AMV1004	BADARC
	TSTADMN2	0006	A	RDR	PUN	64K	NONE	08/25	11:07:21	TSTADMN1	NETLOG

MA a 05/001

Connected to remote server/host 9.39.68.141 using port 23

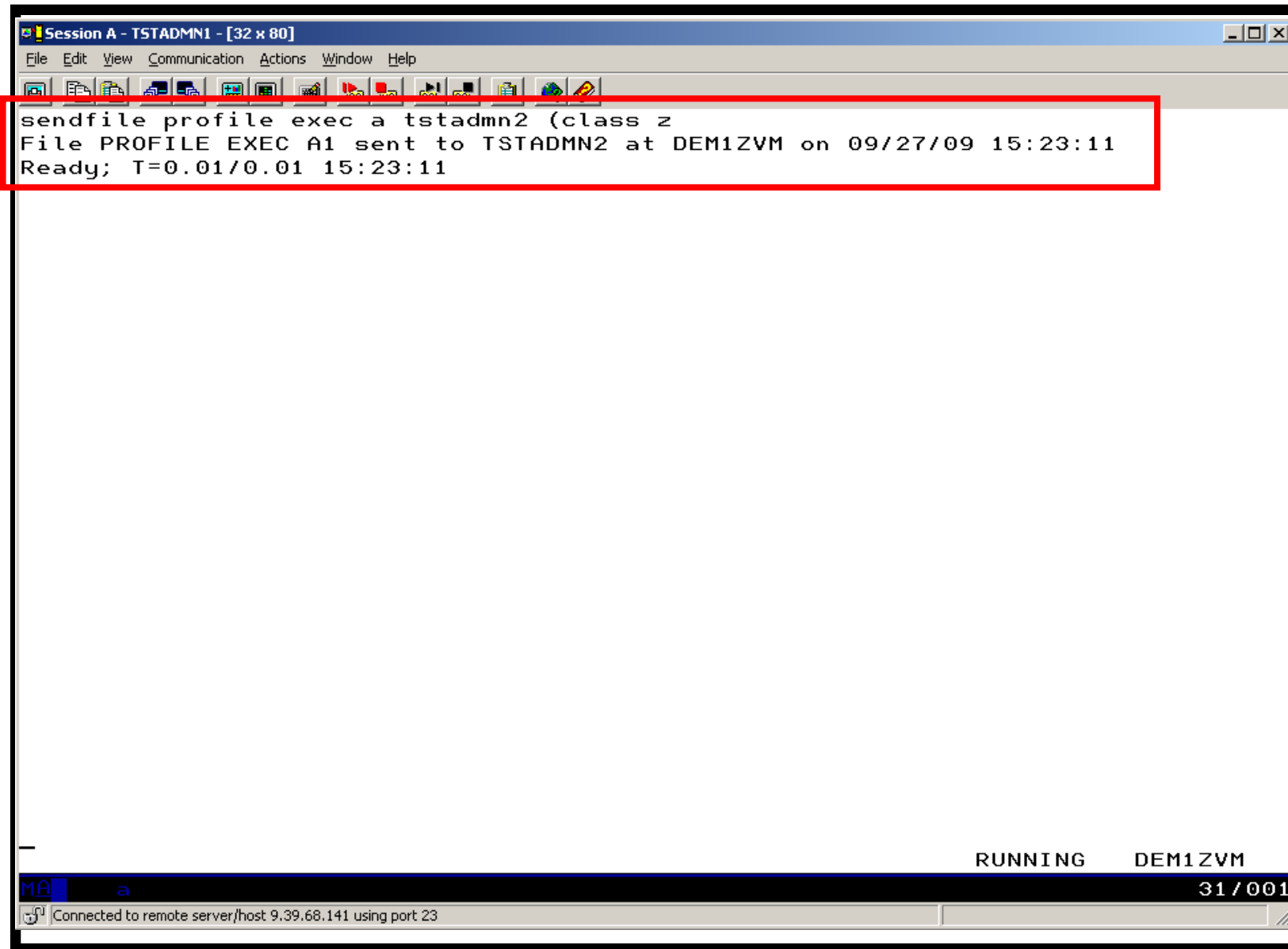

The image shows a terminal window titled "Session A - TSTADMN1 - [32 x 80]". The window has a menu bar with "File", "Edit", "View", "Communication", "Actions", "Window", and "Help". Below the menu bar is a toolbar with various icons. The main area of the terminal displays the following text:

```
sendfile profile exec a tstadm2 (class z  
File PROFILE EXEC A1 sent to TSTADMN2 at DEM1ZVM on 09/27/09 15:23:11  
Ready; T=0.01/0.01 15:23:11
```

A red rectangular box highlights the first three lines of the terminal output. At the bottom of the terminal window, there is a status bar with the text "RUNNING DEM1ZVM" and "31 / 001". Below the status bar, there is a small icon and the text "Connected to remote server/host 9.39.68.141 using port 23".

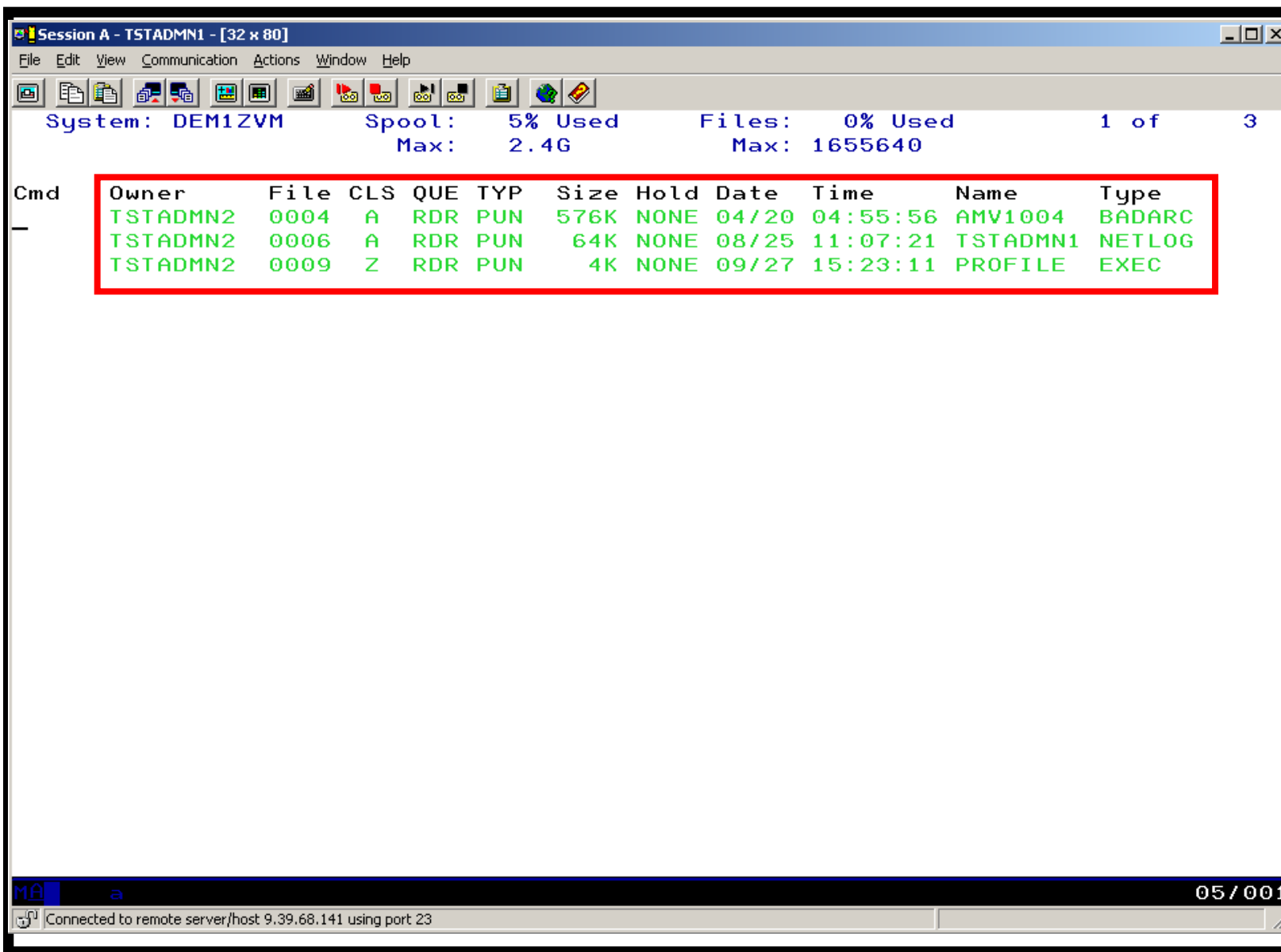

Session A - TSTADMN1 - [32 x 80]

File Edit View Communication Actions Window Help

System: DEM1ZVM Spool: 5% Used Files: 0% Used 1 of 3
Max: 2.4G Max: 1655640

Owner	File	CLS	QUE	TYP	Size	Hold	Date	Time	Name	Type
TSTADMN2	0004	A	RDR	PUN	576K	NONE	04/20	04:55:56	AMV1004	BADARC
TSTADMN2	0006	A	RDR	PUN	64K	NONE	08/25	11:07:21	TSTADMN1	NETLOG
TSTADMN2	0009	Z	RDR	PUN	4K	NONE	09/27	15:23:11	PROFILE	EXEC

Cmd

MA a 05/001

Connected to remote server/host 9.39.68.141 using port 23

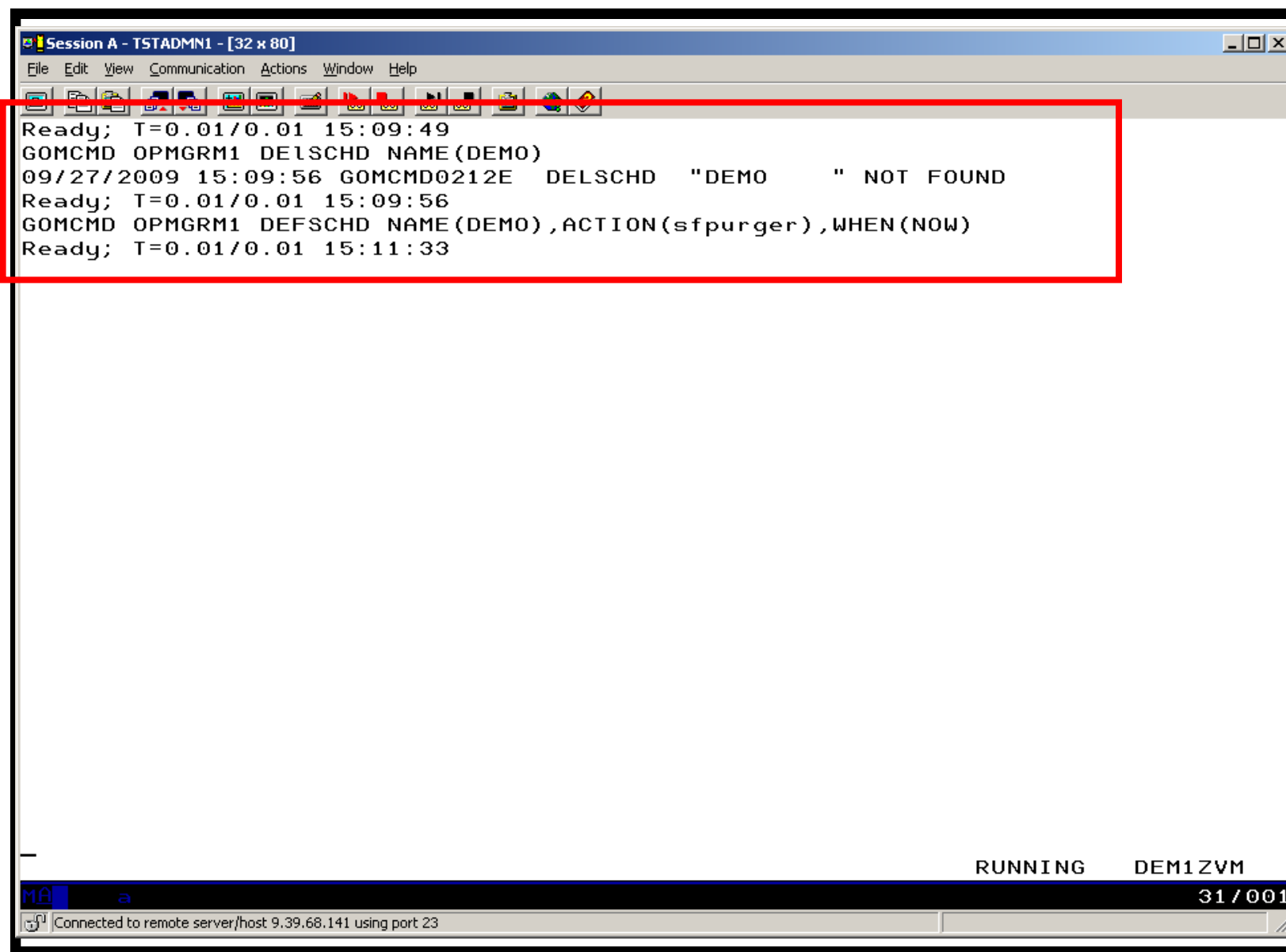

```
Session A - TSTADMIN1 - [32 x 80]
File Edit View Communication Actions Window Help
Ready; T=0.01/0.01 15:09:49
GOMCMD OPMGRM1 DELSCHD NAME(DEMO)
09/27/2009 15:09:56 GOMCMD0212E  DELSCHD  "DEMO  " NOT FOUND
Ready; T=0.01/0.01 15:09:56
GOMCMD OPMGRM1 DEFSCHD NAME(DEMO),ACTION(sfpurger),WHEN(NOW)
Ready; T=0.01/0.01 15:11:33

RUNNING DEM1ZVM
31/001
Connected to remote server/host 9.39.68.141 using port 23
```



```

Session A - TSTADMN1 - [32 x 80]
File Edit View Communication Actions Window Help
09/27/2009 15:26:29 GOMCMD0216L LYSYSLOG "/11>DB2[2009]: Open of log file "/ba
09/27/2009 15:26:37 GOMCMD0201L TSTADMN1 "DELSCHD NAME(DEMO)" VID=TSTADMN1 SRC
09/27/2009 15:26:37 GOMCMD0201L TSTADMN1 "DEFSCHD NAME(DEMO),ACTION(SFPURGER),
09/27/2009 15:26:49 GOMCMD0201L TSTADMN1 "VIEWLOG" VID=TSTADMN1 SRC=MASIUCV C
09/27/2009 15:26:59 GOMACT0260I SCHEDULE DEMO ACTION SFPURGER TRIGGERED BY
09/27/2009 15:26:59 GOMACT0262I ACTION SFPURGER BEGIN FOR SCHEDULE SERVER OPMG
09/27/2009 15:26:59 GOMACT0269L COMMAND "EXEC SFPURGER FORCE"
09/27/2009 15:26:59 GOMACT0270L DMSCYS2469I SFPURGER OPTIONS file processed ..
09/27/2009 15:26:59 GOMACT0270L DMSCYS2452I SFPURGER starting at 15:26:59 on 2
09/27/2009 15:26:59 GOMACT0270L DMSCYS2453I Running in FORCE mode - RUN09270.
09/27/2009 15:26:59 GOMACT0270L DMSCYS2470I Using SFPURGER MODULE with SFPTRAC
09/27/2009 15:26:59 GOMACT0270L DMSCYS2456I Erasing old output files till 2009
09/27/2009 15:26:59 GOMACT0270L
09/27/2009 15:26:59 GOMACT0270L DMSCYS2496I Control card scan complete.
09/27/2009 15:26:59 GOMACT0270L
09/27/2009 15:26:59 GOMACT0270L DMSCYS2459I Examining output file ...
09/27/2009 15:26:59 GOMACT0270L DMSCYS2462I Spool file scanning begins ...
09/27/2009 15:26:59 GOMACT0270L DMSCYS2482I Executing: CP PURGE TSTADMN2 RDR 0
09/27/2009 15:26:59 GOMACT0270L 0000001 FILE PURGED
09/27/2009 15:26:59 GOMACT0270L DMSCYS2463I 1 of the 286 spool files HAVE been
09/27/2009 15:26:59 GOMACT0270L DMSCYS2485I 0 of the 286 spool files HAVE been
09/27/2009 15:26:59 GOMACT0270L DMSCYS2486I 0 of the 286 spool files HAVE been
09/27/2009 15:26:59 GOMACT0270L RDR FILE 0014 SENT FROM OPMGRM1 CON WAS 0014
09/27/2009 15:26:59 GOMACT0270L DMSCYS2466I Run terminating - Return code 0.
09/27/2009 15:26:59 GOMACT0270L DMSCYS2465I SFPURGER RUN09270 has ended.
09/27/2009 15:26:59 GOMACT0267I ACTION SFPURGER END RC=0 SERVER OPMGRM1
09/27/2009 15:26:59 GOMCMD0216L OPERATOR "OPMGRM1: DMSCYS2452I SFPURGER starti
09/27/2009 15:26:59 GOMCMD0216L OPERATOR "OPMGRM1: DMSCYS2453I Running in FORC
09/27/2009 15:26:59 GOMCMD0216L OPERATOR "OPMGRM1: DMSCYS2456I Erasing old out
09/27/2009 15:26:59 GOMCMD0216L OPERATOR "OPMGRM1: DMSCYS2459I Examining outpu

MASALOG
MA a 31/001
Connected to remote server/host 9.39.68.141 using port 23

```

Session A - TSTADMN1 - [32 x 80]

File Edit View Communication Actions Window Help

System: DEM1ZVM Spool: 5% Used Files: 0% Used 1 of 2
 Max: 2.4G Max: 1655640

Cmd	Owner	File	CLS	QUE	TYP	Size	Hold	Date	Time	Name	Type
-	TSTADMN2	0004	A	RDR	PUN	576K	NONE	04/20	04:55:56	AMV1004	BADARC
-	TSTADMN2	0006	A	RDR	PUN	64K	NONE	08/25	11:07:21	TSTADMN1	NETLOG

MA a 05/001

Connected to remote server/host 9.39.68.141 using port 23

Scenario 5: How Do You Do That?

Action in Operations Manager to call z/VM's SFPURGER EXEC

```
*  
DEFACTN NAME(SFPURGER),+  
  COMMAND(EXEC SFPURGER FORCE),+  
  OUTPUT(LOG),+  
  ENV(LVM)
```

SFPURGER OPTIONS file

```
* Send console log to user ID TSTADMN1 at demo node  
CONSOLE  TSTADMN1 DEM1ZVM  
* Erase LOG and RUN files that are more than 3 days old  
KEEPDAY  21  
* Set prime shift start and end times  
PRIMSHFT  07:30:00 16:30:00  
* Use defaults for the following:  
*  MSGTYPE  SORTMOD  SFPCNTL  SOSCNTL  SFPMOD  APPEND  
SFPCNTL  SFPTRACY
```

Scenario 5: How Do You Do That?

SFPTRACY CONTROL

* Ignore any spool files found in the NSS queue (privilege class E)

```
QUEUE NSS                                ACTION IGNORE
```

*

* Purge any spool files found in class Z

```
CLASS Z                                  ACTION PURGE
```

Make sure OPMGRM1 links and accesses MAINT 193 disk for access to SFPURGER functions

Scenario 6: Detecting Disk Full Conditions of Logging IDs

- **Operations Manager monitors the console of a user ID that does logging**
 - DIRMAINT, for example
- **Disk full or early warning message triggers a rule/action in Operations Manager**
 - Quiesce or shut down DIRMAINT
 - Send the log files to a separate service machine
 - Erase the log files from DIRMAINT's logging disk
 - Restart DIRMAINT
 - Separately, other service machine automatically archives all files it receives (in Archive Manager for z/VM)
 - Log files are safely archived in Archive Manager and DIRMAINT is running with a clean log disk
- **Get a copy of the console for further review/debugging**

Scenario 6: Detailed Steps

- **From an authorized VM user ID, view the DIRMAINT console:**

```
gomcmd opmgrml viewcon user(dirmaint)
```

- **In the console view**

- Issue CMS commands to copy old (large) log files to DIRMAINT's log disk

```
cms copyfile dirmaint tlog0914 t = tlog0912 h
```

- Verify the logging disk is more than 75% full

```
cms q disk
```

- Run DIRMAINT's hourly processing now

```
exec dvhourly
```

- Verify the logging disk is less than 75% full

```
cms q disk
```

- **Exit the console view and find the files in the archive**

```
amvlist
```

- Type "archlogs" in the owner field and press ENTER

- **Request a copy of the console for further review/debugging**

```
gomcmd opmgrml viewcon user(dirmaint),mode(rdr)
```

```

Session B - TSTADMN1 - [32 x 80]
File Edit View Communication Actions Window Help
DIRMAINT DEM1ZVM. - 2009/02/24; T=0.01/0.01 22:56:04
DVMHAI2140I Waiting for work on 09/02/24 at 22:56:04.
DVMHAI2143I Wakeup caused by timer file entry on 09/02/24 at 23:01:02.
DVMHAI2143I Processing event number 00005 scheduled for ==/==/== at
DVMHAI2143I +01:00:0.
DIRMAINT DEM1ZVM. - 2009/02/24; T=0.02/0.02 23:01:02
DVMHREQ2290I Request is: CMS EXEC DVHOURLY
DVMHREQ2288I Your CMS request for DIRMAINT at * has been accepted.
DVMHRLY3886I Hourly processing started; with 0 log
DVMHRLY3886I files.
DVMHREQ2289I Your CMS request for DIRMAINT at * has completed; with RC
DVMHREQ2289I = 0.
DIRMAINT DEM1ZVM. - 2009/02/24; T=0.03/0.03 23:01:03
DVMHAI2140I Waiting for work on 09/02/24 at 23:01:03.
DVMHAI2142I Wakeup caused by elapsed time on 09/02/24 at 23:06:03.
DIRMAINT DEM1ZVM. - 2009/02/24; T=0.01/0.01 23:06:03
DVMHAI2140I Waiting for work on 09/02/24 at 23:06:03.
DVMHAI2142I Wakeup caused by elapsed time on 09/02/24 at 23:11:03.
DIRMAINT DEM1ZVM. - 2009/02/24; T=0.01/0.01 23:11:03
DVMHAI2140I Waiting for work on 09/02/24 at 23:11:03.
* -- Operations Manager VIEWCON session from TSTADMN1 entered the following --
cms acc 333 t
DVMHAI2146I Wakeup caused by console attention on 09/02/24 at 23:12:15.
DIRMAINT DEM1ZVM. - 2009/02/24; T=0.01/0.01 23:12:16
DVMHREQ2290I Request is: CMS acc 333 t
DVMHREQ2288I Your CMS request for DIRMAINT at * has been accepted.
DVMHREQ2289I Your CMS request for DIRMAINT at * has completed; with RC
DVMHREQ2289I = 0.
DIRMAINT DEM1ZVM. - 2009/02/24; T=0.02/0.03 23:12:17
DVMHAI2140I Waiting for work on 09/02/24 at 23:12:17.
cms copyfile dirmaint tlog0914 t = tlog0912 h_
DIRMAINT (Scroll)
MA b 01/046
Connected to remote server/host 9.39.68.141 using port 23

```

```
Session B - TSTADMN1 - [32 x 80]
File Edit View Communication Actions Window Help
DVMHAI2140I Waiting for work on 09/02/24 at 23:01:03.
DVMHAI2142I Wakeup caused by elapsed time on 09/02/24 at 23:06:03.
DIRMAINT DEM1ZVM. - 2009/02/24; T=0.01/0.01 23:06:03
DVMHAI2140I Waiting for work on 09/02/24 at 23:06:03.
DVMHAI2142I Wakeup caused by elapsed time on 09/02/24 at 23:11:03.
DIRMAINT DEM1ZVM. - 2009/02/24; T=0.01/0.01 23:11:03
DVMHAI2140I Waiting for work on 09/02/24 at 23:11:03.
* -- Operations Manager VIEWCON session from TSTADMN1 entered the following --
cms acc 333 t
DVMHAI2146I Wakeup caused by console attention on 09/02/24 at 23:12:15.
DIRMAINT DEM1ZVM. - 2009/02/24; T=0.01/0.01 23:12:16
DVMHREQ2290I Request is: CMS acc 333 t
DVMHREQ2288I Your CMS request for DIRMAINT at * has been accepted.
DVMHREQ2289I Your CMS request for DIRMAINT at * has completed; with RC
DVMHREQ2289I = 0.
DIRMAINT DEM1ZVM. - 2009/02/24; T=0.02/0.03 23:12:17
DVMHAI2140I Waiting for work on 09/02/24 at 23:12:17.
* -- Operations Manager VIEWCON session from TSTADMN1 entered the following --
cms copyfile dirmaint tlog0914 t = tlog0912 h
DVMHAI2146I Wakeup caused by console attention on 09/02/24 at 23:14:06.
DIRMAINT DEM1ZVM. - 2009/02/24; T=0.01/0.01 23:14:06
DVMHREQ2290I Request is: CMS copyfile dirmaint tlog0914 t = tlog0912 h
DVMHREQ2288I Your CMS request for DIRMAINT at * has been accepted.
DVMHREQ2289I Your CMS request for DIRMAINT at * has completed; with RC
DVMHREQ2289I = 0.
DIRMAINT DEM1ZVM. - 2009/02/24; T=0.03/0.03 23:14:08
DVMHAI2140I Waiting for work on 09/02/24 at 23:14:08.
DVMHAI2142I Wakeup caused by elapsed time on 09/02/24 at 23:19:08.
DIRMAINT DEM1ZVM. - 2009/02/24; T=0.01/0.01 23:19:08
DVMHAI2140I Waiting for work on 09/02/24 at 23:19:08.
-
DIRMAINT (Scroll)
MA b 31/001
Connected to remote server/host 9.39.68.141 using port 23
```



```

Session B - TSTADMN1 - [32 x 80]
File Edit View Communication Actions Window Help
cms copyfile dirmaint tlog0914 t = tlog0910 h
DVHWAI2146I Wakeup caused by console attention on 09/02/24 at 23:24:42.
DIRMAINT DEM1ZVM. - 2009/02/24; T=0.01/0.01 23:24:42
DVHREQ2290I Request is: CMS copyfile dirmaint tlog0914 t = tlog0910 h
DVHREQ2288I Your CMS request for DIRMAINT at * has been accepted.
DVHREQ2289I Your CMS request for DIRMAINT at * has completed; with RC
DVHREQ2289I = 0.
DIRMAINT DEM1ZVM. - 2009/02/24; T=0.03/0.03 23:24:43
DVHWAI2140I Waiting for work on 09/02/24 at 23:24:43
* -- Operations Manager VIEWCON session from TSTADMN1 entered the following --
cms q disk
DVHWAI2146I Wakeup caused by console attention on 09/02/24 at 23:25:08.
DIRMAINT DEM1ZVM. - 2009/02/24; T=0.01/0.01 23:25:08
DVHREQ2290I Request is: CMS q disk
DVHREQ2288I Your CMS request for DIRMAINT at * has been accepted.

```

LABEL	VDEV	M	STAT	CYL	TYPE	BLKSZ	FILES	BLKS USED-(%)	BLKS LEFT	BLK TOTA
DIR155	155	A	R/W	9	3390	4096	12	80-05	1540	162
DRM491	191	C	R/W	15	3390	4096	250	1311-49	1389	270
DRM11F	11F	D	R/W	8	3390	4096	47	568-39	872	144
DIR1DF	1DF	E	R/W	9	3390	4096	124	265-16	1355	162
DIR1DB	1DB	C	R/W	9	3390	4096	10	144-00	1476	162
DIR1AA	1AA	H	R/W	9	3390	4096	10	1385-85	235	162
MNT190	190	S	R/O	100	3390	4096	687	14513-81	3487	1800
DIR333	333	T	R/W	5	3390	4096	2	505-56	395	90
MNT19E	19E	Y/S	R/O	250	3390	4096	1102	28088-62	16912	4500
DIR1FA	1FA	Z	R/W	9	3390	4096	0	7-00	1613	162

```

DVHREQ2289I Your CMS request for DIRMAINT at * has completed; with RC
DVHREQ2289I = 0.
DIRMAINT DEM1ZVM. - 2009/02/24; T=0.02/0.03 23:25:09
DVHWAI2140I Waiting for work on 09/02/24 at 23:25:09.
-
DIRMAINT (Scroll)
MA b 31/001
Connected to remote server/host 9.39.68.141 using port 23

```

```

Session B - TSTADMN1 - [32 x 80]
File Edit View Communication Actions Window Help
23:29:24 * -- Operations Manager VIEWCON session from TSTADMN1 entered the foll
23:29:24 cms exec dvhourly
23:29:24 DVHWA12148I Wakeup caused by console attention on 09/02/24 at 23:29:24
23:29:24 DIRMAINT DEM1ZVM. - 2009/02/24; T=0.01/0.01 23:29:24
23:29:25 DVHREQ2290I Request is: CMS exec dvhourly
23:29:25 DVHREQ2288I Your CMS request for DIRMAINT at * has been accepted
23:29:25 DVHRLY3895W Disk 01AA is 75% full, exceeding its
23:29:25 * -- Operations Manager Action DIRML0GB scheduled for execution -- *
23:29:33 DVHRLY3895W WARNING threshold of 75%.
23:29:33 DVHRLY3888I Hourly processing started, with 0 log
23:29:33 DVHRLY3886I files.
23:29:33 DVHREQ2289I Your CMS request for DIRMAINT at * has completed; with RC
23:29:33 DVHREQ2289I = 0.
23:29:33 DIRMAINT DEM1ZVM. - 2009/02/24; T=0.04/0.04 23:29:25
23:29:33 DVHWA12140I Waiting for work on 09/02/24 at 23:29:25.
23:29:33 DVHWA12141I Wakeup caused by *MSG on 09/02/24 at 23:29:25 from OPMGRM
23:29:33 DIRMAINT DEM1ZVM. - 2009/02/24; T=0.01/0.01 23:29:25
23:29:33 DVHREQ2290I Request is: REQUEST 74 SHUTDOWN
23:29:33 DVHREQ2288I Your SHUTDOWN request for OPMGRM1 at * has been accepted.
23:29:33 DVHREQ2288I Your SHUTDOWN request for OPMGRM1 at * has been accepted
23:29:33 DVHSHU2193I A shutdown command has been issued by
23:29:33 DVHSHU2193I OPMGRM1 from DEM1ZVM.
23:29:33 DVHSHU2198A The DIRMAINT service machine is logging
23:29:33 DVHSHU2198A off.
23:29:33 CONNECT= 00:01:30 VIRTCPU= 000:00 40 TOTCPU= 000:00 47
23:29:33 LOGOFF AT 23:29:27 CST TUESDAY 02/24/09
23:29:33 PRT FILE 0791 SENT FROM DIRMAINT CON WAS 0791 RECS 0095 CPY 001 0 HOL
23:29:33 DASD 0191 LINKED R/W; R/O BY DATAMOVE
23:29:33 DASD 011F LINKED R/W; R/O BY DATAMOVE
23:29:33 .....
-
DIRMAINT
MA b 31 / 001
Connected to remote server/host 9.39.68.141 using port 23

```

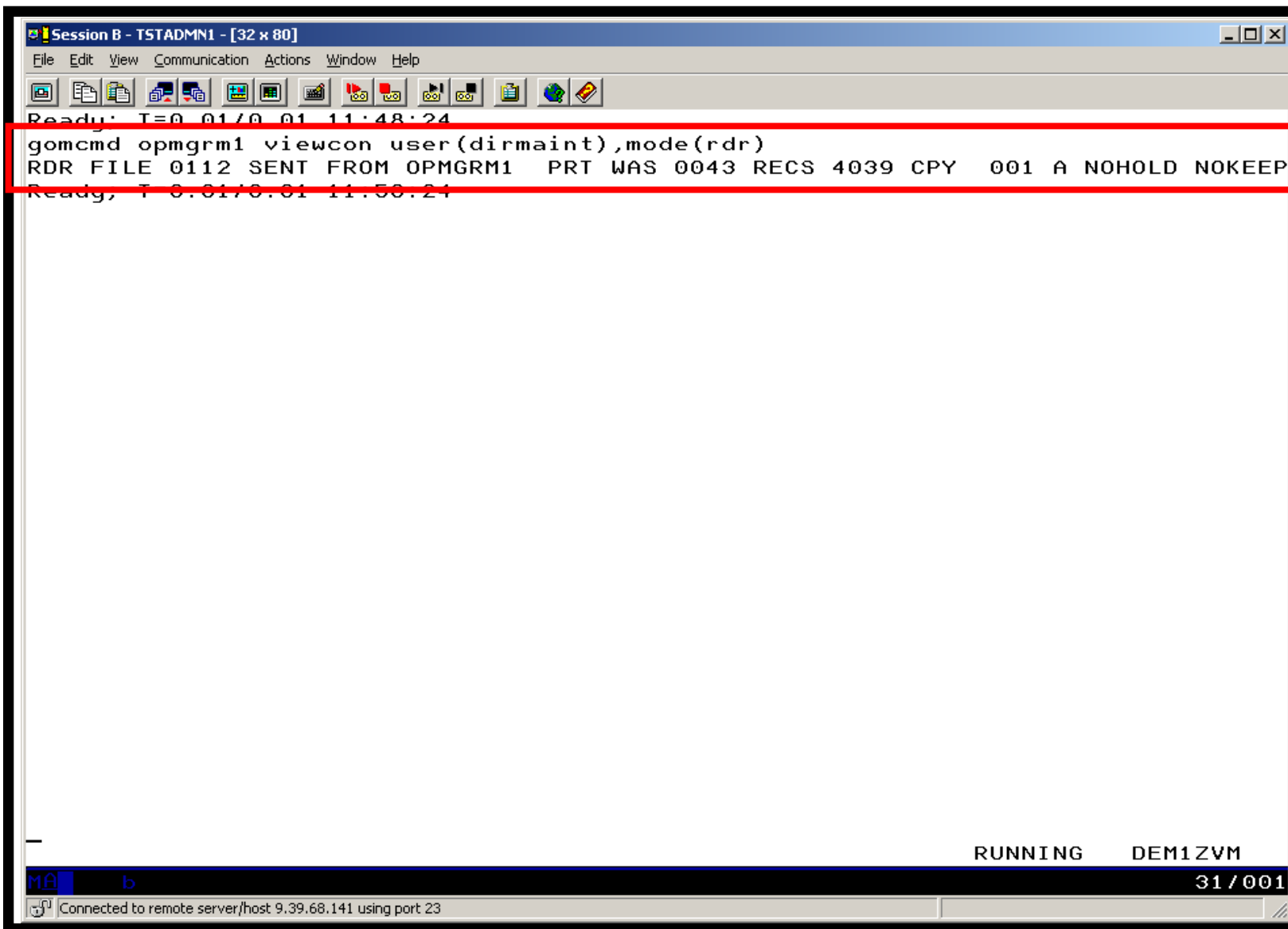

The screenshot shows a terminal window titled "Session B - TSTADMIN1 - [32 x 80]". The window has a menu bar with "File", "Edit", "View", "Communication", "Actions", "Window", and "Help". Below the menu bar is a toolbar with various icons. The terminal content is as follows:

```
Ready; T=0.01/0.01 11:48:24  
gomcmd opmgrm1 viewcon user(dirmaint),mode(rdr)  
RDR FILE 0112 SENT FROM OPMGRM1 PRT WAS 0043 RECS 4039 CPY 001 A NOHOLD NOKEEP  
Ready; T=0.01/0.01 11:50:24
```

The second line of output is highlighted with a red box. At the bottom of the terminal, there is a status bar with "RUNNING" and "DEM1ZVM" on the right, and "MA b" and "31 / 001" on the left. The status bar also indicates "Connected to remote server/host 9.39.68.141 using port 23".

```

Session B - TSTADMN1 - [32 x 80]
File Edit View Communication Actions Window Help
0112 PEEK A0 V 204 Trunc=204 Size=4037 Line=0 Col=1 Alt=0
File VIEWCON DIRMAINT from OPMGRM1 at DEM1ZVM Format is PRINT.
*** Top of File ***
DIRMAINT DEM1ZVM. - 2010/09/24; T=0.01/0.01 06:56:02
DVHWAI2140I Waiting for work on 10/09/24 at 06:56:02.
DVHWAI2143I Wakeup caused by timer file entry on 10/09/24 at 07:01:01.
DVHWAI2143I Processing event number 00005 scheduled for ==/==/== at
DVHWAI2143I +01:00:0.
DIRMAINT DEM1ZVM. - 2010/09/24; T=0.01/0.01 07:01:01
DVHREQ2290I Request is: CMS EXEC DVHOURLY
DVHREQ2288I Your CMS request for DIRMAINT at * has been accepted.
DVHRLY3886I Hourly processing started; with 0 log
DVHRLY3886I files.
DVHREQ2289I Your CMS request for DIRMAINT at * has completed; with RC
DVHREQ2289I = 0.
DIRMAINT DEM1ZVM. - 2010/09/24; T=0.02/0.02 07:01:02
DVHWAI2140I Waiting for work on 10/09/24 at 07:01:02.
DVHWAI2142I Wakeup caused by elapsed time on 10/09/24 at 07:06:02.
DIRMAINT DEM1ZVM. - 2010/09/24; T=0.01/0.01 07:06:02
DVHWAI2140I Waiting for work on 10/09/24 at 07:06:02.
DVHWAI2142I Wakeup caused by elapsed time on 10/09/24 at 07:11:02.
DIRMAINT DEM1ZVM. - 2010/09/24; T=0.01/0.01 07:11:02
DVHWAI2140I Waiting for work on 10/09/24 at 07:11:02.
DVHWAI2142I Wakeup caused by elapsed time on 10/09/24 at 07:16:02.
DIRMAINT DEM1ZVM. - 2010/09/24; T=0.01/0.01 07:16:02
DVHWAI2140I Waiting for work on 10/09/24 at 07:16:02.
DVHWAI2142I Wakeup caused by elapsed time on 10/09/24 at 07:21:02.
1= Help      2= Add line  3= Quit      4= Tab       5= Clocate   6= ?/Change
7= Backward  8= Forward   9= Receive  10= Rgtright 11= Spltjoin 12= Cursor

====> -
X E D I T 1 File
MA b 31/007
Connected to remote server/host 9.39.68.141 using port 23

```

Scenario 6: How Do You Do That?

Console rule and action in Operations Manager:

```
DEFRULE NAME(DIRMLOG) , +  
  MATCH( *DVHRLY3895*01AA* ) , +  
  USER(DIRMAINT) , +  
  ACTION(DIRMLOG)
```

*

```
DEFACTN NAME(DIRMLOG) , +  
  INPUT(AHI) , +  
  NEXTACTN(DIRMLOGB)
```

*

```
DEFACTN NAME(DIRMLOGB) , +  
  COMMAND(EXEC DIRM1AA &U) , +  
  ENV(LVM)
```

Authorize Operations Manager to issue DIRM SHUTDOWN – from MAINT issue

```
DIRM AUTHFOR OPMGRM1 CMDLEVEL 150A CMDSET 0
```

Scenario 6: How Do You Do That?

DIRM1AA EXEC (excerpts):

```
Parse Upper Arg Tuser . ;
/* Try to shut DIRMAINT down. */
Say 'DIRM1AA - Issuing DIRM SHUTDOWN ....';
Address CMS 'DIRM SHUTDOWN';

Address Command 'CP LINK' Tuser '1AA' Dev 'MR';
Address CMS 'ACCESS' Dev Fm;

Address Command 'PIPE CMS LISTFILE DIRMAINT *LOG*' Fm '( NOHEADER',
  '| STEM FILES.';
Do I = 1 to Files.0;
  Parse Upper Var Files.I Fn Ft .;
  Address CMS 'SENDFILE' Fn Ft Fm 'TO ARCHLOGS';
  If Rc = 0 then Do;
    Sent = Sent+1;
    Address CMS 'ERASE' Fn Ft Fm;
  End
Address Command 'CP XAUTOLOG' Tuser;
```

Scenario 7: Process a File of Test Messages as a Console

- **Create a file containing lines of test messages**
 - Test rules and actions without creating critical conditions
- **Use Operations Manager to send the file for processing**
 - Treat it as the console of one user
 - Send it again treating it as the console of another user
 - Notice triggered rules and actions are different
- **View the “consoles” of these two users**

Scenario 7: Detailed Steps

- **Create or view a file of test messages**

```
xedit test consdata a
```

- Notice the “hello” message in the file

- **From a z/VM user ID, send the test file to Operations Manager**

- Send it twice, specifying two different “owning” user IDs. One generates a message and one doesn’t:

```
gomrsif test consdata a 9.39.64.72 63000 tstadm8
```

```
gomrsif test consdata a 9.39.64.72 63000 tstuser8
```

- **From an authorized z/VM user ID, view the consoles of the owning user IDs:**

```
gomcmd opmgrm1 viewcon user(tstadm8)
```

```
gomcmd opmgrm1 viewcon user(tstuser8)
```



```
Session B - TSTADMN1 - [32 x 80]
File Edit View Communication Actions Window Help
TEST CONSDATA A1 F 80 Trunc=80 Size=5 Line=0 Col=1 Alt=0
====>
T...+...1...+...2...+...3...+...4...+...5...+...6...+...7...
00000 * * * Top of File * * *
00001 hello there from remote system input
00002 here is another critical system message
00003 warning message to test
00004 junk
00005 noise
00006 * * * End of File * * *
MA b 02/007
Connected to remote server/host 9.39.68.141 using port 23
```

```
Session B - TSTADMN1 - [32 x 80]
File Edit View Communication Actions Window Help
Ready; T=0.01/0.01 13:39:15
gomsif test consdata a 9.39.68.141 63000 tstadm8
Connecting to 9.39.68.141
Sending TEST CONSDATA A to 9.39.68.141
13:39:12 * MSG FROM OPMGRM1 : HELLO BACK FROM TSTADMN8.
Ready; T=0.01/0.01 13:39:12
gomsif test consdata a 9.39.68.141 63000 tstuser8
Connecting to 9.39.68.141
Sending TEST CONSDATA A to 9.39.68.141
Ready; T=0.01/0.01 13:39:18

RUNNING DEM1ZVM
MA b 31/001
Connected to remote server/host 9.39.68.141 using port 23
```

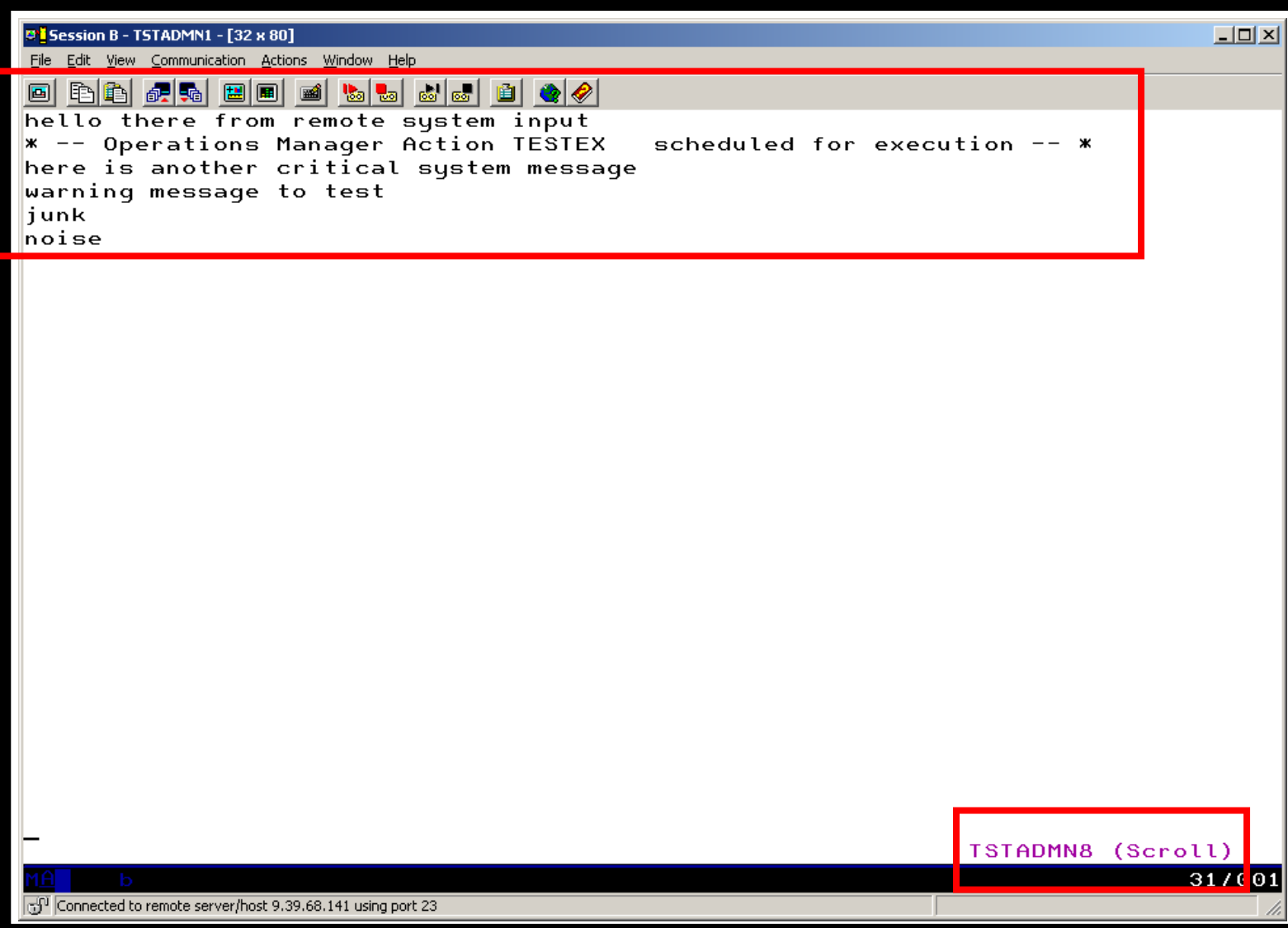

```
Session B - TSTADMN1 - [32 x 80]
File Edit View Communication Actions Window Help
hello there from remote system input
* -- Operations Manager Action TESTEX  scheduled for execution -- *
here is another critical system message
warning message to test
junk
noise

TSTADMN8 (Scroll)
31/001
Connected to remote server/host 9.39.68.141 using port 23
```

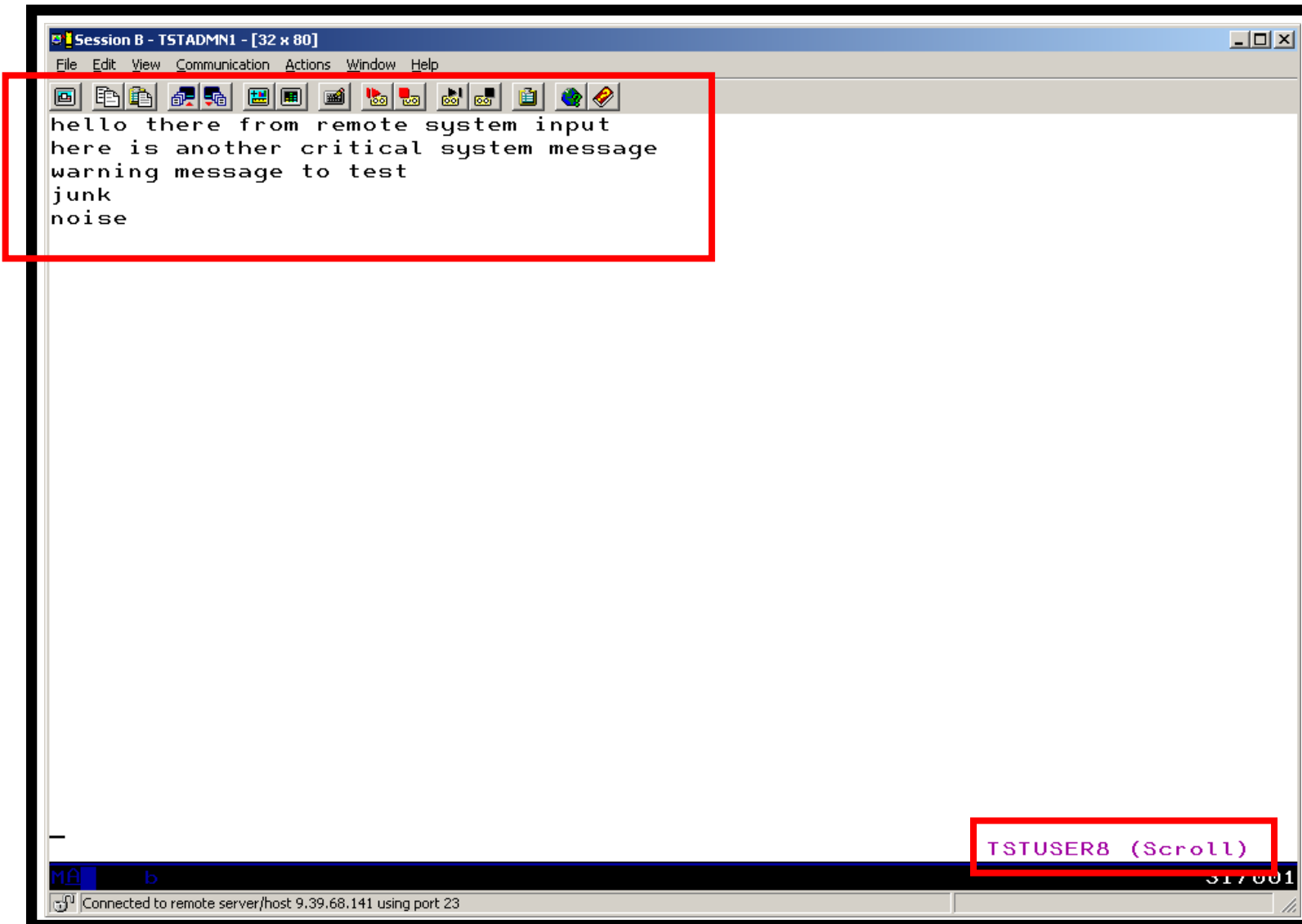

Scenario 7: How Do You Do That?

Console rule and action in Operations Manager:

*

```
DEFRULE NAME (TESTEX) , +  
  MATCH ( *HELLO* ) , +  
  MCOL ( 001 : 030 ) , +  
  ACTION ( TESTEX ) , +  
  EXGROUP ( TSTUSERS )
```

*

```
DEFACTN NAME ( TESTEX ) , +  
  COMMAND ( CP MSG TSTADMIN1 HELLO BACK FROM &U. ) , +  
  OUTPUT ( LOG ) , +  
  ENV ( LVM )
```

Scenario 7: How Do You Do That?

Set up TCP/IP listener for test data and define group of consoles:

*

```
DEFTCPA NAME (TESTDATA) , +  
    TCPUSER (TCPIP) , +  
    TCPAPPL (GOMRSIF) , +  
    TCPADDR (000.000.000.000) , +  
    TCPPORT (63000)
```

*

```
DEFGROUP NAME (TSTUSERS) , +  
    USER (TSTUSER*)
```

Update TCP/IP configuration to allow Operations Manager to listen on the specified port

Scenario 8: Process Linux Syslog Data as a Console

- **Route syslog data from a Linux guest to Operations Manager for z/VM**
 - Supports syslogd, syslog-ng, rsyslog
 - syslog-ng and rsyslog include hostname or IP address in message
- **Treat it as the console of a “fake” user ID**
- **Trigger rules and actions based on syslog data**
- **View the “console” containing syslog data**
- **Option to create one console per syslog or combine multiple syslogs into one console**

Scenario 8: Detailed Steps

- **From an authorized z/VM user ID, view any syslog data already received**

```
gomcmd opmgrm1 viewcon user(lxsyslog)
```

- **Use PUTTY to connect to a Linux guest**
- **Login as root and issue the command**

```
logger here is a critical test message from SHARE
```

- **Return to the VIEWCON session**
 - See the message in the syslog “console”
 - Using syslog, so no hostname or IP address
- **Repeat from a different Linux guest that uses syslog-ng**

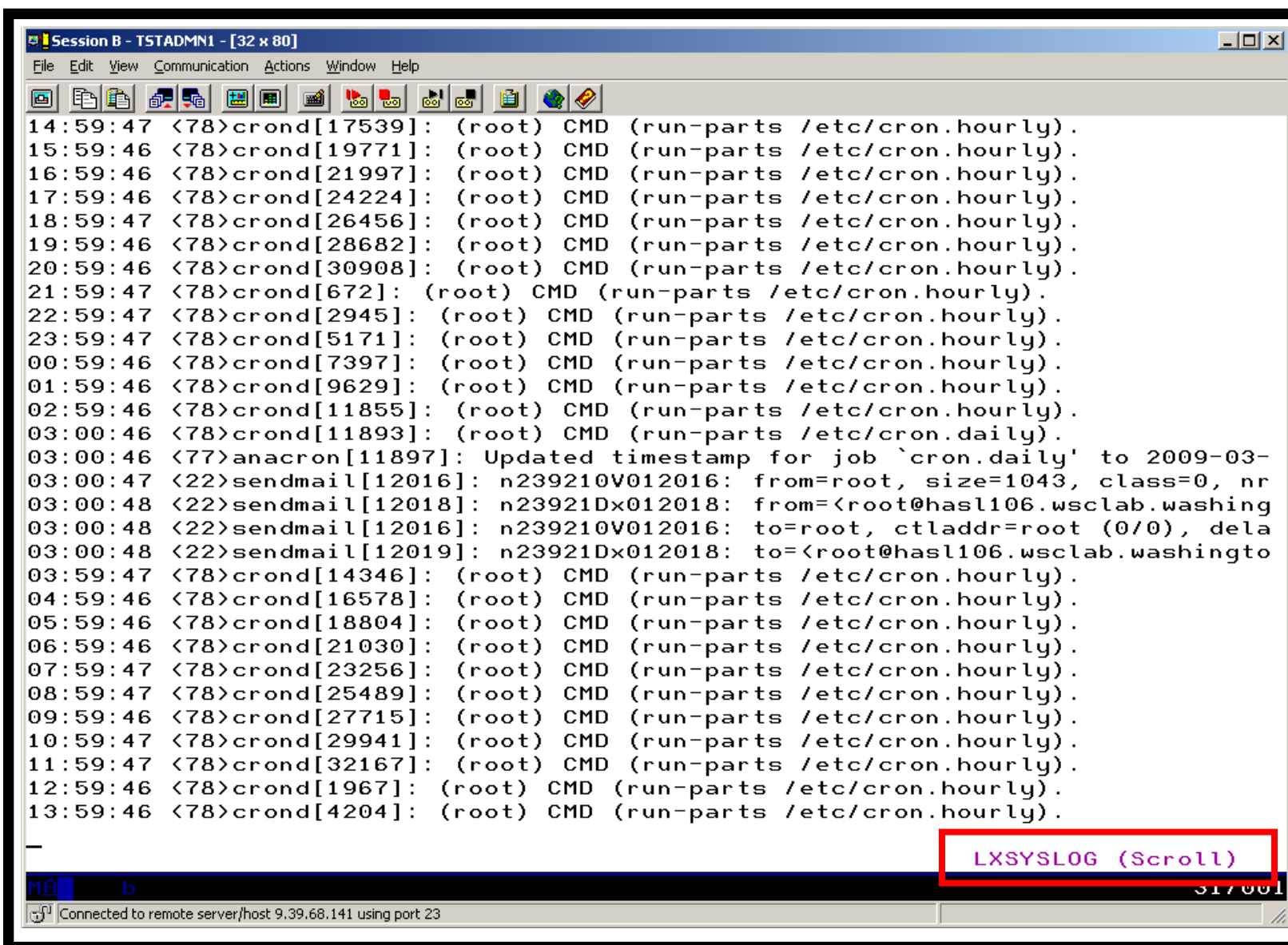

```
Session B - TSTADMIN1 - [32 x 80]
File Edit View Communication Actions Window Help
14:59:47 <78>crond[17539]: (root) CMD (run-parts /etc/cron.hourly).
15:59:46 <78>crond[19771]: (root) CMD (run-parts /etc/cron.hourly).
16:59:46 <78>crond[21997]: (root) CMD (run-parts /etc/cron.hourly).
17:59:46 <78>crond[24224]: (root) CMD (run-parts /etc/cron.hourly).
18:59:47 <78>crond[26456]: (root) CMD (run-parts /etc/cron.hourly).
19:59:46 <78>crond[28682]: (root) CMD (run-parts /etc/cron.hourly).
20:59:46 <78>crond[30908]: (root) CMD (run-parts /etc/cron.hourly).
21:59:47 <78>crond[672]: (root) CMD (run-parts /etc/cron.hourly).
22:59:47 <78>crond[2945]: (root) CMD (run-parts /etc/cron.hourly).
23:59:47 <78>crond[5171]: (root) CMD (run-parts /etc/cron.hourly).
00:59:46 <78>crond[7397]: (root) CMD (run-parts /etc/cron.hourly).
01:59:46 <78>crond[9629]: (root) CMD (run-parts /etc/cron.hourly).
02:59:46 <78>crond[11855]: (root) CMD (run-parts /etc/cron.hourly).
03:00:46 <78>crond[11893]: (root) CMD (run-parts /etc/cron.daily).
03:00:46 <77>anacron[11897]: Updated timestamp for job `cron.daily' to 2009-03-
03:00:47 <22>sendmail[12016]: n239210V012016: from=root, size=1043, class=0, nr
03:00:48 <22>sendmail[12018]: n23921Dx012018: from=<root@hasl106.wsclab.washing
03:00:48 <22>sendmail[12016]: n239210V012016: to=root, ctladdr=root (0/0), dela
03:00:48 <22>sendmail[12019]: n23921Dx012018: to=<root@hasl106.wsclab.washingto
03:59:47 <78>crond[14346]: (root) CMD (run-parts /etc/cron.hourly).
04:59:46 <78>crond[16578]: (root) CMD (run-parts /etc/cron.hourly).
05:59:46 <78>crond[18804]: (root) CMD (run-parts /etc/cron.hourly).
06:59:46 <78>crond[21030]: (root) CMD (run-parts /etc/cron.hourly).
07:59:47 <78>crond[23256]: (root) CMD (run-parts /etc/cron.hourly).
08:59:47 <78>crond[25489]: (root) CMD (run-parts /etc/cron.hourly).
09:59:46 <78>crond[27715]: (root) CMD (run-parts /etc/cron.hourly).
10:59:47 <78>crond[29941]: (root) CMD (run-parts /etc/cron.hourly).
11:59:47 <78>crond[32167]: (root) CMD (run-parts /etc/cron.hourly).
12:59:46 <78>crond[1967]: (root) CMD (run-parts /etc/cron.hourly).
13:59:46 <78>crond[4204]: (root) CMD (run-parts /etc/cron.hourly).
-
LXSYSLOG (Scroll)
317001
Connected to remote server/host 9.39.68.141 using port 23
```

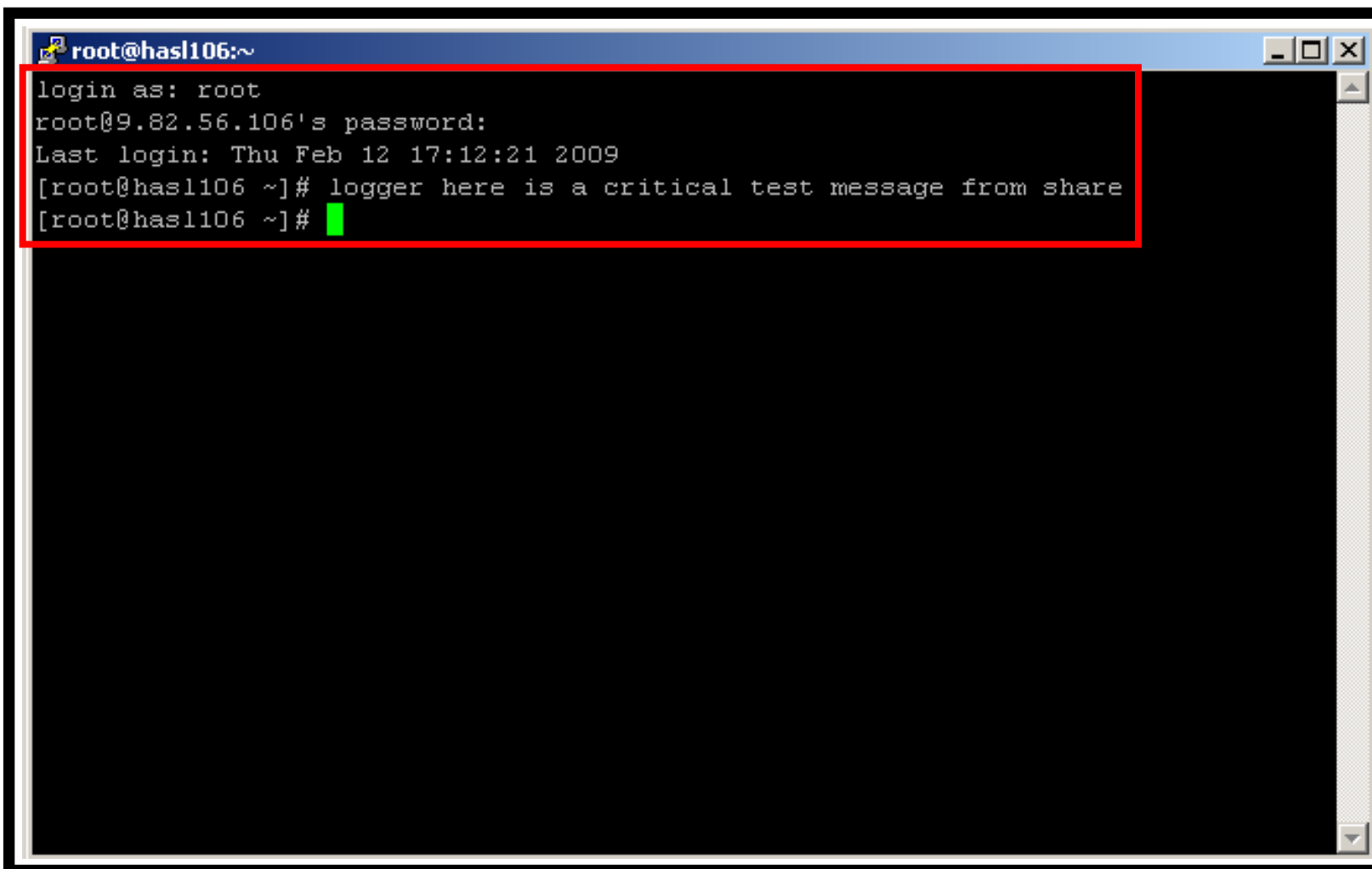

```
root@has1106:~  
login as: root  
root@9.82.56.106's password:  
Last login: Thu Feb 12 17:12:21 2009  
[root@has1106 ~]# logger here is a critical test message from share  
[root@has1106 ~]# █
```

```
Session B - TSTADMIN1 - [32 x 80]
File Edit View Communication Actions Window Help
18:59:47 <78>crond[26456]: (root) CMD (run-parts /etc/cron.hourly).
19:59:46 <78>crond[28682]: (root) CMD (run-parts /etc/cron.hourly).
20:59:46 <78>crond[30908]: (root) CMD (run-parts /etc/cron.hourly).
21:59:47 <78>crond[672]: (root) CMD (run-parts /etc/cron.hourly).
22:59:47 <78>crond[2945]: (root) CMD (run-parts /etc/cron.hourly).
23:59:47 <78>crond[5171]: (root) CMD (run-parts /etc/cron.hourly).
00:59:46 <78>crond[7397]: (root) CMD (run-parts /etc/cron.hourly).
01:59:46 <78>crond[9629]: (root) CMD (run-parts /etc/cron.hourly).
02:59:46 <78>crond[11855]: (root) CMD (run-parts /etc/cron.hourly).
03:00:46 <78>crond[11893]: (root) CMD (run-parts /etc/cron.daily).
03:00:46 <77>anacron[11897]: Updated timestamp for job `cron.daily' to 2009-03-
03:00:47 <22>sendmail[12016]: n239210V012016: from=root, size=1043, class=0, nr
03:00:48 <22>sendmail[12018]: n23921Dx012018: from=<root@hasl106.wsclab.washing
03:00:48 <22>sendmail[12016]: n239210V012016: to=root, ctladdr=root (0/0), dela
03:00:48 <22>sendmail[12019]: n23921Dx012018: to=<root@hasl106.wsclab.washingto
03:59:47 <78>crond[14346]: (root) CMD (run-parts /etc/cron.hourly).
04:59:46 <78>crond[16578]: (root) CMD (run-parts /etc/cron.hourly).
05:59:46 <78>crond[18804]: (root) CMD (run-parts /etc/cron.hourly).
06:59:46 <78>crond[21030]: (root) CMD (run-parts /etc/cron.hourly).
07:59:47 <78>crond[23256]: (root) CMD (run-parts /etc/cron.hourly).
08:59:47 <78>crond[25489]: (root) CMD (run-parts /etc/cron.hourly).
09:59:46 <78>crond[27715]: (root) CMD (run-parts /etc/cron.hourly).
10:59:47 <78>crond[29941]: (root) CMD (run-parts /etc/cron.hourly).
11:59:47 <78>crond[32167]: (root) CMD (run-parts /etc/cron.hourly).
12:59:46 <78>crond[1967]: (root) CMD (run-parts /etc/cron.hourly).
13:59:46 <78>crond[4204]: (root) CMD (run-parts /etc/cron.hourly).
14:14:13 <86>sshd[4731]: Accepted password for root from 9.49.128.169 port 2403
14:14:13 <86>sshd[4731]: pam_unix(sshd:session): session opened for user root b
14:14:58 <13>root: here is a critical test message from share.
14:14:58 * -- Operations Manager Action LXLOG scheduled for execution -- *
-
LXSYSLOG (Scroll)
MA b 317001
Connected to remote server/host 9.39.68.141 using port 23
```

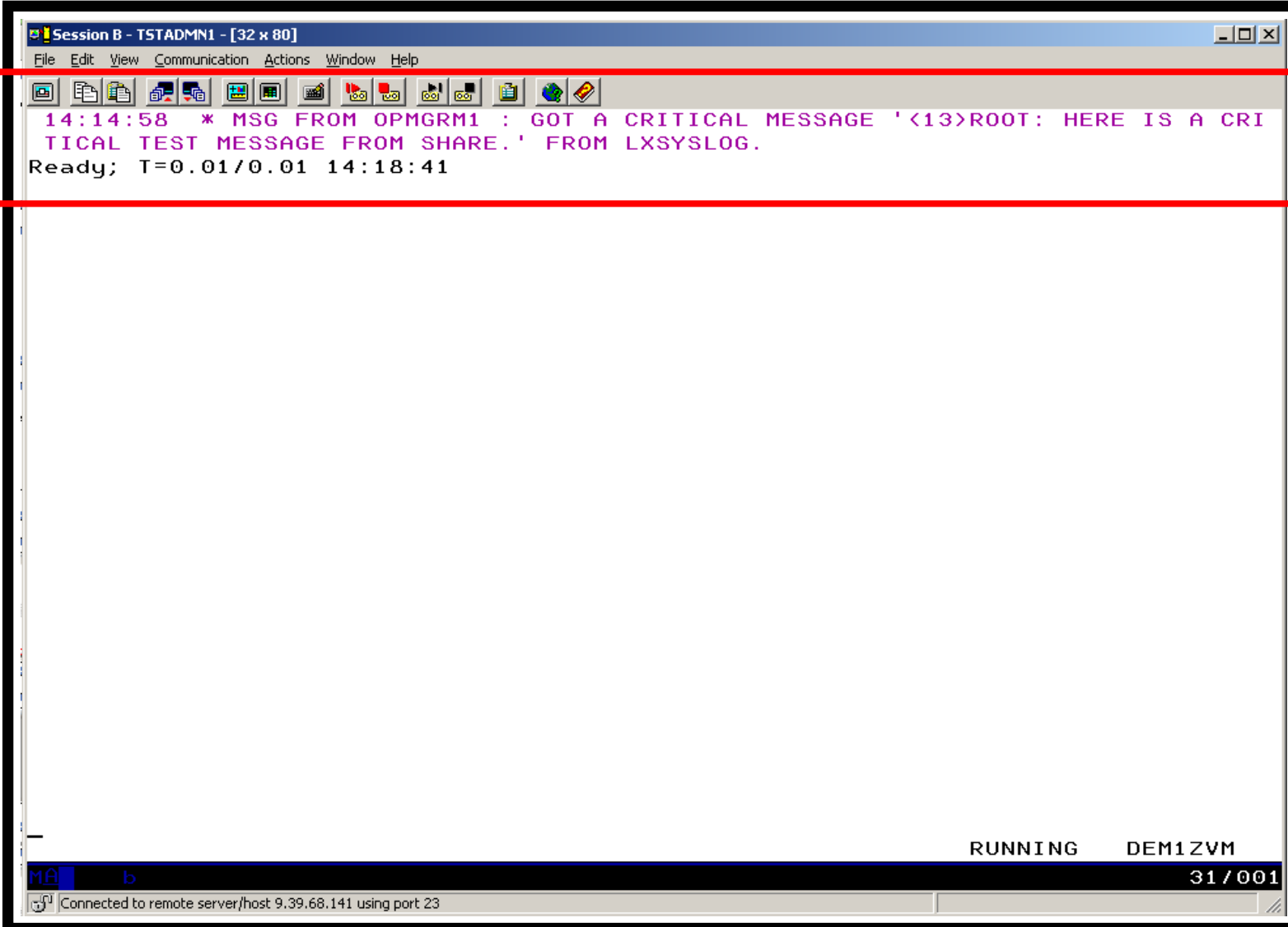

The screenshot shows a terminal window titled "Session B - TSTADMIN1 - [32 x 80]". The window has a menu bar with "File", "Edit", "View", "Communication", "Actions", "Window", and "Help". Below the menu bar is a toolbar with various icons. The main content area displays the following text:

```
14:14:58 * MSG FROM OPMGRM1 : GOT A CRITICAL MESSAGE '<13>ROOT: HERE IS A CRI  
TICAL TEST MESSAGE FROM SHARE.' FROM LXSYSLOG.  
Ready; T=0.01/0.01 14:18:41
```

The text is highlighted with a red rectangular box. At the bottom of the terminal window, there is a status bar with the text "RUNNING DEM1ZVM" and "31/001". The bottom-most part of the window shows a connection status: "Connected to remote server/host 9.39.68.141 using port 23".

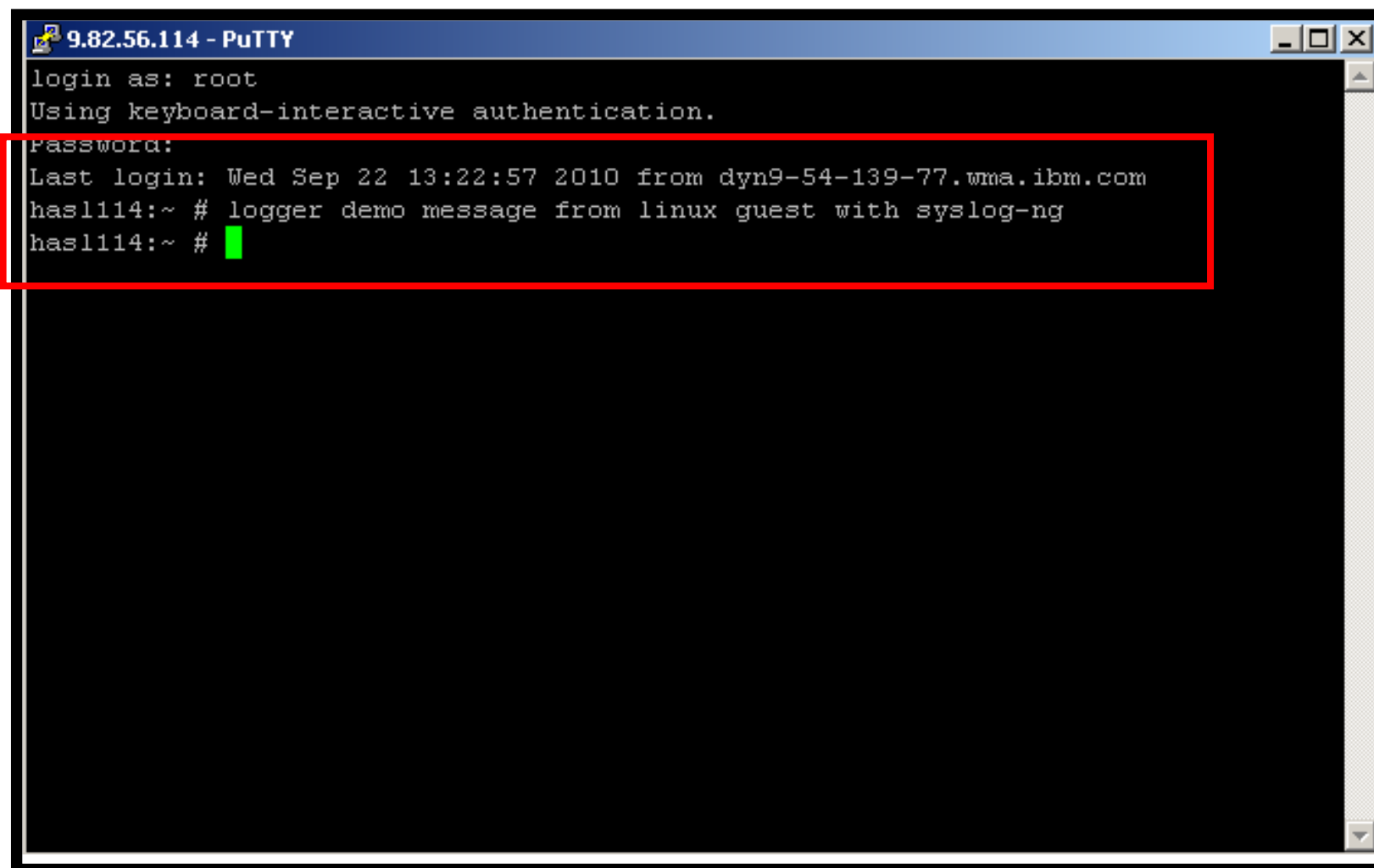

The image shows a PuTTY terminal window titled "9.82.56.114 - PuTTY". The terminal output is as follows:

```
login as: root
Using keyboard-interactive authentication.
Password:
Last login: Wed Sep 22 13:22:57 2010 from dyn9-54-139-77.wma.ibm.com
has114:~ # logger demo message from linux guest with syslog-ng
has114:~ # █
```

A red rectangular box highlights the lines from "Password:" to the second prompt "has114:~ # █".

```
Session A - TSTADMN1 - [32 x 80]
File Edit View Communication Actions Window Help
<46>Oct 27 13:16:08 omeqlnx1 -- MARK --.
<46>Oct 27 13:16:08 omeqlnx1 syslog-ng[1301]: Log statistics; dropped='pipe(/de
<46>Oct 27 13:36:08 omeqlnx1 -- MARK --.
<45>Oct 27 14:43:49 hasl114 syslog-ng[1433]: STATS: dropped 0.
<46>Oct 27 13:56:08 omeqlnx1 -- MARK --.
<46>Oct 27 14:16:08 omeqlnx1 -- MARK --.
<46>Oct 27 14:16:08 omeqlnx1 syslog-ng[1301]: Log statistics; dropped='pipe(/de
<46>Oct 27 14:36:08 omeqlnx1 -- MARK --.
<35>Oct 27 15:42:44 hasl114 sshd[7320]: error: PAM: Authentication failure for
<45>Oct 27 15:43:49 hasl114 syslog-ng[1433]: STATS: dropped 1.
<34>Oct 27 15:44:38 hasl114 sshd[7320]: fatal: Timeout before authentication fo
* -- Operations Manager Action MSGOPER8 scheduled for execution -- *
<83>Oct 27 15:44:38 hasl114 sshd[7323]: pam_unix2(sshd:auth): conversation fail
<35>Oct 27 15:44:38 hasl114 sshd[7323]: error: ssh_msg_send: write.
<46>Oct 27 14:56:08 omeqlnx1 -- MARK --.
<46>Oct 27 15:16:08 omeqlnx1 -- MARK --.
<46>Oct 27 15:16:08 omeqlnx1 syslog-ng[1301]: Log statistics; dropped='pipe(/de
<46>Oct 27 15:36:08 omeqlnx1 -- MARK --.
<45>Oct 27 16:43:49 hasl114 syslog-ng[1433]: STATS: dropped 1.
<46>Oct 27 15:56:08 omeqlnx1 -- MARK --.
<46>Oct 27 16:16:08 omeqlnx1 -- MARK --.
<46>Oct 27 16:16:08 omeqlnx1 syslog-ng[1301]: Log statistics; dropped='pipe(/de
<46>Oct 27 16:36:08 omeqlnx1 -- MARK --.
<45>Oct 27 17:43:49 hasl114 syslog-ng[1433]: STATS: dropped 0.
<46>Oct 27 16:56:08 omeqlnx1 -- MARK --.
<46>Oct 27 17:16:08 omeqlnx1 -- MARK --.
<46>Oct 27 17:16:08 omeqlnx1 syslog-ng[1301]: Log statistics; dropped='pipe(/de
<46>Oct 27 17:36:08 omeqlnx1 -- MARK --.
<38>Oct 27 18:32:17 hasl114 sshd[8168]: Accepted keyboard-interactive/pam for r
<13>Oct 27 18:32:35 hasl114 root: demo message from linux guest with syslog-ng.
-
MB a
317001
Connected to remote server/host 9.39.68.141 using port 23
```

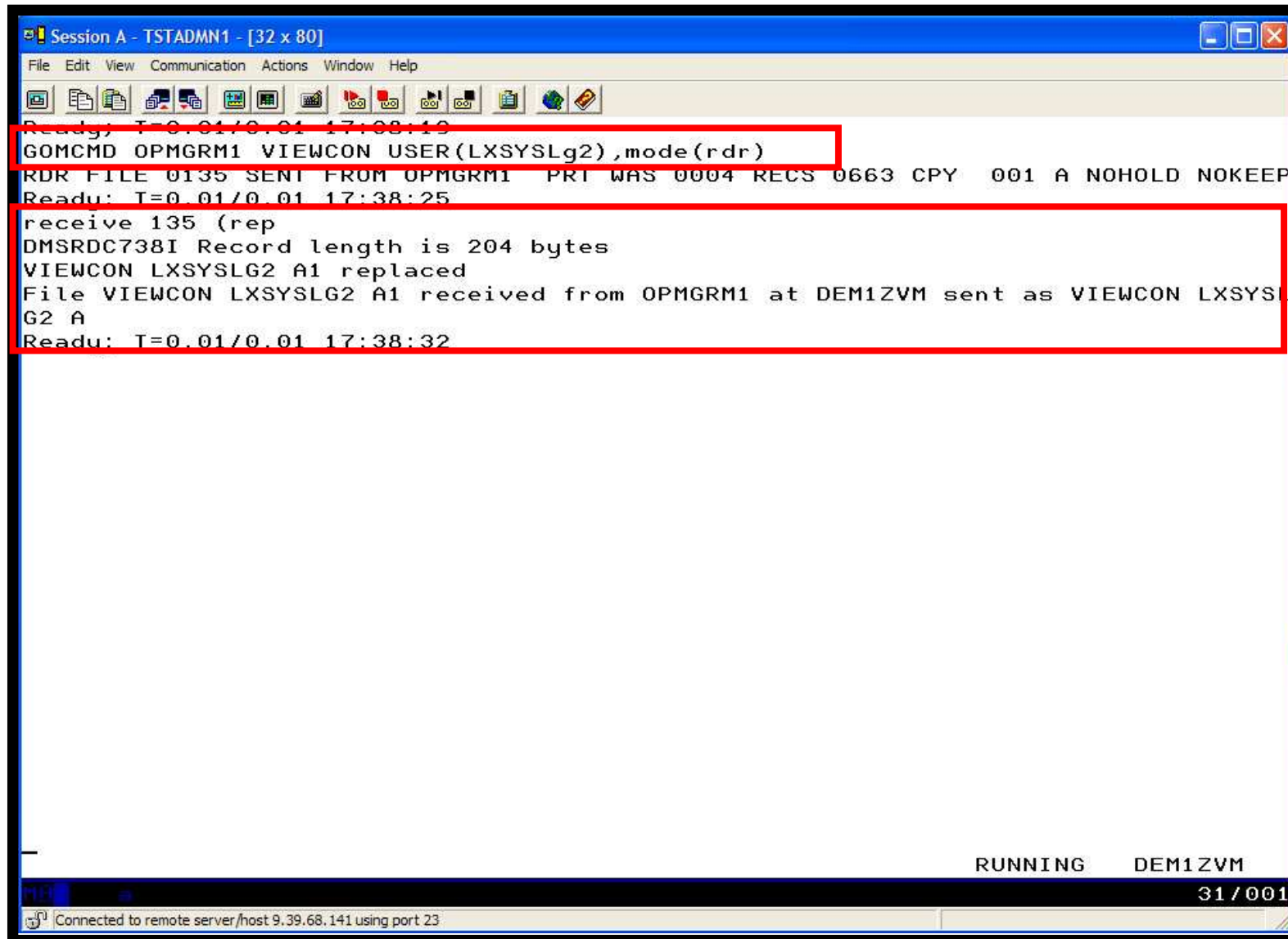

```
Session A - TSTADMN1 - [32 x 80]
File Edit View Communication Actions Window Help
Ready: T=0.01/0.01 17:08:19
GOMCMD OPMGRM1 VIEWCON USER(LXSYSLG2),mode(rdr)
RDR FILE 0135 SENT FROM OPMGRM1 PRT WAS 0004 RECS 0663 CPY 001 A NOHOLD NOKEEP
Ready: T=0.01/0.01 17:38:25
receive 135 (rep
DMSRDC738I Record length is 204 bytes
VIEWCON LXSYSLG2 A1 replaced
File VIEWCON LXSYSLG2 A1 received from OPMGRM1 at DEM1ZVM sent as VIEWCON LXSYS
G2 A
Ready: T=0.01/0.01 17:38:32

RUNNING DEM1ZVM
31 / 001
Connected to remote server/host 9.39.68.141 using port 23
```

```

Session A - TSTADMN1 - [32 x 80]
File Edit View Communication Actions Window Help
VIEWCON LXSYSLG2 A1 F 204 Trunc=204 Size=663 Line=0 Col=1 Alt=0
====>
T...+...1...+...2...+...3...+...4...+...5...+...6...+...7..

==== * * * Top of File * * *
==== 10/22/2010 11:39:59 <43>Oct 22 12:34:53 hasl114 syslog-ng[1433]: Connect
==== 10/22/2010 11:47:31 <45>Oct 22 12:43:25 hasl114 syslog-ng[1433]: STATS:
==== 10/22/2010 11:57:08 <46>Oct 22 11:56:07 omeglnx1 -- MARK --.
==== 10/22/2010 11:57:08 <43>Oct 22 11:56:07 omeglnx1 syslog-ng[1301]: I/O er
==== 10/22/2010 11:57:08 <43>Oct 22 11:56:07 omeglnx1 syslog-ng[1301]: Connec
==== 10/22/2010 12:05:21 <12>Oct 22 13:01:15 hasl114 zmd: ShutdownManager (WA
==== 10/22/2010 12:05:21 <12>Oct 22 13:01:15 hasl114 zmd: ShutdownManager (WA
==== 10/22/2010 12:16:08 <46>Oct 22 12:16:07 omeglnx1 -- MARK --.
==== 10/22/2010 12:16:08 <46>Oct 22 12:16:07 omeglnx1 syslog-ng[1301]: Log st
==== 10/22/2010 12:36:08 <46>Oct 22 12:36:07 omeglnx1 -- MARK --.
==== 10/22/2010 12:47:31 <45>Oct 22 13:43:25 hasl114 syslog-ng[1433]: STATS:
==== 10/22/2010 12:56:08 <46>Oct 22 12:56:07 omeglnx1 -- MARK --.
==== 10/22/2010 13:16:08 <46>Oct 22 13:16:07 omeglnx1 -- MARK --.
==== 10/22/2010 13:16:08 <46>Oct 22 13:16:07 omeglnx1 syslog-ng[1301]: Log st
==== 10/22/2010 13:36:08 <46>Oct 22 13:36:07 omeglnx1 -- MARK --.
==== 10/22/2010 13:47:31 <45>Oct 22 14:43:25 hasl114 syslog-ng[1433]: STATS:
==== 10/22/2010 13:56:08 <46>Oct 22 13:56:07 omeglnx1 -- MARK --.
==== 10/22/2010 14:16:08 <46>Oct 22 14:16:07 omeglnx1 -- MARK --.
==== 10/22/2010 14:16:08 <46>Oct 22 14:16:07 omeglnx1 syslog-ng[1301]: Log st
==== 10/22/2010 14:36:08 <46>Oct 22 14:36:07 omeglnx1 -- MARK --.
==== 10/22/2010 14:47:31 <45>Oct 22 15:43:25 hasl114 syslog-ng[1433]: STATS:
==== 10/22/2010 14:56:08 <46>Oct 22 14:56:07 omeglnx1 -- MARK --.
==== 10/22/2010 15:16:08 <46>Oct 22 15:16:07 omeglnx1 -- MARK --.
==== 10/22/2010 15:16:08 <46>Oct 22 15:16:07 omeglnx1 syslog-ng[1301]: Log st
==== 10/22/2010 15:36:08 <46>Oct 22 15:36:07 omeglnx1 -- MARK --.
==== 10/22/2010 15:47:31 <45>Oct 22 16:43:26 hasl114 syslog-ng[1433]: STATS:

```

MA a 02/007

Connected to remote server/host 9.39.68.141 using port 23

Scenario 8: How Do You Do That?

Console rule and action in Operations Manager:

*

```
DEFRULE NAME(LXLOG),+  
  MATCH(*critical test message*),+  
  ACTION(LXLOG),+  
  USER(LXSYSLOG)
```

*

```
DEFACTN NAME(LXLOG),+  
  COMMAND(CP MSG TSTADMIN1 Got a critical message '&T' from &U.),+  
  OUTPUT(LOG),+  
  ENV(LVM)
```

Scenario 8: How Do You Do That?

- **Set up TCP/IP listener for syslog data**

*

```
DEFTCPA NAME(LNXSYSLG),+  
  TCPUSER(TCPIP),+  
  TCPAPPL(GOMRSYL),+  
  TCPADDR(000.000.000.000),+  
  TCPPORT(00514),+  
  PARM(LXSYSLOG03330417UTF8)
```

*

```
DEFTCPA NAME(LNXSYSL2),+  
  TCPUSER(TCPIP),+  
  TCPAPPL(GOMRSYL),+  
  TCPADDR(000.000.000.000),+  
  TCPPORT(00515),+  
  PARM(LXSYSLG203330417UTF8)
```

- **Update TCP/IP configuration to allow Operations Manager to listen for UDP traffic on the specified port(s)**
 - Ports 514 and 515 used here
- **Update the Linux guest to send its syslog data to the IP address and port of your z/VM system**

Scenario 9: Create a Central Operations Console on One z/VM System

- **Use Operations Manager to watch for error, warning, fatal messages on service machine consoles**
 - DIRMAINT, TCP/IP, RACF, etc.
 - Linux guests
 - Linux syslog
- **Route these messages to a central operations console**
- **Operations staff watches operations console for signs of trouble**
 - View individual service machine consoles for more details when needed

Creating a Central Console on One z/VM System

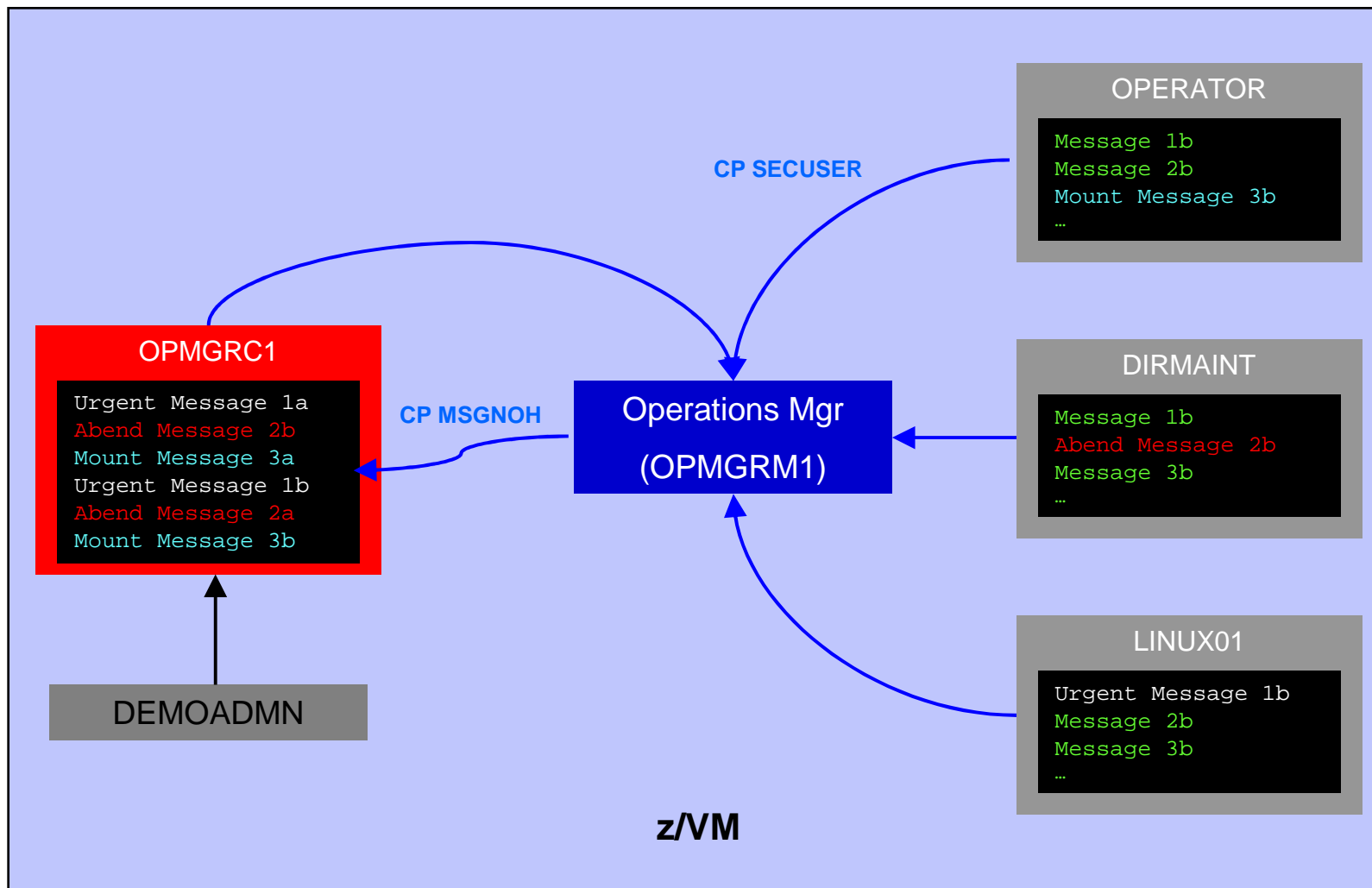

Scenario 9: Detailed Steps

- From an authorized z/VM user ID, put “abend”, “fatal”, and error messages on DIRMAINT console

```
msgnoh dirmaint this is a test abend message
```

```
msgnoh dirmaint this is a fake fatal message
```

```
msgnoh dirmaint DMSxxxxxxxxxE here is a made-up CMS error msg
```

- View the “Operations Console” to see the messages

```
gomcmd opmgrm1 viewcon user(oper8)
```

- Note the fatal message is red and abend message is highlighted and will be held when other messages come in

Scenario 9: Detailed Steps

- **From another user ID, run an EXEC to send multiple messages to the Operations Console**

```
lotsmsgs
```

- **View the “Operations Console” to see the messages**

```
gomcmd opmgrm1 viewcon user(oper8)
```

- **Watch the scrolling, held messages, etc.**

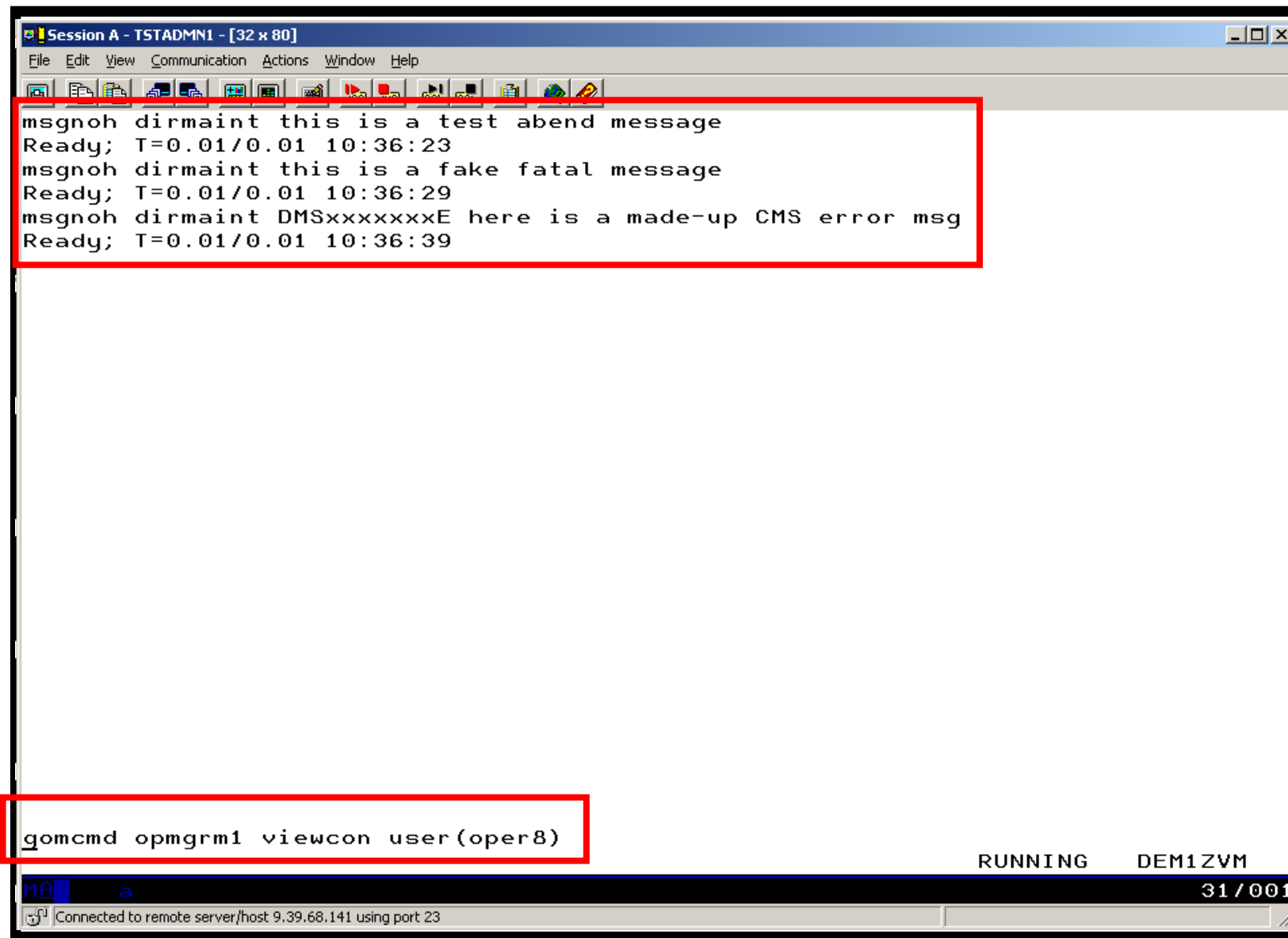

```
Session A - TSTADMN1 - [32 x 80]
File Edit View Communication Actions Window Help
msgnoh dirmaint this is a test abend message
Ready; T=0.01/0.01 10:36:23
msgnoh dirmaint this is a fake fatal message
Ready; T=0.01/0.01 10:36:29
msgnoh dirmaint DMSxxxxxxxE here is a made-up CMS error msg
Ready; T=0.01/0.01 10:36:39

gomcmd opmgrm1 viewcon user(oper8)

RUNNING DEM1ZVM
31/001
Connected to remote server/host 9.39.68.141 using port 23
```

```
Session A - TSTADMIN1 - [32 x 80]
File Edit View Communication Actions Window Help
11:54:03 A FAKE ABEND HAS OCCURRED
14:13:50 A fake abend has occurred
14:14:32 This is standard non scary message 17
14:14:33 This is standard non scary message 18
14:14:34 This is standard non scary message 19
14:14:35 This is standard non scary message 20
14:14:36 This is standard non scary message 21
14:14:37 This is standard non scary message 22
14:14:38 This is standard non scary message 23
14:14:39 This is standard non scary message 24
14:14:39 This is standard non scary message 25
14:14:41 This is standard non scary message 26
14:14:42 This is standard non scary message 27
14:14:42 This is standard non scary message 28
14:14:43 This is standard non scary message 29
14:14:44 This is standard non scary message 30
14:14:46 This is standard non scary message 31
14:14:47 This is standard non scary message 32
14:14:48 This is standard non scary message 33
14:14:49 This is standard non scary message 34
14:14:50 This is standard non scary message 35
17:39:47 DIRMAINT : TEST MESSAGE WITH FATAL TEXT
17:40:26 DIRMAINT : TEST MESSAGE WITH ABEND TEXT
00:00:00 HCPMID6001I  TIME IS 00:00:00 CDT FRIDAY 10/02/09
00:00:00
23:59:59 HCPMID6001I  TIME IS 00:00:00 CDT SATURDAY 10/03/09
23:59:59
10:36:23 DIRMAINT : THIS IS A TEST ABEND MESSAGE
10:36:28 DIRMAINT : THIS IS A FAKE FATAL MESSAGE
10:36:39 DIRMAINT : DMSXXXXXXXXE HERE IS A MADE-UP CMS ERROR MSG
-
OPER8 (Scroll)
MA a 31 / 001
Connected to remote server/host 9.39.68.141 using port 23
```

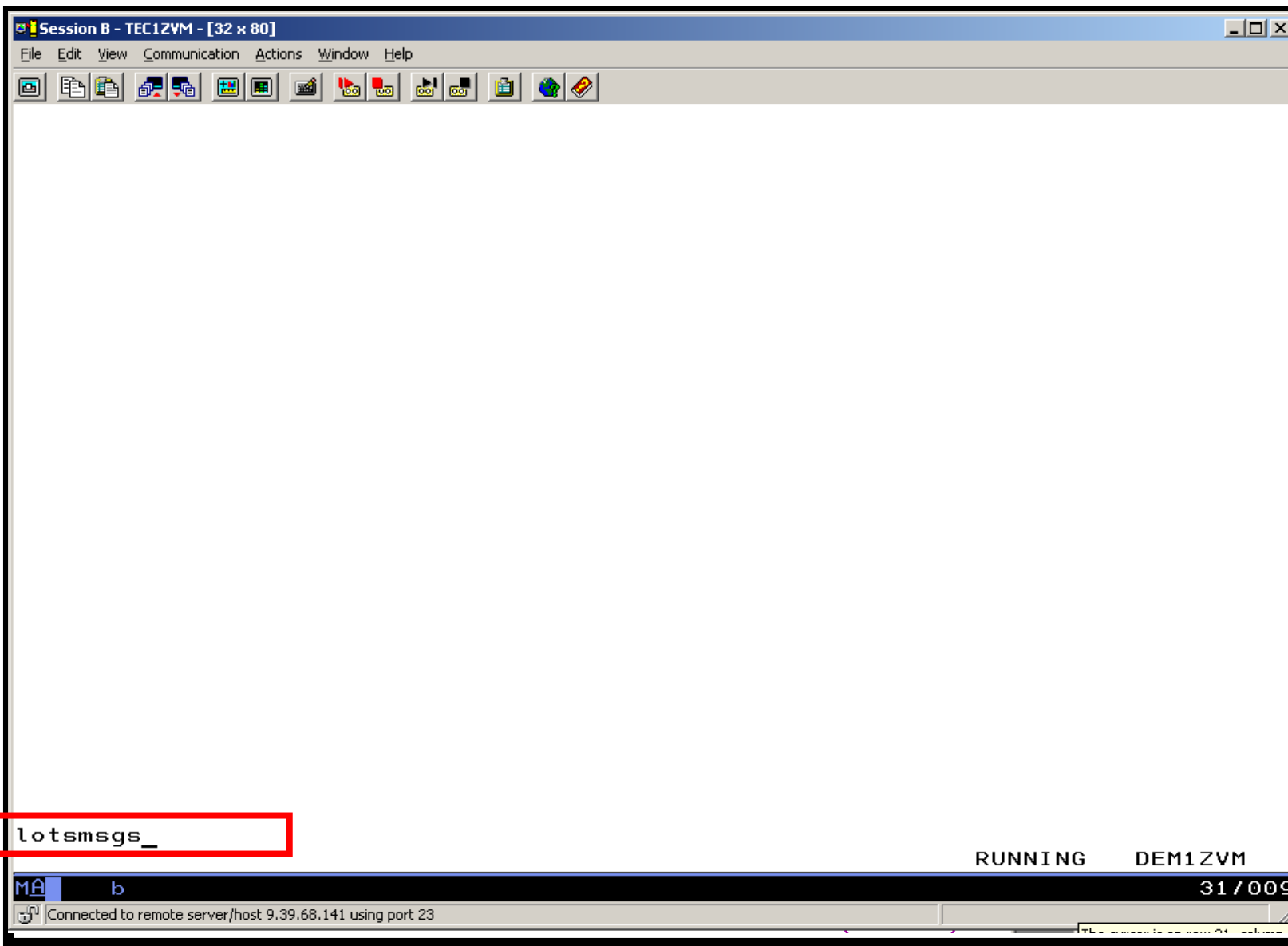
```
Session A - TSTADMN1 - [32 x 80]
File Edit View Communication Actions Window Help
11:54:03 A FAKE ABEND HAS OCCURRED
14:13:50 A fake abend has occurred
17:40:26 DIRMAINT : TEST MESSAGE WITH ABEND TEXT
10:36:23 DIRMAINT : THIS IS A TEST ABEND MESSAGE
10:46:16 A fake abend has occurred
10:46:23 This is standard non scary message 8
10:46:25 This is standard non scary message 9
10:46:26 This is standard non scary message 10
10:46:26 This is standard non scary message 11
10:46:27 This is standard non scary message 12
10:46:28 This is standard non scary message 13
10:46:29 This is standard non scary message 14
10:46:30 This is standard non scary message 15
10:46:31 This is standard non scary message 16
10:46:32 This is standard non scary message 17
10:46:33 This is standard non scary message 18
10:46:34 This is standard non scary message 19
10:46:35 This is standard non scary message 20
10:46:36 This is standard non scary message 21
10:46:37 This is standard non scary message 22
10:46:38 This is standard non scary message 23
10:46:39 This is standard non scary message 24
10:46:40 This is standard non scary message 25
10:46:41 A fake fatal message
10:46:42 This is standard non scary message 1
10:46:43 This is standard non scary message 2
10:46:44 This is standard non scary message 3
10:46:45 This is standard non scary message 4
10:46:47 This is standard non scary message 5
10:46:48 This is standard non scary message 6
-
OPER8 (Scroll)
31 / 001
Connected to remote server/host 9.39.68.141 using port 23
```

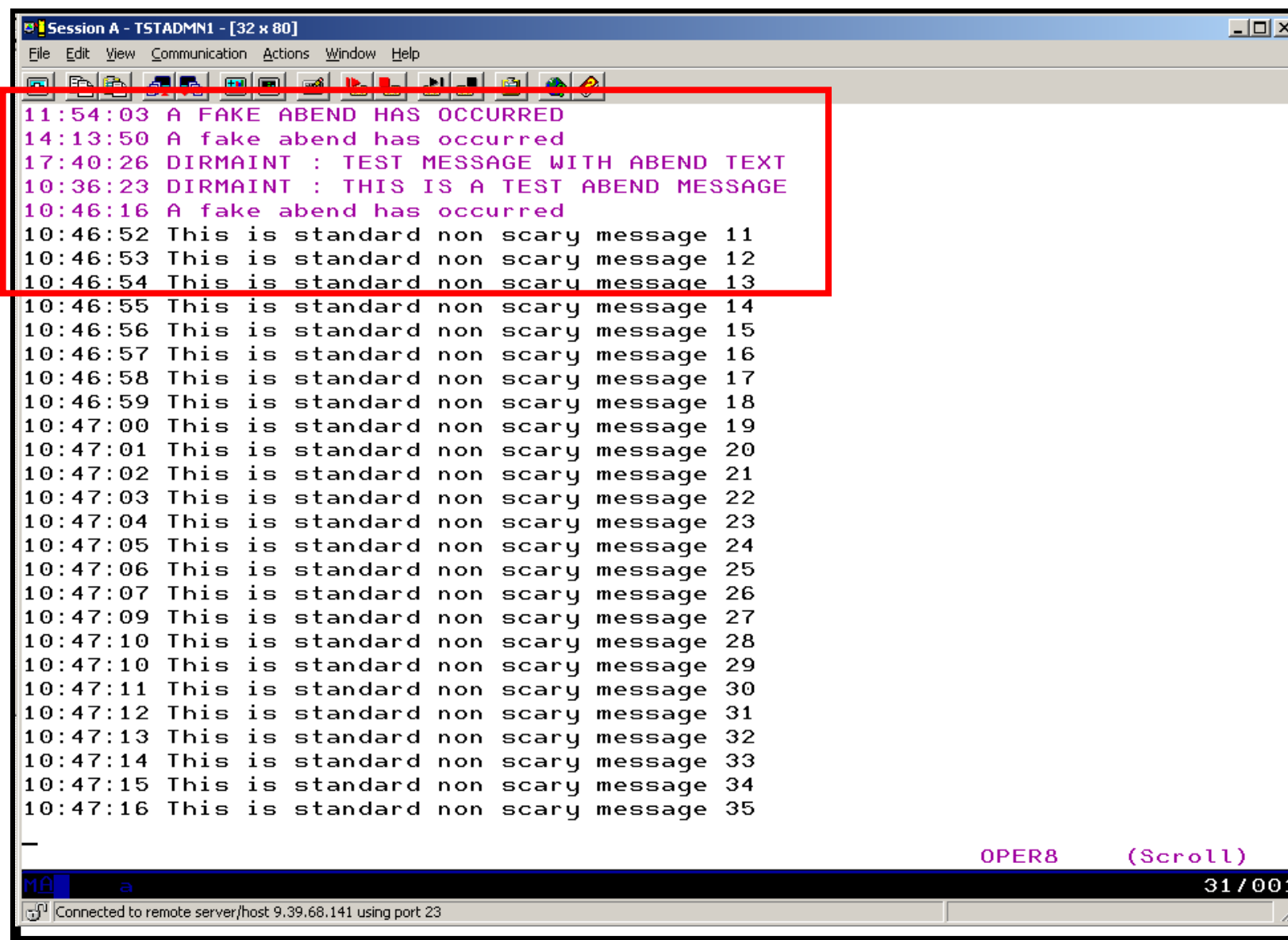

```
Session A - TSTADMIN1 - [32 x 80]
File Edit View Communication Actions Window Help
11:54:03 A FAKE ABEND HAS OCCURRED
14:13:50 A fake abend has occurred
17:40:26 DIRMAINT : TEST MESSAGE WITH ABEND TEXT
10:36:23 DIRMAINT : THIS IS A TEST ABEND MESSAGE
10:46:16 A fake abend has occurred
10:46:52 This is standard non scary message 11
10:46:53 This is standard non scary message 12
10:46:54 This is standard non scary message 13
10:46:55 This is standard non scary message 14
10:46:56 This is standard non scary message 15
10:46:57 This is standard non scary message 16
10:46:58 This is standard non scary message 17
10:46:59 This is standard non scary message 18
10:47:00 This is standard non scary message 19
10:47:01 This is standard non scary message 20
10:47:02 This is standard non scary message 21
10:47:03 This is standard non scary message 22
10:47:04 This is standard non scary message 23
10:47:05 This is standard non scary message 24
10:47:06 This is standard non scary message 25
10:47:07 This is standard non scary message 26
10:47:09 This is standard non scary message 27
10:47:10 This is standard non scary message 28
10:47:10 This is standard non scary message 29
10:47:11 This is standard non scary message 30
10:47:12 This is standard non scary message 31
10:47:13 This is standard non scary message 32
10:47:14 This is standard non scary message 33
10:47:15 This is standard non scary message 34
10:47:16 This is standard non scary message 35
-
OPER8 (Scroll)
MA a 31 / 001
Connected to remote server/host 9.39.68.141 using port 23
```

Scenario 9: How Do You Do That?

Console rules in Operations Manager:

```
*  
DEFRULE NAME(ABEND) ,+  
  MATCH(*abend*) ,+  
  EXUSER(OPER8) ,+  
  ACTION(MSGOPER8)  
  
*  
DEFRULE NAME(FATAL) ,+  
  MATCH(*fatal*) ,+  
  EXUSER(OPER8) ,+  
  ACTION(MSGOPER8)  
  
*  
DEFRULE NAME(EMSGS) ,+  
  MATCH(DMS*E) ,+  
  MCOL(001:011) ,+  
  EXUSER(OPER8) ,+  
  ACTION(MSGOPER8)
```

Action in Operations Manager:

```
*  
DEFACTN NAME(MSGOPER8) ,+  
  COMMAND(CP MSGNOH OPER8 &U : &T) ,+  
  OUTPUT(LOG) ,+  
  ENV(LVM)
```

Scenario 9: How Do You Do That?

Console rules in Operations Manager:

```
*  
DEFRULE NAME (ABENDHLT) , +  
    MATCH (*abend* ) , +  
    USER (OPER8) , +  
    ACTION (HLTHOLD)  
*  
DEFRULE NAME (FATALRED) , +  
    MATCH (*fatal* ) , +  
    USER (OPER8) , +  
    ACTION (RED)
```

Actions in Operations Manager:

```
*  
DEFACTN NAME (HLTHOLD) , +  
    INPUT (AHI , HLD)  
*  
DEFACTN NAME (HILITE) , +  
    INPUT (AHI)  
*  
DEFACTN NAME (RED) , +  
    INPUT (CRE)
```

Scenario 10a:

Create a Central Operations Console across multiple z/VM systems in an **SSI cluster** – Includes relocation of Linux and CMS guests

- **Use Operations Manager to watch for error, warning, fatal messages on service machine consoles on one or more systems in an SSI cluster**
 - OPERATOR, DIRMAINT, TCPIP, RACF, etc.
 - Linux guests
 - Linux syslog
- **Route these messages to a central operations console on one of the z/VM systems**
- **Operations staff watches one operations console for signs of trouble across multiple z/VM systems**
 - View individual service machine consoles for more details when needed

Creating a Central Console Across Multiple Members of SSI Cluster

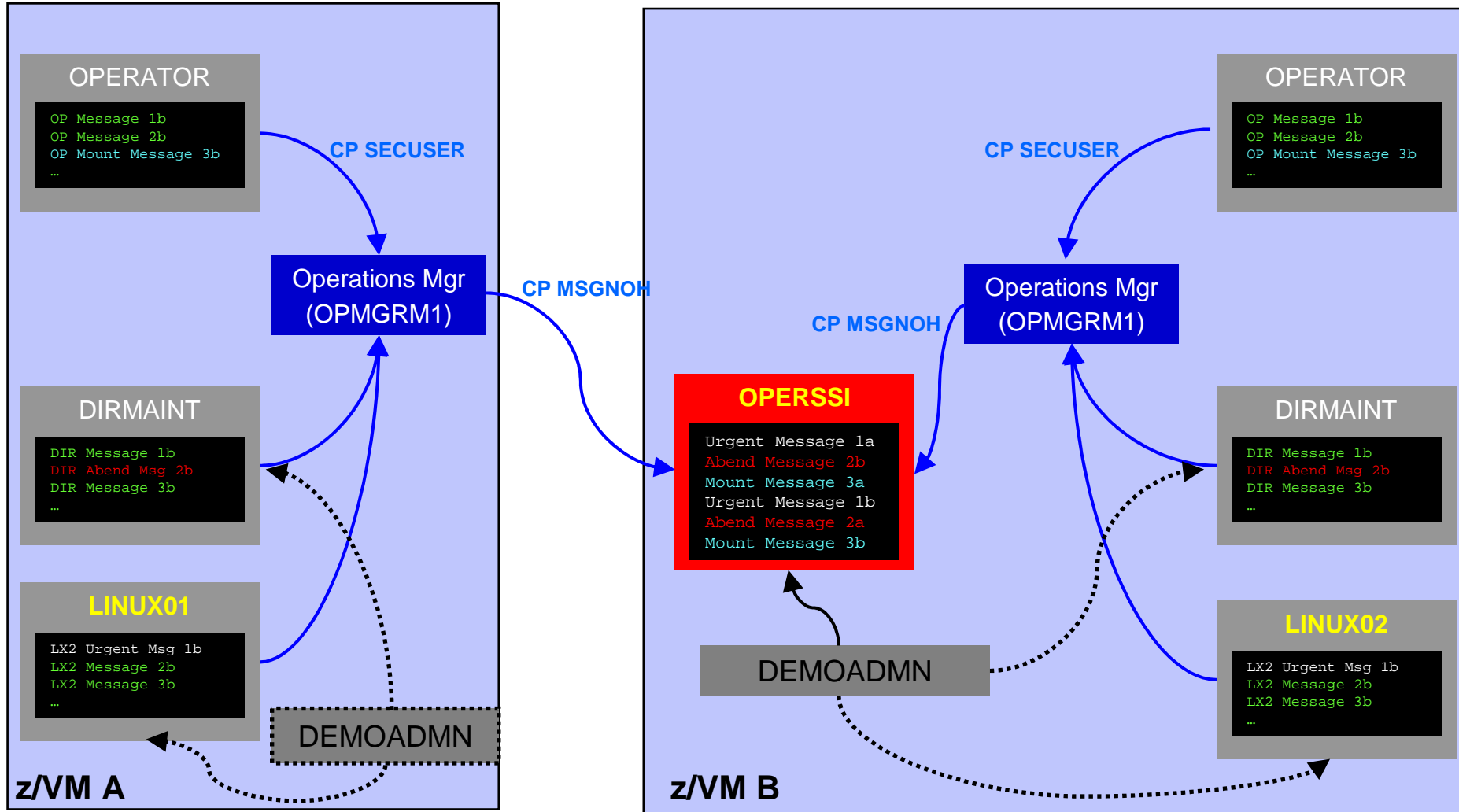

Single Configuration Users: LINUX01, LINUX02, OPERSSI, DEMOADMN
Multiconfiguration (IDENTITY) Users: OPERATOR, DIRMAINT, OPMGRM1

Scenario 10a: Detailed Steps

- **On System B (TEST7SSI), view the “Operations Console” (user ID OPERSSI)**

```
gomcmd opmgrm1 viewcon user(operssi)
```

- **On System A (TEST7SSI), find a Linux guest running disconnected locally and relocate it**

```
q names
```

```
VMRELOCATE MOVE USER RHEL5G TO TESTCSSI
```

- **On System B (TEST7SSI), prepare for planned shutdown by relocating the central operations console (OPERSSI)**

```
VMRELOCATE MOVE USER OPERSSI TO TESTCSSI
```

- **Note the messages received on OPERSSI on TEST7SSI from OPERATOR on both TESTCSSI and TEST7SSI indicating RHEL5G was relocated**
- **Note the message received on OPERSSI on TESTCSSI indicating OPERSSI has been relocated**

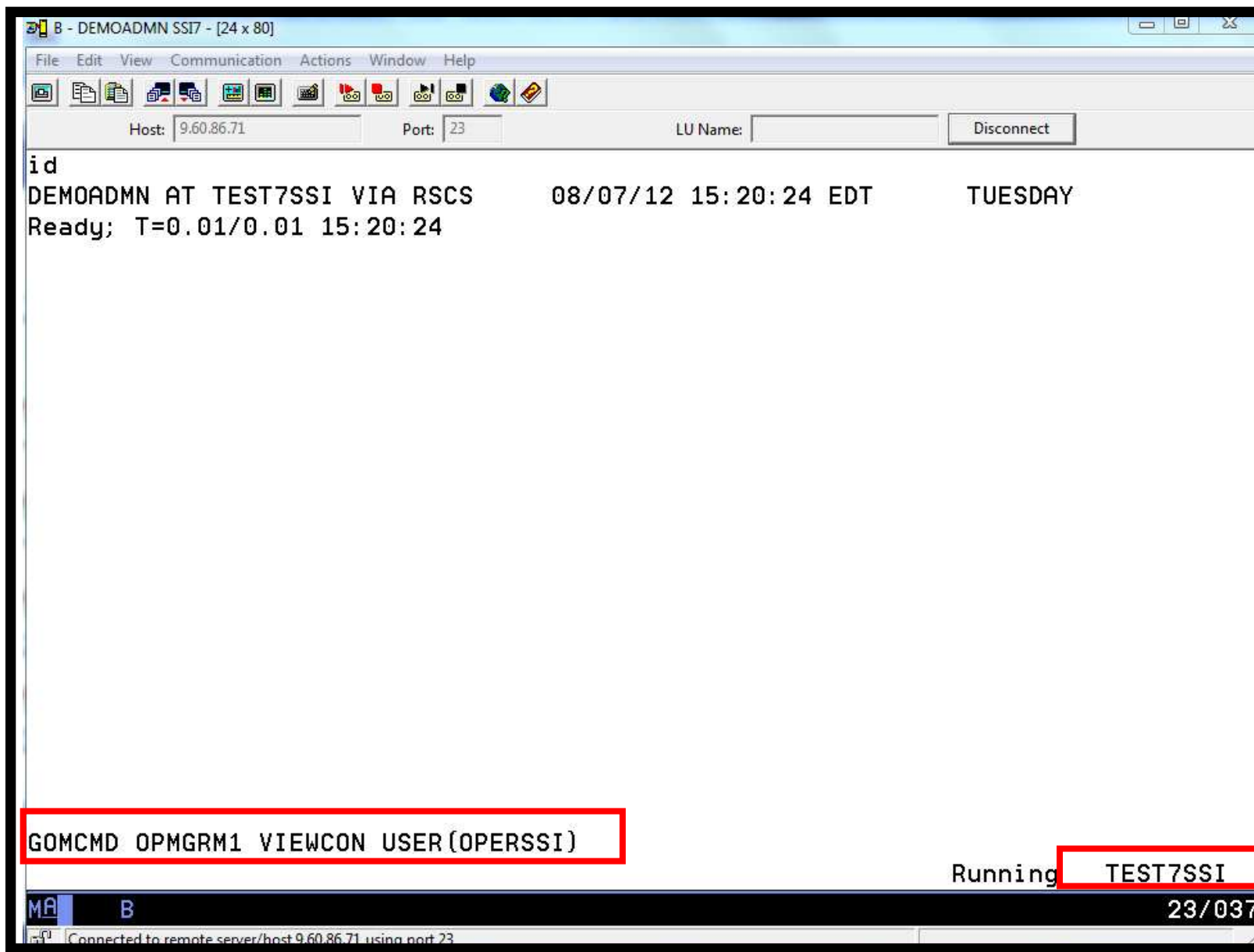

A - DEMOADMN SSI7 - [32 x 80]

File Edit View Communication Actions Window Help

Host: 9.60.86.71 Port: 23 LU Name: Disconnect

```
05:50:32 User OPERSSI has been relocated from TESTCSSI to TEST7SSI
05:50:32 From OPERATOR on TESTCSSI : User OPERSSI has been relocated from TESTC
05:50:32 From OPERATOR on TEST7SSI : User OPERSSI has been relocated from TESTC
05:51:08 From TEST7SSI : Inbound relocation for RHEL5G on TESTCSSI started
05:51:08 From TESTCSSI : Outbound relocation for RHEL5G on TEST7SSI started
05:51:09 From OPERATOR on TEST7SSI : User RHEL5G has been relocated from TESTCS
05:51:09 From OPERATOR on TESTCSSI : User RHEL5G has been relocated from TESTCS
```

PF01= SCROLL PF02= PF03= END PF04= PF05= HOLD PF06= FORMAT
PF07= UP PF08= DOWN PF09= PF10= LEFT PF11= RIGHT PF12= RECALL

OPERSSI (Scroll)

MA A 31/001

Connected to remote server/host 9.60.86.71 using port 23

The screenshot shows a terminal window titled "B - MAINT SSI7 - [24 x 80]". The window has a menu bar (File, Edit, View, Communication, Actions, Window, Help) and a toolbar. Below the toolbar, there are fields for "Host: 9.60.86.71", "Port: 23", and "LU Name:" with a "Disconnect" button. The main content is a list of user names and their associated systems, followed by a command and its output. The command "VMRELOCATE MOVE USER RHEL5G TO TESTCSSI" is highlighted with a red box. The output shows the relocation of user RHEL5G from TEST7SSI to TESTCSSI. At the bottom right, the text "Running TEST7SSI" is highlighted with a red box. The terminal status bar at the bottom shows "MA B" and "23/001".

```
q names
DIRMSAT2 SSI , DATAMOV2 - SSI
RHEL5G - DSC , OPERSSI - DSC , DEMOADMN -L0004, MAINT -L0005
OPMGRS4 - DSC , OPMGRS3 - DSC , OPMGRS2 - DSC , OPMGRS1 - DSC
OPMGRM1 - DSC , RHEL6D - DSC , BKRBKUP - DSC , BKRCATLG - DSC
BKRSVSFS - DSC , SLES11C - DSC , SLES11D - DSC , DATAMOVE - DSC
DIRMAINT - DSC , TOOLS - DSC , MONGRID - DSC , LOGS - DSC
RSCS - DSC , LINUXSRV - DSC , PVM - DSC , IPGATE - DSC
PERFSVM - DSC , GCS - DSC , FTPSERVE - DSC , SMTP - DSC
TCPIP - DSC , DTCVSW2 - DSC , DTCVSW1 - DSC , OPERATNS - DSC
ATSSERV - DSC , VMSERV - DSC , VMSERVU - DSC , VMSERVP - DSC
VMSERVS - DSC , RACFVM - DSC , OPERSYMP - DSC , DISKACNT - DSC
EREP - DSC , OPERATOR - DSC , MAINT620 -L0007
VSM - TCPIP
Ready; T=0.01/0.01 05:55:05
VMRELOCATE MOVE USER RHEL5G TO TESTCSSI
Relocation of RHEL5G from TEST7SSI to TESTCSSI started
User RHEL5G has been relocated from TEST7SSI to TESTCSSI
Ready; T=0.01/0.01 05:57:32

Running TEST7SSI
MA B 23/001
Connected to remote server/host 9.60.86.71 using port 23
```

```
B - MAINT SSI7 - [24 x 80]
File Edit View Communication Actions Window Help
Host: 9.60.86.71 Port: 23 LU Name: Disconnect
q names
DIRMSAT2 - SSI , DATAMOV2 - SSI
RHEL5G - DSC , OPERSSI - DSC , DEMOADMN -L0004, MAINT -L0005
OPMGRS4 - DSC , OPMGRS3 - DSC , OPMGRS2 - DSC , OPMGRS1 - DSC
OPMGRM1 - DSC , RHEL6D - DSC , BKRBKUP - DSC , BKRCATLG - DSC
BKRSVSFS - DSC , SLES11C - DSC , SLES11D - DSC , DATAMOVE - DSC
DIRMAINT - DSC , TOOLS - DSC , MONGRID - DSC , LOGS - DSC
RSCS - DSC , LINUXSRV - DSC , PVM - DSC , IPGATE - DSC
PERFSVM - DSC , GCS - DSC , FTPSERVE - DSC , SMTP - DSC
TCPIP - DSC , DTCVSW2 - DSC , DTCVSW1 - DSC , OPERATNS - DSC
ATSSERV - DSC , VMSEVR - DSC , VMSERVU - DSC , VMSERVP - DSC
VMSERVS - DSC , RACFVM - DSC , OPERSYMP - DSC , DISKACNT - DSC
EREP - DSC , OPERATOR - DSC , MAINT620 -L0007
VSM - TCPIP
Ready; T=0.01/0.01 05:55:05
VMRELOCATE MOVE USER RHEL5G TO TESTCSSI
Relocation of RHEL5G from TEST7SSI to TESTCSSI started
User RHEL5G has been relocated from TEST7SSI to TESTCSSI
Ready; T=0.01/0.01 05:57:32
VMRELOCATE MOVE USER operssi TO TESTCSSI
Relocation of OPERSSI from TEST7SSI to TESTCSSI started
User OPERSSI has been relocated from TEST7SSI to TESTCSSI
Holding TEST7SSI
MA B 23/001
Connected to remote server/host 9.60.86.71 using port 23
```

A screenshot of a terminal window titled "A - DEMOADMN SSI7 - [32 x 80]". The window has a menu bar (File, Edit, View, Communication, Actions, Window, Help) and a toolbar. Below the toolbar, there are fields for "Host: 9.60.86.71", "Port: 23", and "LU Name:", along with a "Disconnect" button. The main area contains a log of system events:

```
05:50:32 User OPERSSI has been relocated from TESTCSSI to TEST7SSI
05:50:32 From OPERATOR on TESTCSSI : User OPERSSI has been relocated from TESTC
05:50:32 From OPERATOR on TEST7SSI : User OPERSSI has been relocated from TESTC
05:51:08 From TEST7SSI : Inbound relocation for RHEL5G on TESTCSSI started
05:51:08 From TESTCSSI : Outbound relocation for RHEL5G on TEST7SSI started
05:51:09 From OPERATOR on TEST7SSI : User RHEL5G has been relocated from TESTCS
05:51:09 From OPERATOR on TESTCSSI : User RHEL5G has been relocated from TESTCS
05:57:31 From TEST7SSI : Outbound relocation for RHEL5G on TESTCSSI started
05:57:31 From TESTCSSI : Inbound relocation for RHEL5G on TEST7SSI started
05:57:32 From OPERATOR on TEST7SSI : User RHEL5G has been relocated from TEST7S
05:57:32 From OPERATOR on TESTCSSI : User RHEL5G has been relocated from TEST7S
05:59:34 From TEST7SSI : Outbound relocation for OPERSSI on TESTCSSI started
05:59:34 From TESTCSSI : Inbound relocation for OPERSSI on TEST7SSI started
```

At the bottom of the terminal, there are function key definitions:

```
PF01= SCROLL PF02=          PF03= END      PF04=          PF05= HOLD    PF06= FORMAT
PF07= UP      PF08= DOWN    PF09=          PF10= LEFT    PF11= RIGHT   PF12= RECALL
```

Below these definitions, the text "OPERSSI (Scroll)" is displayed and highlighted with a red box. At the bottom left, there is a status bar showing "MA A" and "Connected to remote server/host 9.60.86.71 using port 23". At the bottom right, the text "31/001" is visible.

The screenshot shows a terminal window titled "C - DEMOADM2 SSSIC - [24 x 80]". The window contains a list of system jobs and a message about user relocation. The jobs listed are:

```

14:09:12 OPMGRS2 - DSC , OPMGRS1 - DSC , OPMGRM1 - DSC , BKRCATLG - DSC
14:09:12 BKRKBKUP - DSC , DIRMSAT2 - DSC , RHEL5G - DSC , VMSERVV - DSC
14:09:12 DATAMOV2 - DSC , RSCS - DSC , PVM - DSC , PERFSVM - DSC
14:09:12 GCS - DSC , FTPSERVE - DSC , SMTP - DSC , TCPIP - DSC
14:09:12 DTCVSW2 - DSC , DTCVSW1 - DSC , OPERATNS - DSC , VMSERVU - DSC
14:09:12 VMSERVS - DSC , RACFVM - DSC , OPERSYMP - DSC , DISKACNT - DSC
14:09:12 EREP - DSC , OPERATOR - DSC , OPERSSI - DSC
14:09:12 VSM - TCPIP
14:09:12 Ready; T=0.01/0.01 14:09:12
14:09:15 * -- Operations Manager VIEWCON session from DEMOADMN entered the foll
14:09:15 id
14:09:15 OPERSSI AT TESTCSSI VIA RSCS 10/13/12 14:09:15 EDT SATURDAY
14:09:15 Ready; T=0.01/0.01 14:09:15
00:00:00 HCPMID6001I TIME IS 00:00:00 EDT SUNDAY 10/14/12
00:00:00
00:00:00 HCPMID6001I TIME IS 00:00:00 EDT MONDAY 10/15/12
00:00:00
00:00:00 HCPMID6001I TIME IS 00:00:00 EDT TUESDAY 10/16/12
00:00:00
05:59:34 User OPERSSI has been relocated from TEST7SSI to TESTCSSI
PF01= SCROLL PF02= PF03= END PF04= PF05= HOLD PF06= FORMAT
PF07= UP PF08= DOWN PF09= PF10= LEFT PF11= RIGHT PF12= RECALL
OPERSSI (Scroll)

```

The terminal window also shows a status bar at the bottom with "MA C" and "237 001". The status bar at the very bottom of the window indicates "Connected to remote server/host 9.60.86.170 using port 23".

Scenario 10a: How Do You Do That?

Event monitor in Operations Manager:

```
*  
*** Notify OPERSSI console when relocations started  
DEFEMON NAME(RELOC),+  
    TYPE(9,10),+  
    ACTION(RELOC)
```

Action in Operations Manager:

```
*  
DEFACTN NAME(RELOC),+  
    COMMAND(EXEC MSG2OPER &u &3 &4 &5 junk),+  
    ENV(LVM)
```

Scenario 10a: How Do You Do That?

MSG2OPER EXEC (excerpts):

```
/* Send a message to a central console OPERSSI for SSI cluster */
/* */
trace r
Address Command
Parse arg userid euser event sourcesys msgtext

/* Get local TCP/IP hostname */
parse value Search_TCPIP_Data("hostname") with getrc tcphostname .
if getrc > 4 then tcphostname = "unknown_host_name"

if userid = '_GOMEMON' then
do
  if event = 9 then
    msgtext = 'Outbound relocation for' euser 'on' sourcesys 'started'
  else
    msgtext = 'Inbound relocation for' euser 'on' sourcesys 'started'
  'CP MSGNOH OPERSSI AT TEST7SSI From' tcphostname ':' msgtext
end
```

Scenario 10b:

Create a Central Operations Console across multiple z/VM systems that are **not in an SSI cluster**

- **Use Operations Manager to watch for error, warning, fatal messages on service machine consoles on one or more systems**
 - OPERATOR, DIRMAINT, TCP/IP, RACF, etc.
 - Linux guests
 - Linux syslog
- **Route these messages to a central operations console on one of the z/VM systems**
- **Operations staff watches one operations console for signs of trouble across multiple z/VM systems**
 - View individual service machine consoles for more details when needed

Creating a Central Console Across Multiple LPARS

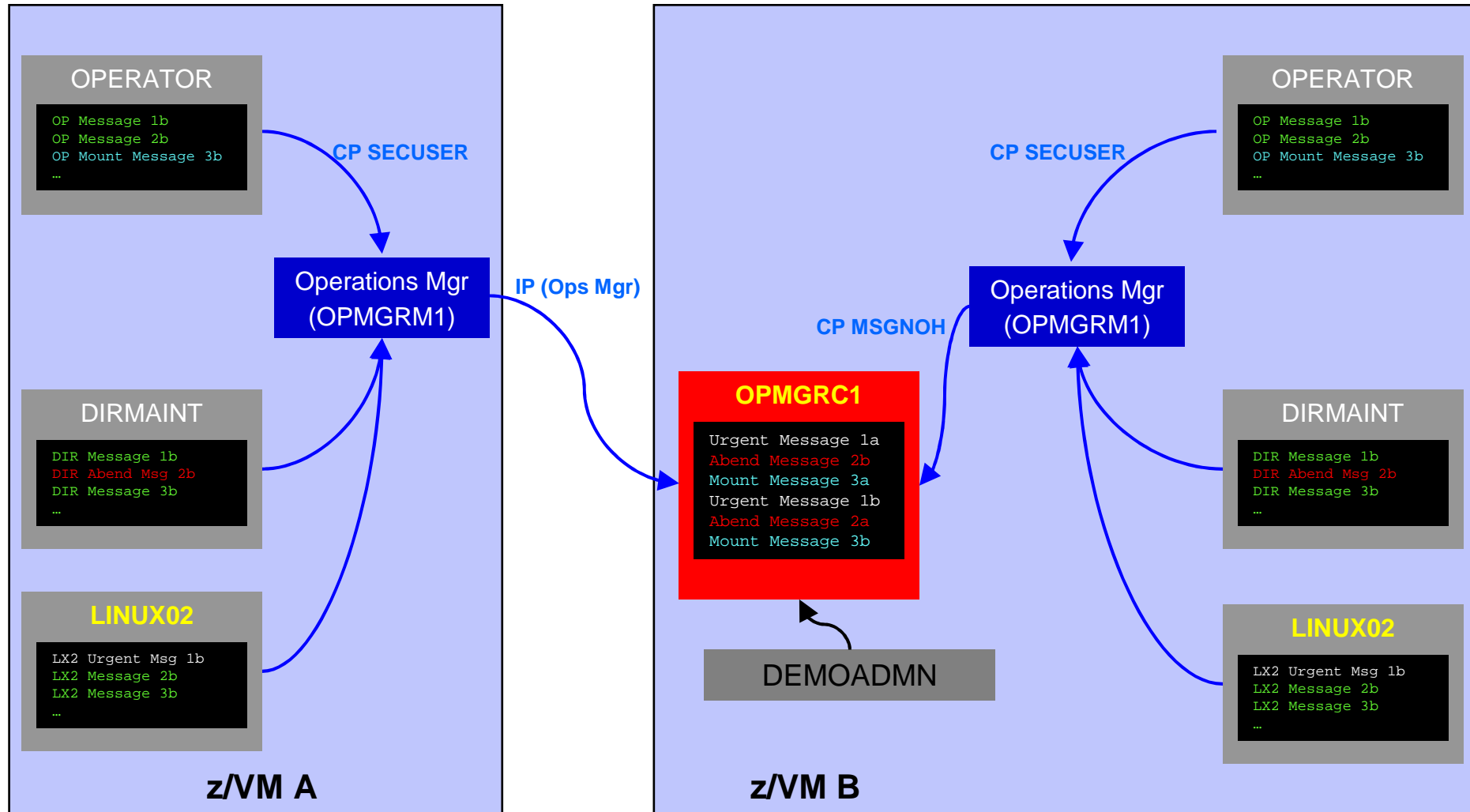

```
Session B - MAINT SSIC - [24 x 80]
File Edit View Communication Actions Window Help
msgnoh operator here is a test remote error message
Ready; T=0.01/0.01 21:58:52

gomcmd opmgrm1 viewcon user(operator)
Running TESTCSSI
MR b
23/038
Connected to remote server/host 9.60.86.170 using port 23
```

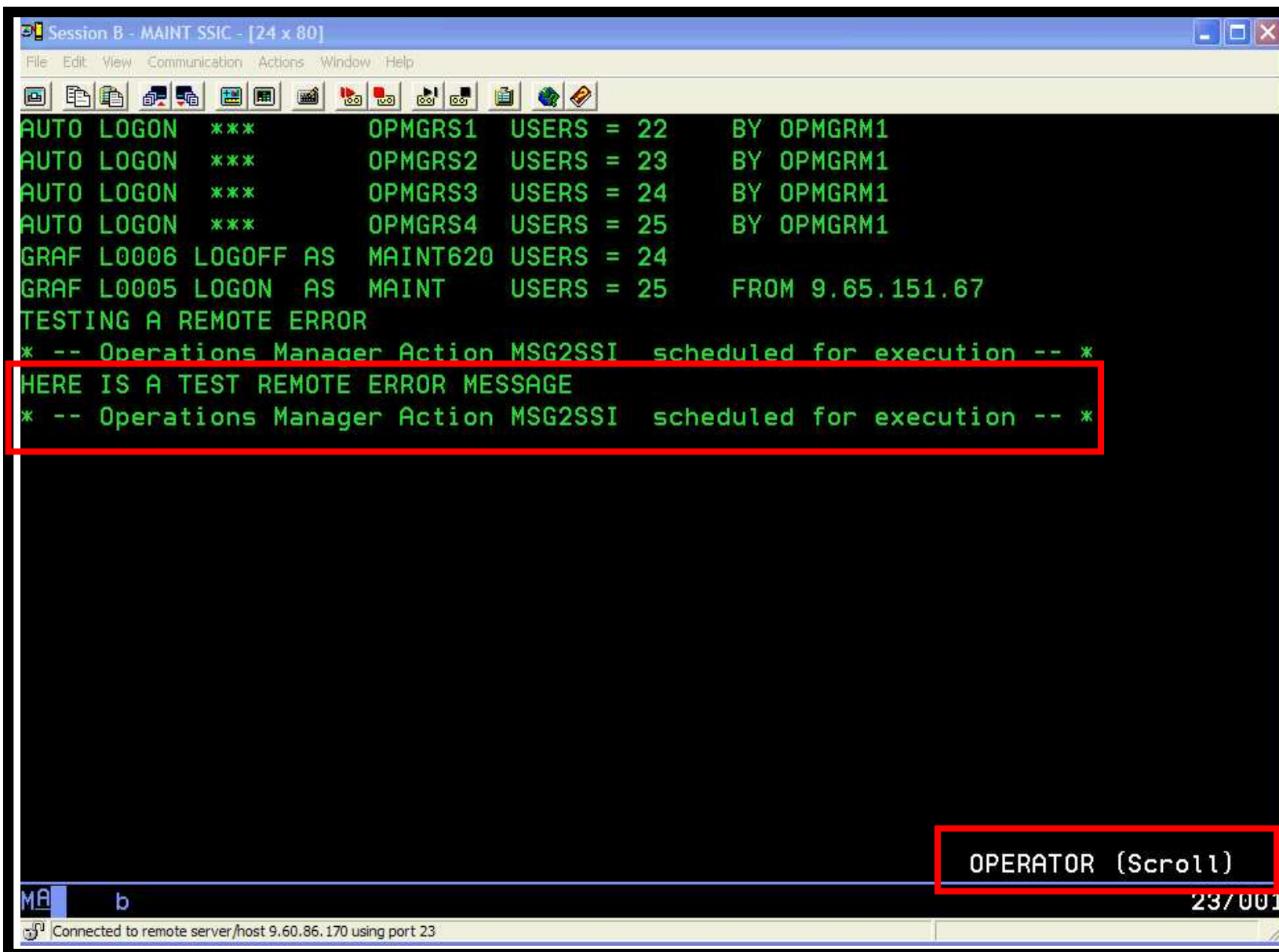

The screenshot shows a terminal window titled "Session B - MAINT SSIC - [24 x 80]". The window contains the following text:

```
File Edit View Communication Actions Window Help
AUTO LOGON *** OPMGRS1 USERS = 22 BY OPMGRM1
AUTO LOGON *** OPMGRS2 USERS = 23 BY OPMGRM1
AUTO LOGON *** OPMGRS3 USERS = 24 BY OPMGRM1
AUTO LOGON *** OPMGRS4 USERS = 25 BY OPMGRM1
GRAF L0006 LOGOFF AS MAINT620 USERS = 24
GRAF L0005 LOGON AS MAINT USERS = 25 FROM 9.65.151.67
TESTING A REMOTE ERROR
* -- Operations Manager Action MSG2SSI scheduled for execution -- *
HERE IS A TEST REMOTE ERROR MESSAGE
* -- Operations Manager Action MSG2SSI scheduled for execution -- *
```

A red box highlights the test message section. At the bottom right of the terminal, the text "OPERATOR (Scroll)" is displayed in a red box. The status bar at the bottom shows "MA b" on the left and "23/001" on the right. The connection information at the very bottom reads "Connected to remote server/host 9.60.86.170 using port 23".

Scenario 10b: Detailed Steps

- **On System A (DEM1ZVM) put an “error” message on the OPERATOR console**
 - Must contain the text “remote error”

```
msgnoh operator here is a remote error message
```

- **View the “Operations Console” (user ID OPMGRC1) on System B (ZVMV5R40) to see the message**

```
gomcmd opmgrm1 viewcon user(opmgrc1)
```

- **Note the message received on OPMGRC1 on ZVMV5R40 from OPERATOR on DEM1ZVM**

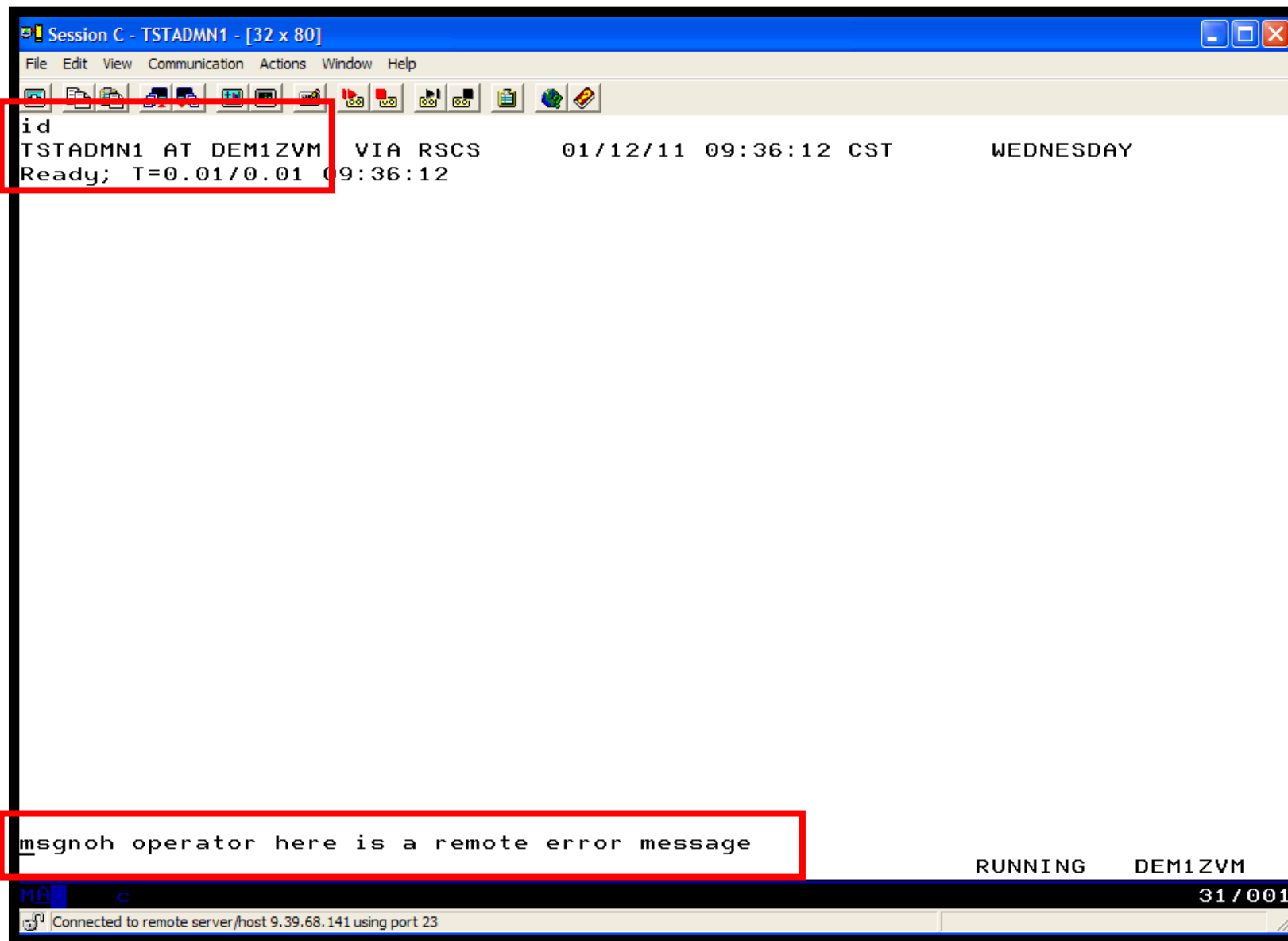

The screenshot shows a terminal window with a blue title bar and a menu bar (File, Edit, View, Communication, Actions, Window, Help). The main area contains the following text:

```
id  
DEMOADMN AT ZVMV5R40 VIA RSCS      01/12/11 11:15:16 EDT      WEDNESDAY  
Ready: T=0 01/12/11 11:15:16
```

A red box highlights the first two lines of the output. At the bottom of the terminal, a command prompt is shown:

```
gomcmd opmgrm1 viewcon user(opmgrc1)_
```

Below the command prompt, the text "RUNNING ZVMV5R40" is visible. The bottom status bar shows "MA b" on the left and "31 / 037" on the right. A small icon and text at the very bottom indicate the connection: "Connected to remote server/host 9.82.24.129 using port 23".

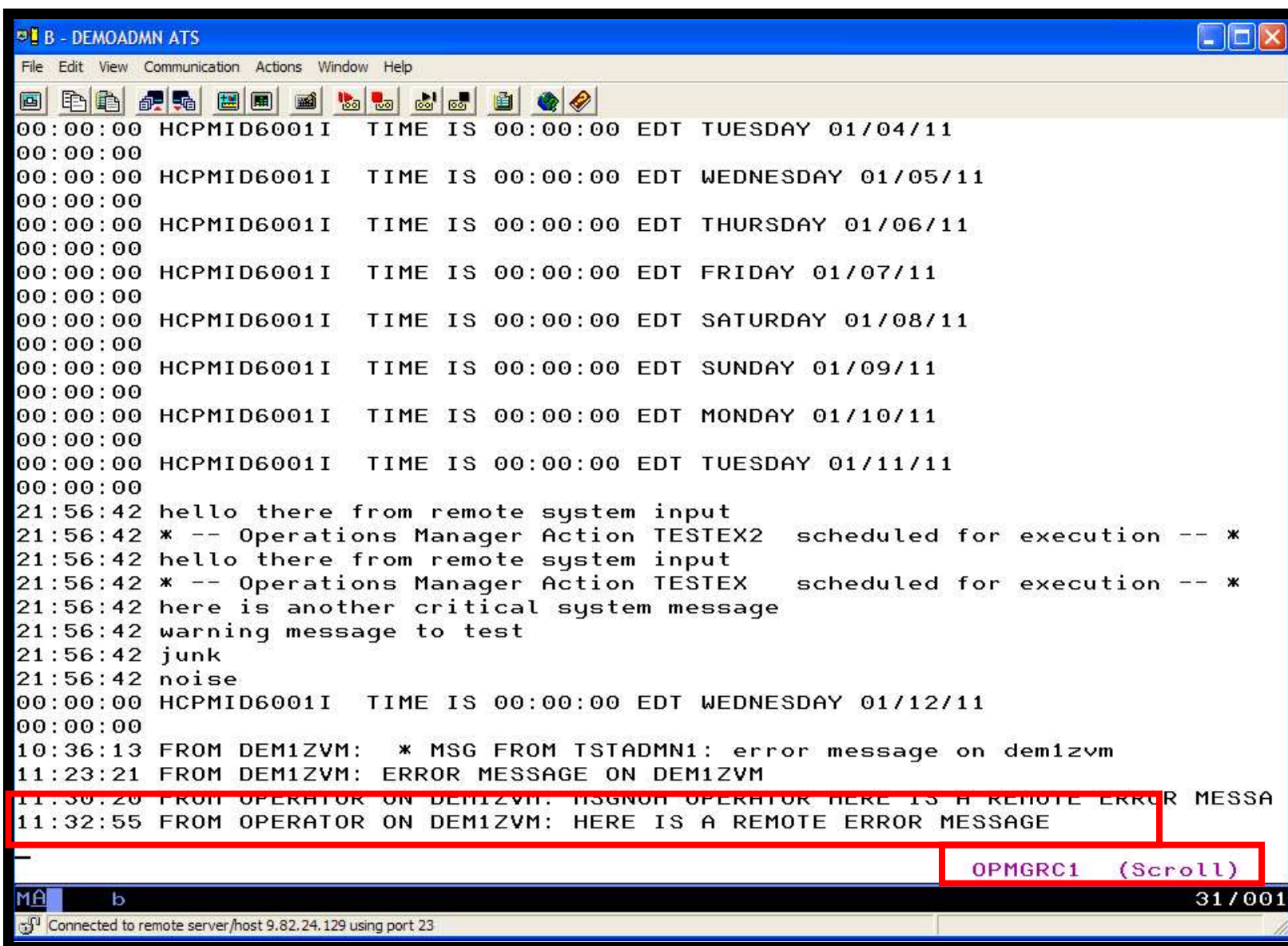

```
B - DEMOADMN ATS
File Edit View Communication Actions Window Help
00:00:00 HCPMID6001I  TIME IS 00:00:00 EDT TUESDAY 01/04/11
00:00:00
00:00:00 HCPMID6001I  TIME IS 00:00:00 EDT WEDNESDAY 01/05/11
00:00:00
00:00:00 HCPMID6001I  TIME IS 00:00:00 EDT THURSDAY 01/06/11
00:00:00
00:00:00 HCPMID6001I  TIME IS 00:00:00 EDT FRIDAY 01/07/11
00:00:00
00:00:00 HCPMID6001I  TIME IS 00:00:00 EDT SATURDAY 01/08/11
00:00:00
00:00:00 HCPMID6001I  TIME IS 00:00:00 EDT SUNDAY 01/09/11
00:00:00
00:00:00 HCPMID6001I  TIME IS 00:00:00 EDT MONDAY 01/10/11
00:00:00
00:00:00 HCPMID6001I  TIME IS 00:00:00 EDT TUESDAY 01/11/11
00:00:00
21:56:42 hello there from remote system input
21:56:42 * -- Operations Manager Action TESTEX2  scheduled for execution -- *
21:56:42 hello there from remote system input
21:56:42 * -- Operations Manager Action TESTEX  scheduled for execution -- *
21:56:42 here is another critical system message
21:56:42 warning message to test
21:56:42 junk
21:56:42 noise
00:00:00 HCPMID6001I  TIME IS 00:00:00 EDT WEDNESDAY 01/12/11
00:00:00
10:36:13 FROM DEM1ZVM:  * MSG FROM TSTADMN1: error message on dem1zvm
11:23:21 FROM DEM1ZVM: ERROR MESSAGE ON DEM1ZVM
11:30:20 FROM OPERATOR ON DEM1ZVM: MSGNOR OPERATOR HERE IS A REMOTE ERROR MESSA
11:32:55 FROM OPERATOR ON DEM1ZVM: HERE IS A REMOTE ERROR MESSAGE
-
OPMGRC1 (Scroll)
MA  b 31/001
Connected to remote server/host 9.82.24.129 using port 23
```

Scenario 10b: How Do You Do That?

Console rule in Operations Manager on System A:

```
*  
DEFRULE NAME(OPERMSGS),+  
  MATCH(*remote error*),+  
  USER(OPERATOR),+  
  ACTION(MSG2GBRG)
```

Action in Operations Manager on System A:

```
*  
DEFACTN NAME(MSG2GBRG),+  
  COMMAND(EXEC MSG2OPS OPMGRC1 From &u on DEM1ZVM: &t),+  
  OUTPUT(LOG),+  
  ENV(LVM)
```

Scenario 10b: How Do You Do That?

MSG2OPS EXEC on System A:

```
/* Send a message to a console in Ops Mgr on another system */
/*
trace r
Address Command
Parse arg cons_user msgtext
'PIPE var msgtext | > TEMP NOTE A'
'EXEC GOMRSIF TEMP NOTE A 9.82.24.129 63000' cons_user
Exit
```

Central Console (OPMGRC1)

IP address of System B

Scenario 10b: How Do You Do That?

TCP/IP listener definition in Operations Manager on System B:

*

```
DEFTCPA NAME( TESTDATA ), +  
  TCPUSER( TCPIP ), +  
  TCPAPPL( GOMRSIF ), +  
  TCPADDR( 000.000.000.000 ), +  
  TCPPORT( 63000 )
```

- **May also need to update TCP/IP on System B to allow Operations Manager to listen on port 63000**
- **Can alternatively use TELL (instead of GOMRSIF) to send messages from System A to System B, but requires RSCS**

Scenario 11

Integration with OMEGAMON XE on z/VM and Linux

- **Use Operations Manager to take action based on a triggered situation in OMEGAMON XE on z/VM and Linux**
- **Virtual CPU consumption is high for a Linux guest**
- **OMEGAMON detects the situation, creates an event, and sends message to Operations Manager**
- **Action is triggered by a rule in Operations Manager**
- **Operations Manager checks SHARE status of guest and issues CP commands to tune the guest**
 - SET QUICKDSP
 - SET SHARE
- **Event is resolved in OMEGAMON when virtual CPU consumption of guest is back down**

OMEGAMON XE and Operations Manager for z/VM



Process Flow

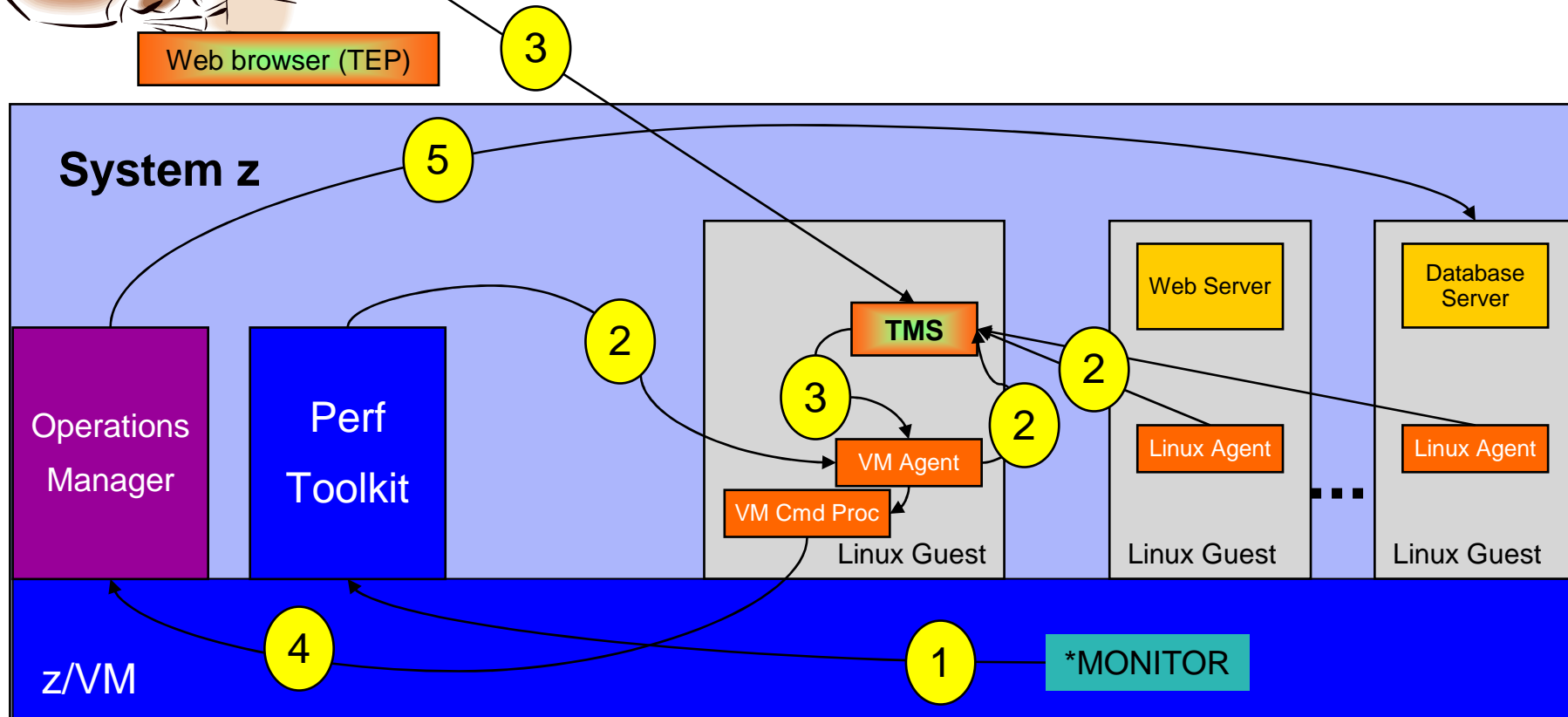

Scenario 11: Detailed Steps

- **Create and start an application on a Linux guest that uses more than 20% of virtual CPU**
 - HOG command on our demo system
- **Updates to Tivoli Enterprise Portal**
 - z/VM CPU graph shows guest CPU % as it runs the application
 - Event pops up on situation event console to say higher than 20%
- **Use Operations Manager to watch z/VM user console used by OMEGAMON**
 - Message receive from OMEGAMON to address high CPU on the guest
 - Message from Operations Manager indicating action is triggered
- **Updates on Tivoli Enterprise Portal**
 - CPU used by that guest decreases below 20%
 - Event closed (removed from the event console)

The screenshot displays the IBM Tivoli Performance Viewer interface with the following components:

- Top Panel:** Window title "HighCPU - hasle330.wsclab.washington.ibm.com - ats03". Menu bar (File, Edit, View, Help) and a toolbar with various icons.
- Left Panel (Navigation):** "View: High CPU" and a tree view showing a hierarchy: High CPU > Hog Wild > Linux Systems > z/OS Systems > z/VM Systems > has115.VL > z/VM Linux Sy > Channel > CP Owne > DASD > LPAR > Network.
- Top-Right Panel (Process View):** "has107:LZ Process View from Linux Agent". A bar chart titled "Process Busy CPU (Percent)" showing CPU usage for various processes. The y-axis lists processes: mingetty, cms, xinetd, kauditd, klogd, kjournald, pdflush, ksoftirqd, and zmd. The x-axis is "Linux Virtual CPU %" from 0 to 100. A legend indicates "Process Busy CPU (Percent)".
- Bottom-Left Panel (z/VM CPU View):** "z/VM CPU Percent View from Performance Toolkit". A line chart titled "has107:LZ Real CPU %" showing CPU usage over time. The y-axis ranges from 8 to 40. The x-axis is "Time" from 13:56:30 to 14:07:00. A legend indicates "has107:LZ Real CPU %".
- Bottom-Right Panel (Terminal):** "Terminal" window showing system output for user SLESAL07. The output includes:

```

03/12/2010 17:52:00          MAXIMUM SHARE = LIMITHA
03/12/2010 17:52:00          ZIIP ABSOLUTE SHARE = 5%
03/12/2010 17:52:00          MAXIMUM SHARE = LIMITHA
03/12/2010 17:52:00 USER SLESAL07: CP  ABSOLUTE SHARE = 100%
03/12/2010 17:52:00          MAXIMUM SHARE = NOLIMIT
03/12/2010 17:52:00          ZAAP ABSOLUTE SHARE = 100%
03/12/2010 17:52:00          MAXIMUM SHARE = NOLIMIT
03/12/2010 17:52:00          IFL ABSOLUTE SHARE = 100%
03/12/2010 17:52:00          MAXIMUM SHARE = NOLIMIT
03/12/2010 17:52:00          ICF ABSOLUTE SHARE = 100%
03/12/2010 17:52:00          MAXIMUM SHARE = NOLIMIT
03/12/2010 17:52:00          ZIIP ABSOLUTE SHARE = 100%
03/12/2010 17:52:00          MAXIMUM SHARE = NOLIMIT
03/12/2010 17:52:00 +-----+
03/12/2010 17:52:00 |The absolute share of 100% has been reset fo
03/12/2010 17:52:00 +-----+
03/12/2010 17:52:00 Ready; T=0.01/0.01 17:52:00
            
```
- Bottom Status Bar:** "Hub Time: Fri, 03/12/2010 05:53 PM", "Server Available", and "HighCPU - hasle330.wsclab.washington.ibm.com - ats03".

The screenshot displays the IBM Tivoli Monitoring console interface. The main window shows a process view for 'has1107:LZ' with a bar chart of CPU usage. A 'Take Action' dialog box is open, showing the following details:

- Action:** Name: HIGH CPU - hog command; Command: /atsshare/unixload/linux/hog -t 32000
- Destination Systems:** BOSPA.ESMTS105:LZ, BOSPA.ESMTS117:LZ, BOSPA.ESMTS118:LZ, has1102:LZ, has1103:LZ, has1107:LZ (selected), has1108:LZ, has1112:LZ, hasle310:LZ, hasle312:LZ, hasle325:LZ, hasle328:LZ, hasle330:LZ

In the bottom right, the 'Situation Event Console' shows a log entry:

```

03/12/2010 17:52:00 |The absolute share of 100% has been reset for
03/12/2010 17:52:00 +-----+
03/12/2010 17:52:00 Ready; T=0.01/0.01 17:52:00
    
```

The console also displays various system parameters such as 'MAXIMUM SHARE = LIMITHA...', 'ZIIP ABSOLUTE SHARE = 5%', and 'CP ABSOLUTE SHARE = 100%'.

The screenshot displays the IBM Tivoli Monitoring console interface. The main window is titled "HighCPU - hasle330.wslab.washington.ibm.com - ats03". It features a navigation pane on the left, a central graph area, and a situation event console on the right.

Navigation Pane: Shows a tree view under "High CPU" with sub-items: "Hog Wild", "Linux Systems", "z/OS Systems", "z/VM Systems", and "has1115.VL". Under "z/VM Linux Sy", there are sub-items: "Channel", "CP Owne", "DASD", "LPAR", and "Network".

Central Graph: Titled "has107:LZ Process View from Linux Agent". It shows a 3D bar chart of "Process Busy CPU (Percent)" for various processes: hog, pdflush, syslog-ng, gdm, khelper, and date. The x-axis is "Linux Virtual CPU %" ranging from 0 to 100. The "hog" process shows a significant spike in CPU usage.

Situation Event Console: Displays a table of alerts:

Severity	Status	Owner	Situation Name	Dis
Critical	Open		Demo_CPU_high	

z/VM CPU Percent View from Performance Toolkit: Shows a line graph of "has107:LZ Real CPU %" over time. The y-axis ranges from 8 to 40. The x-axis shows time from 14:00:00 to 14:50:00. The CPU usage starts at approximately 16%, drops to 8% at 14:05:00, and then gradually increases back to 16% by 14:50:00.

Terminal: Shows system messages:

```

03/12/2010 17:52:00          MAXIMUM SHARE = LIMITHARD AB
03/12/2010 17:52:00 USER SLES107: CP  ABSOLUTE SHARE = 100%
03/12/2010 17:52:00          MAXIMUM SHARE = NOLIMIT
03/12/2010 17:52:00          ZAAP ABSOLUTE SHARE = 100%
03/12/2010 17:52:00          MAXIMUM SHARE = NOLIMIT
03/12/2010 17:52:00          IFL ABSOLUTE SHARE = 100%
03/12/2010 17:52:00          MAXIMUM SHARE = NOLIMIT
03/12/2010 17:52:00          ICF ABSOLUTE SHARE = 100%
03/12/2010 17:52:00          MAXIMUM SHARE = NOLIMIT
03/12/2010 17:52:00          ZIIP ABSOLUTE SHARE = 100%
03/12/2010 17:52:00          MAXIMUM SHARE = NOLIMIT
03/12/2010 17:52:00 +-----+
03/12/2010 17:52:00 |The absolute share of 100% has been reset for SLE
03/12/2010 17:52:00 +-----+
03/12/2010 17:52:00 Ready; T=0.01/0.01 17:52:00
03/12/2010 17:56:31 * MSG FROM OMEGACMD: GUEST SLES107 NEEDS CPU PRI
03/12/2010 17:56:31 * -- Operations Manager Action GUSTCPUB scheduled
    
```

Status Bar: Shows "Hub Time: Fri, 03/12/2010 05:56 PM", "Server Available", and "HighCPU - hasle330.wslab.washington.ibm.com - ats03".

The screenshot displays the HighCPU monitoring interface for a z/VM cluster. The main window shows a process view for 'has107:LZ' with a 3D bar chart of CPU usage for various processes. The 'hog' process is the most active. A 'Situation Event Console' on the right shows a 'Critical' event for 'Demo_CPU_high'. Below, the 'z/VM CPU Percent View from Performance Toolkit' shows a line graph of 'has107:LZ Real CPU %' over time, with a sharp spike at 14:55:00. A terminal window on the bottom right shows system logs, including a message from OMEGACMD: 'GUEST SLES107 NEEDS CPU PRIORITY' and a list of user shares for SLES107.

Severity	Status	Owner	Situation Name	Dis
Critical	Open		Demo_CPU_high	

```

17:52:00 +-----+
17:52:00 Ready; T=0.01/0.01 17:52:00
17:56:31 * MSG FROM OMEGACMD: GUEST SLES107 NEEDS CPU PRIORITY
17:56:31 * -- Operations Manager Action GUSTCPUB scheduled for executi
17:58:08 * -- Operations Manager VIEWCON session from AT501 entered
17:58:08 q share sles107
17:58:08 USER SLES107: CP ABSOLUTE SHARE = 5%
17:58:08 MAXIMUM SHARE = LIMITHARD ABSOLUTE 5%
17:58:08 ZAAP ABSOLUTE SHARE = 5%
17:58:08 MAXIMUM SHARE = LIMITHARD ABSOLUTE 5%
17:58:08 IFL ABSOLUTE SHARE = 5%
17:58:08 MAXIMUM SHARE = LIMITHARD ABSOLUTE 5%
17:58:08 ICF ABSOLUTE SHARE = 5%
17:58:08 MAXIMUM SHARE = LIMITHARD ABSOLUTE 5%
17:58:08 ZIIP ABSOLUTE SHARE = 5%
17:58:08 MAXIMUM SHARE = LIMITHARD ABSOLUTE 5%
17:58:08 Ready; T=0.01/0.01 17:58:09
    
```

The screenshot displays the IBM Tivoli Monitoring console for a system named 'HighCPU - hasle330.wsclab.washington.ibm.com - ats03'. The main window is titled 'has107:LZ Process View from Linux Agent' and shows a bar chart of 'Process Busy CPU (Percent)'. The y-axis lists processes: mingetty, oms, xinetd, kauditd, klogd, kjournald, pdf flush, ksoftirqd, and zmd. The x-axis represents 'Linux Virtual CPU %' from 0 to 100. The 'zmd' process shows a very high CPU usage, indicated by a red bar extending beyond the 100% mark.

Below the main window is the 'z/VM CPU Percent View from Performance Toolkit' window, which shows a line graph of 'has107:LZ Real CPU %' over time. The y-axis ranges from 8 to 40, and the x-axis shows time from 14:05:00 to 14:55:00. The graph shows a steady increase in CPU usage, peaking at approximately 38% around 14:55:00.

On the right side, the 'Situation Event Console' window is visible, showing a table with columns for Severity, Status, Owner, Situation Name, and Dis. Below this, a 'Terminal' window displays system logs, including messages such as 'MSG FROM OMEGACMD: GUEST SLES107 NEEDS CPU PRIORITY' and 'Operations Manager Action GUSTCPUB scheduled for execution'.

The bottom status bar of the console shows 'Hub Time: Fri, 03/12/2010 05:59 PM', 'Server Available', and the system name 'HighCPU - hasle330.wsclab.washington.ibm.com - ats03'.

Scenario 11: How Do You Do That?

Rules in Operations Manager:

```
*  
* Adjust SHARE of Linux guest if CPU usage is too high  
* Watch for message from OMEGAMON  
DEFRULE NAME(GUSTCPU),+  
  MATCH(*NEEDS CPU PRIORITY*),+  
  ACTION(GUESTCPU)  
  
*  
* Highlight message from OMEGAMON and call EXEC to check and adjust  
* SHARE of Linux guest  
DEFACTN NAME(GUESTCPU),+  
  INPUT(AHI),+  
  NEXTACTN(GUSTCPUB)  
  
*  
DEFACTN NAME(GUSTCPUB),+  
  COMMAND(EXEC VCPU &4),+  
  ENV(LVM),+  
  OUTPUT(LOG)
```

Scenario 11: Detailed Steps OMEGAMON Configuration

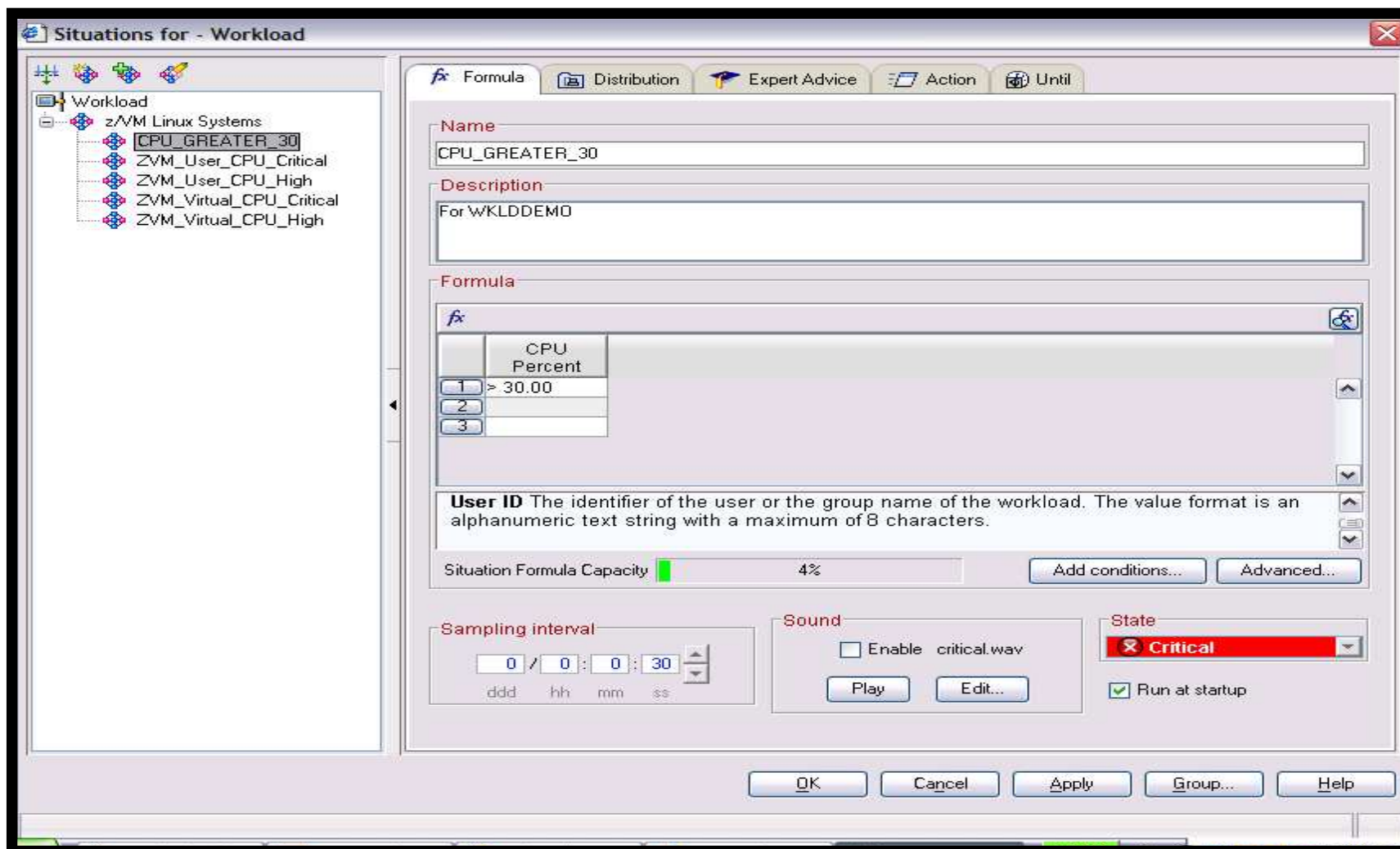

Scenario 11: Detailed Steps OMEGAMON Configuration

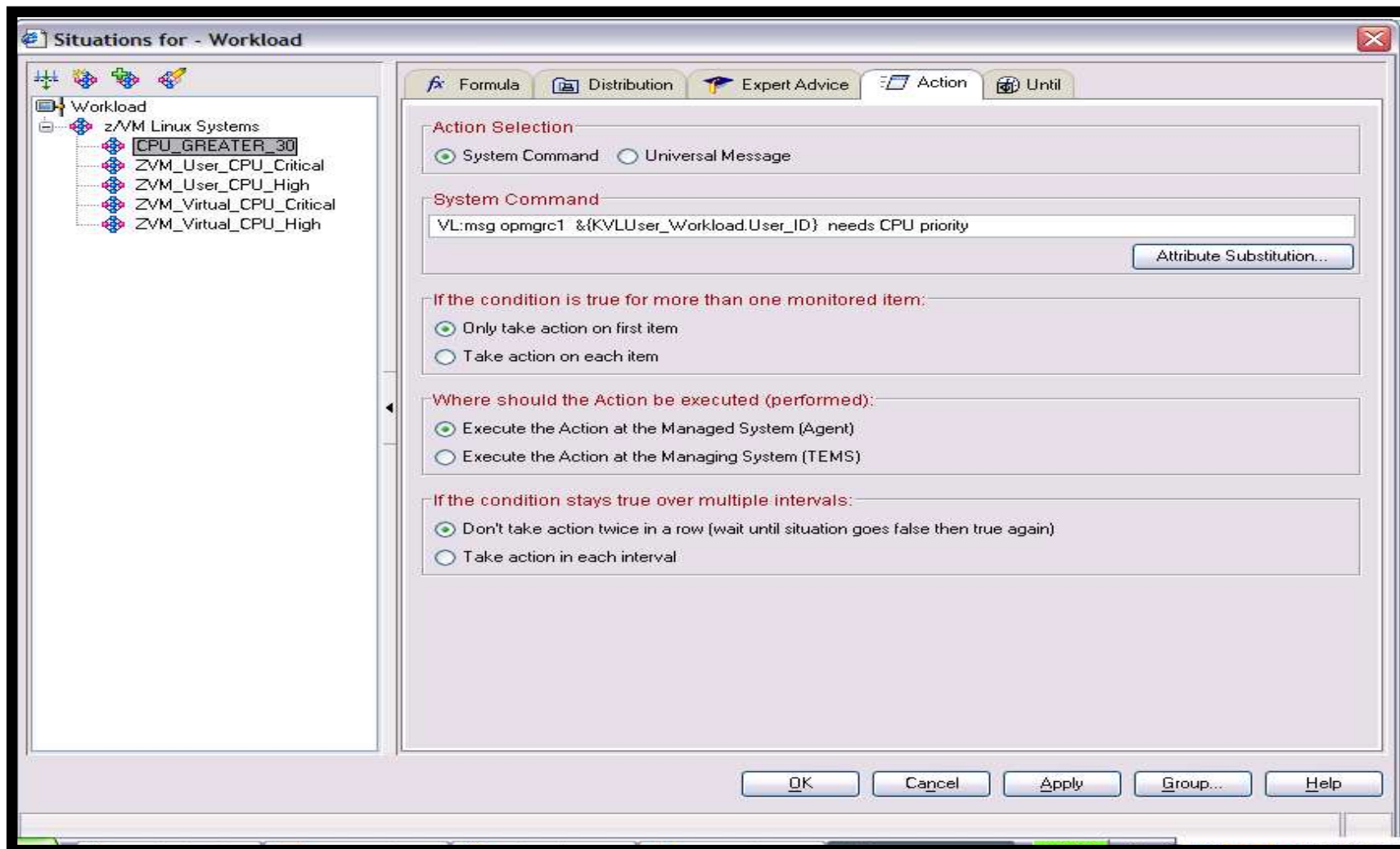

Scenario 12:

Monitor Service Machines for LOGOFF Status – and AUTOLOG them

- **Monitor specific service machines to make sure they stay logged on**
 - Demo will monitor TSTADMIN2 user ID
 - Could monitor a group of user IDs
 - If it changes from logged on to logged off status, then restart it
- **Dynamically pass the user ID to the action**
 - Re-use action for multiple monitors or user IDs

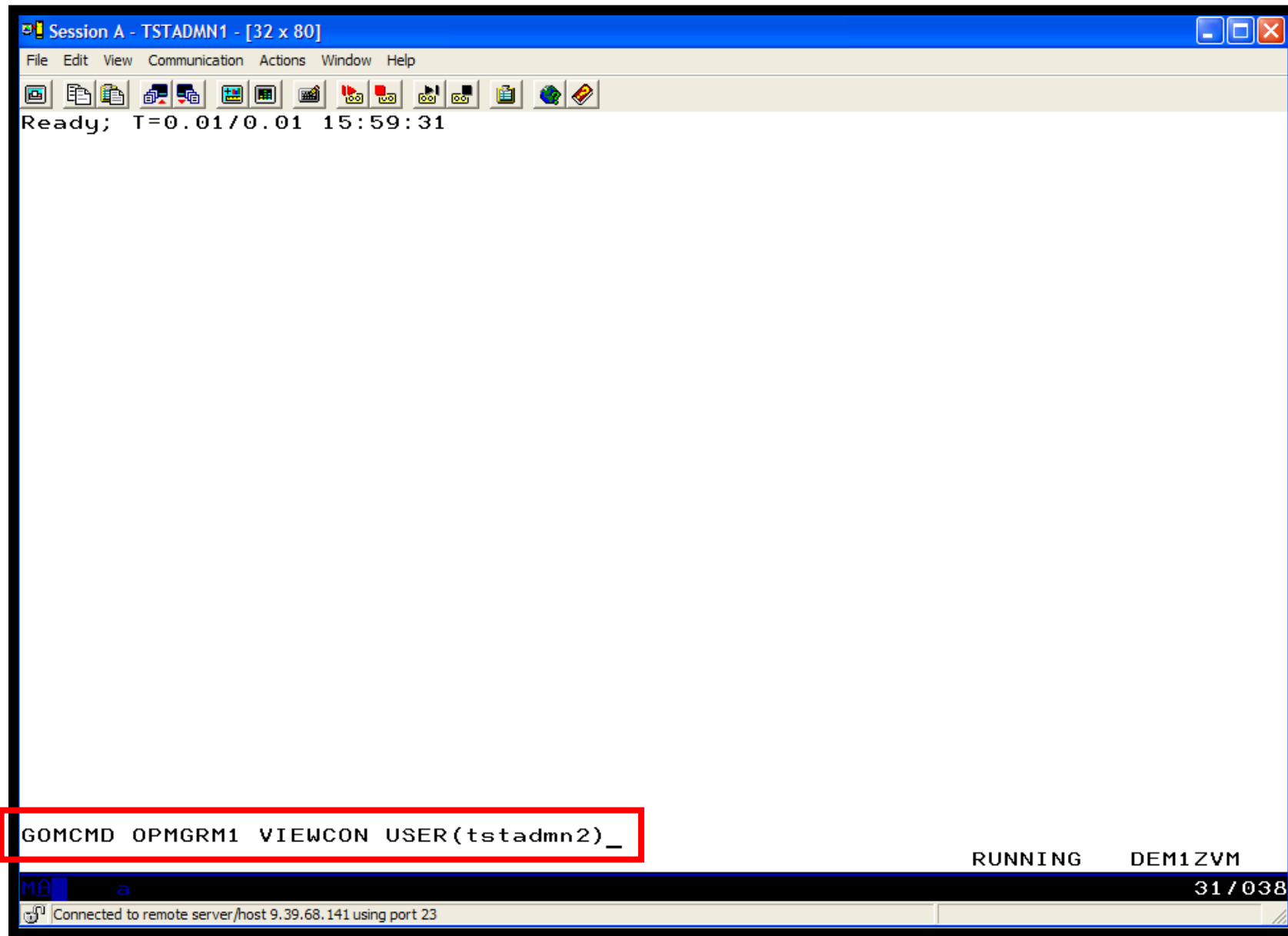

```
11:57:57 z/VM V5.4.0      2009-09-23 15:29
11:57:57 DMSACP723I C (198) R/O
11:57:57 Ready; T=0.01/0.01 11:57:57
11:58:08 CONNECT= 00:00:10 VIRTCPU= 000:00.00 TOTCPU= 000:00.00
11:58:08 LOGOFF AT 11:58:08 CST TUESDAY 03/01/11 BY MAINT
11:58:12 z/VM V5.4.0      2009-09-23 15:29
11:58:12 DMSACP723I C (198) R/O
11:58:12 Ready; T=0.01/0.01 11:58:12
11:59:35 * -- Operations Manager VIEWCON session from TSTADMN1 entered the foll
11:59:35 id
11:59:35 TSTADMN2 AT DEM1ZVM  VIA RSCS      03/01/11 11:59:35 CST      TUESDAY
11:59:35 Ready; T=0.01/0.01 11:59:35
00:00:00 HCPMID6001I  TIME IS 00:00:00 CST WEDNESDAY 03/02/11
00:00:00
00:00:00 HCPMID6001I  TIME IS 00:00:00 CST THURSDAY 03/03/11
00:00:00
```

TSTADMN2 (Scroll)

MA a 31/001

Connected to remote server/host 9.39.68.141 using port 23

```
id
MAINT AT DEM1ZVM VIA RSCS 03/03/11 16:02:56 CST THURSDAY
Ready; T=0.01/0.01 16:02:56
q tstadmn2
TSTADMN2 - DSC
Ready; T=0.01/0.01 16:04:05
force tstadmn2
USER DSC LOGOFF AS TSTADMN2 USERS = 32 FORCED BY MAINT
Ready; T=0.01/0.01 16:04:10
q tstadmn2
TSTADMN2 - DSC
Ready; T=0.01/0.01 16:04:18

RUNNING DEM1ZVM
31 / 001
Connected to remote server/host 9.39.68.141 using port 23
```

The screenshot shows a terminal window titled "Session A - TSTADMN1 - [32 x 80]". The window contains a series of system logs and status messages. A red box highlights a specific log entry: "16:04:10 CONNECT= 52:05:57 VIRTCPU= 000:00.00 TOTCPU= 000:00.00". Another red box highlights the command "TSTADMN2 (Scroll)" at the bottom right of the terminal. The terminal also shows a status bar at the bottom with "MA a" and "31 / 001", and a connection status bar at the very bottom: "Connected to remote server/host 9.39.68.141 using port 23".

```
11:57:57 z/VM V5.4.0      2009-09-23 15:29
11:57:57 DMSACP723I C (198) R/O
11:57:57 Ready; T=0.01/0.01 11:57:57
11:58:08 CONNECT= 00:00:10 VIRTCPU= 000:00.00 TOTCPU= 000:00.00
11:58:08 LOGOFF AT 11:58:08 CST TUESDAY 03/01/11 BY MAINT
11:58:12 z/VM V5.4.0      2009-09-23 15:29
11:58:12 DMSACP723I C (198) R/O
11:58:12 Ready; T=0.01/0.01 11:58:12
11:59:35 * -- Operations Manager VIEWCON session from TSTADMN1 entered the foll
11:59:35 id
11:59:35 TSTADMN2 AT DEM1ZVM  VIA RSCS      03/01/11 11:59:35 CST      TUESDAY
11:59:35 Ready; T=0.01/0.01 11:59:35
00:00:00 HCPMID6001I  TIME IS 00:00:00 CST WEDNESDAY 03/02/11
00:00:00
00:00:00 HCPMID6001I  TIME IS 00:00:00 CST THURSDAY 03/03/11
00:00:00
16:04:10 CONNECT= 52:05:57 VIRTCPU= 000:00.00 TOTCPU= 000:00.00
16:04:10 LOGOFF AT 16:04:10 CST THURSDAY 03/03/11 BY MAINT
16:04:13 z/VM V5.4.0      2009-09-23 15:29
16:04:13 DMSACP723I C (198) R/O
16:04:13 Ready; T=0.01/0.01 16:04:13

TSTADMN2 (Scroll)
```

MA a 31 / 001

Connected to remote server/host 9.39.68.141 using port 23

Scenario 12: How Do You Do That?

Console rule and action in Operations Manager:

*

```
DEFEMON NAME(ADMIN2) , +  
  TYPE(1) , +  
  USER(TSTADMN2) , +  
  ACTION(AUTOLOG1)
```

*

```
DEFACTN NAME(AUTOLOG1) , +  
  COMMAND(CP SLEEP 3 SEC) , +  
  NEXTACTN(AUTOLOG2) , +  
  OUTPUT(LOG) , +  
  ENV(OPMGRS1)
```

*

```
DEFACTN NAME(AUTOLOG2) , +  
  COMMAND(CP XAUTOLOG &3) , +  
  OUTPUT(LOG) , +  
  ENV(OPMGRS1)
```

Scenario 13: Monitor Page Space – Send Email if Full

- **Operations Manager monitors the page space usage (percent full)**
 - For demo purposes, page space monitor is currently defined but suspended (not active)
 - We'll dynamically resume (re-activate) the page space monitor
 - Demo monitor requires the page space be only 0% full
- **Usage exceeds the specified limit**
- **Automatically send an e-mail to someone who can evaluate and take action**
- **For demo purposes, suspend (de-activate) the page space monitor when complete**

Scenario 13: Detailed Steps

- **From an authorized VM user ID, see the page space usage:**

```
q alloc page
```

- **From a user ID with Operations Manager privileges:**

```
gomcmd opmgrm1 resume page(pgfull)
```

- **Check the Operations Manager log to see the spool monitor triggered:**

```
gomcmd opmgrm1 viewlog
```

- **Check the inbox of the appropriate person to see the email**

- **From a user ID with Operations Manager privileges:**

```
gomcmd opmgrm1 suspend page(pgfull)
```

MA A - DEMOADMN ATS

File Edit View Communication Actions Window Help

Host: 9.82.24.129 Port: 23 LU Name: Disconnect

```
id
DEMOADMN AT ZVMV5R40 VIA RSCS      08/07/12 15:10:02 EST      TUESDAY
Ready; T=0.017/0.01 15:10:02
q alloc page
```

VOLID	RDEV	EXTENT START	EXTENT END	TOTAL PAGES	PAGES IN USE	HIGH PAGE	% USED
540PAG	6B04	1	3338	600840	106231	141895	17%
ZVMPG1	6B05	1	3338	600840	107778	145533	17%
ZVMPG2	6B06	1	3338	600840	107866	142859	17%
ZVMPG3	6B07	1	3338	600840	105872	143574	17%
ZVMPG4	6B10	0	3338	601020	109341	146486	18%
ZVMPG5	6B0B	0	3338	601020	100116	135962	16%
ZVMPG6	6B0C	0	3338	601020	107786	147454	17%
PG6B0A	6B0A	0	10016	1761K	111151	149402	6%
SUMMARY				5869K	856141		14%
USABLE				5869K	856141		14%

```
Ready; T=0.017/0.01 15:10:06
```

RUNNING ZVMV5R40

MA A 31/001

Connected to remote server/host 9.82.24.129 using port 23

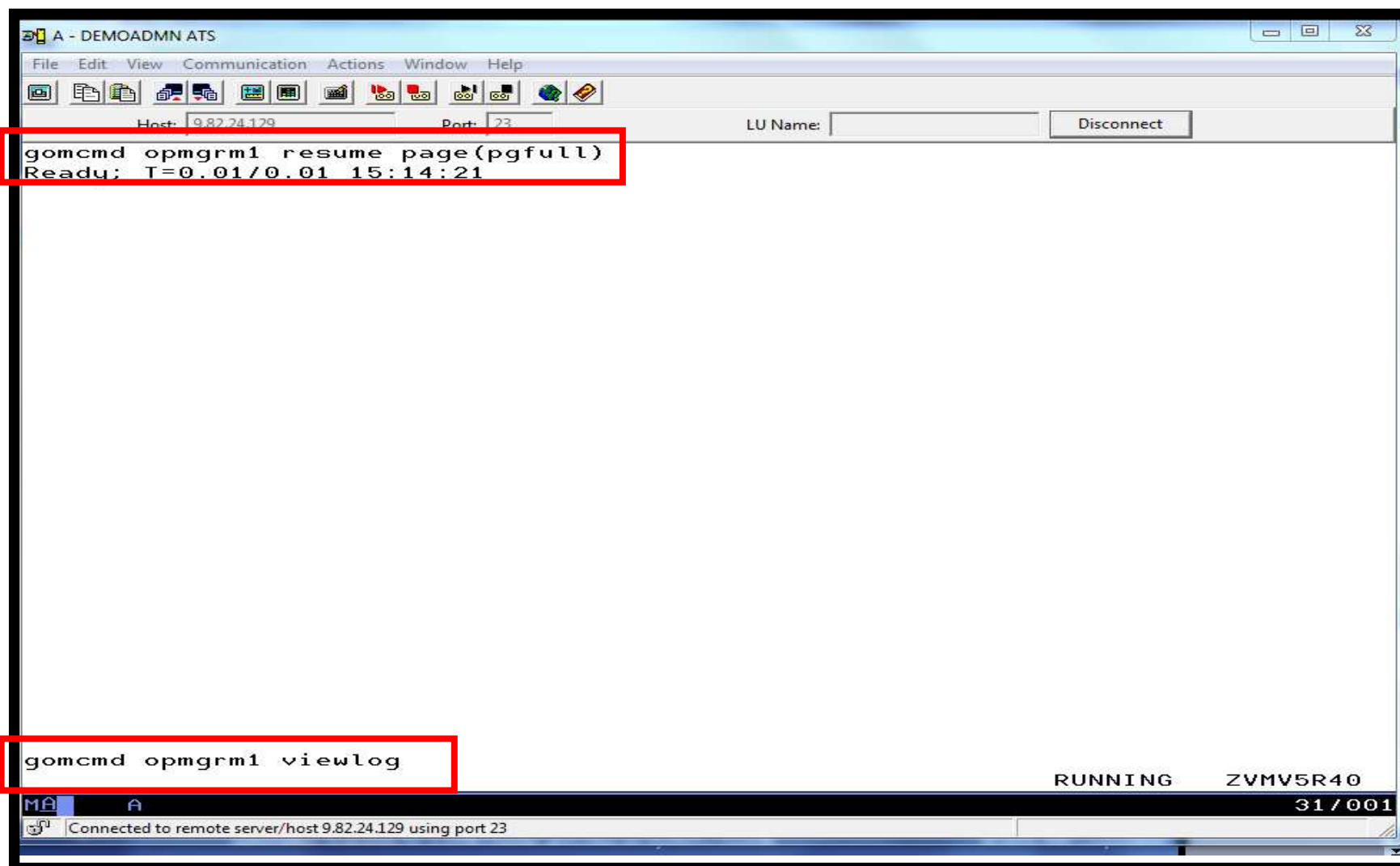

The screenshot shows a terminal window titled "A - DEMOADMN ATS". The window has a menu bar with "File", "Edit", "View", "Communication", "Actions", "Window", and "Help". Below the menu bar is a toolbar with various icons. The terminal interface includes fields for "Host: 9.82.24.129", "Port: 23", "LU Name:", and a "Disconnect" button. The main terminal area displays the following text:

```
gomcmd opmgrm1 resume page(pgfull)  
Ready: T=0.01/0.01 15:14:21
```

Below this, the command `gomcmd opmgrm1 viewlog` is entered and highlighted with a red box. The terminal status bar at the bottom right shows "RUNNING ZVMV5R40" and "31/001". The status bar at the bottom left shows "MA A" and "Connected to remote server/host 9.82.24.129 using port 23".

```

A - DEMOADMN ATS
File Edit View Communication Actions Window Help
Host: 9.82.24.129 Port: 23 LU Name: Disconnect
08/07/2012 15:15:27 GOMPM00451I PAGE USE: MONITOR PGFULL SPACE 14 PERCENT
08/07/2012 15:15:27 GOMPM00452I PAGE CHG: MONITOR PGFULL SPACE 0 PERCENT
08/07/2012 15:15:27 GOMACT0260I PAGE PGFULL ACTION PAGEMAIL TRIGGERED BY _GO
08/07/2012 15:15:27 GOMACT0262I ACTION PAGEMAIL BEGIN FOR _GOMPMON SERVER OPMG
08/07/2012 15:15:27 GOMACT0269L COMMAND "EXEC SMTPPG TLD1 AT US.IBM.COM 14"
08/07/2012 15:15:27 GOMACT0270L DMSXSU587I XEDIT:
08/07/2012 15:15:27 GOMACT0270L NOTE OPMGRM1 NOTE A1 sent to TLD1 at US.IBM.CO
08/07/2012 15:15:27 GOMACT0267I ACTION PAGEMAIL END RC=0 SERVER OPMGRM1
08/07/2012 15:15:27 GOMCMD0216L SMTP "* From SMTP: Received Spool File 005
08/07/2012 15:15:28 GOMCMD0216L SMTP "* From SMTP: Mail delivered to: <TLD
08/07/2012 15:16:20 GOMCMD0216L USSYSLOG "<30>snmpdY1425": Connection from UDP
08/07/2012 15:16:20 GOMCMD0216L LXXSYSLOG "<30>snmpdY1425": Connection from UDP
08/07/2012 15:16:27 GOMPM00453I PAGE ALERT: MONITOR PGFULL USAGE CONDITIO
08/07/2012 15:16:27 GOMPM00451I PAGE USE: MONITOR PGFULL SPACE 14 PERCENT
08/07/2012 15:16:27 GOMPM00452I PAGE CHG: MONITOR PGFULL SPACE 0 PERCENT
08/07/2012 15:16:27 GOMACT0260I PAGE PGFULL ACTION PAGEMAIL TRIGGERED BY _GO
08/07/2012 15:16:27 GOMACT0262I ACTION PAGEMAIL BEGIN FOR _GOMPMON SERVER OPMG
08/07/2012 15:16:27 GOMACT0269L COMMAND "EXEC SMTPPG TLD1 AT US.IBM.COM 14"
08/07/2012 15:16:27 GOMACT0270L DMSXSU587I XEDIT:
08/07/2012 15:16:27 GOMACT0270L NOTE OPMGRM1 NOTE A1 sent to TLD1 at US.IBM.CO
08/07/2012 15:16:27 GOMACT0267I ACTION PAGEMAIL END RC=0 SERVER OPMGRM1
08/07/2012 15:16:27 GOMCMD0216L SMTP "* From SMTP: Received Spool File 005
08/07/2012 15:16:33 GOMCMD0216L SMTP "* From SMTP: Mail delivered to: <TLD
08/07/2012 15:17:13 GOMCMD0201L DEMOADMN VIEWLOG VID=DEMOADMN SRC=HAS10CV C
08/07/2012 15:17:27 GOMPM00453I PAGE ALERT: MONITOR PGFULL USAGE CONDITIO
08/07/2012 15:17:27 GOMPM00451I PAGE USE: MONITOR PGFULL SPACE 14 PERCENT
08/07/2012 15:17:27 GOMPM00452I PAGE CHG: MONITOR PGFULL SPACE 0 PERCENT
08/07/2012 15:17:27 GOMPM00455I PAGE MONITOR "PGFULL " EXECUTION LIMIT EXCEED
PF01= SCROLL PF02= PF03= END PF04= PF05= HOLD PF06=
PF07= UP PF08= DOWN PF09= PF10= LEFT PF11= RIGHT PF12= RECALL
_GOMALOG (Scroll)
31/001
Connected to remote server/host 9.82.24.129 using port 23

```

Scenario 13: How Do You Do That?

■ Console rule and action in Operations Manager:

*

```
DEFPMON NAME (PGFULL) , +  
  USAGE (010-100) , +  
  INTERVAL (1) , +  
  LIMIT (3, 3600) , +  
  ACTION (PAGEMAIL)
```

*

```
SUSPEND PAGE (PGFULL)
```

*

```
DEFACTN NAME (PAGEMAIL) , +  
  COMMAND (EXEC SMTPPG tld1 at us.ibm.com &4) , +  
  OUTPUT (LOG) , +  
  ENV (LVM)
```

Scenario 13: How Do You Do That?

SMTPPG EXEC (excerpts)

```
/* */
Parse arg mail_user dummyat mail_node pgpct

errtext = 'Page space is' pgpct'% full on z/VM system'

/* Get local TCP/IP hostname */
parse value Search_TCPIP_Data("hostname") with getrc tcphostname .
if getrc > 4 then tcphostname = "unknown_host_name"
parse value Search_TCPIP_Data("domainorigin") with getrc tcpdomain .
if getrc > 4 then tcpdomain = "unknown_domain_name"

fqdomain_name = tcphostname '.' tcpdomain

/* Construct the e-mail */
line.1 = 'OPTIONS: NOACK    LOG    SHORT    NONOTEBOOK ALL CLASS A'
line.2 = 'Date: ' Date() ', ' Time()
line.3 = 'From: Operations Manager for z/VM'
line.4 = 'To: ' mail_user 'at' mail_node
line.5 = 'Subject: ' errtext 'on' fqdomain_name
line.6 = 'DO NOT REPLY - This e-mail was generated by an automated service machine'
line.7 = ' '
line.8 = msgtext
line.0 = 8

'PIPE stem line. | > TEMP NOTE A'

'EXEC SENDFILE TEMP NOTE A (NOTE SMTP'
```

Scenario 14:

Monitor SSI Connectivity between Two Members of a Cluster

- **Create a schedule to query ISLINKs between two members of a cluster**
- **If less than 4 links up, send message to consolidated SSI console (OPERSSI)**
 - For demo purposes, we'll dynamically deactivate a link then reactivate it when done

Scenario 14: Detailed Steps

- **From an authorized VM user ID, see the currently available ISLINKs:**

```
q islink node testcssi
```

- **Deactivate one of the links:**

```
deactivate islink 0d01
```

- **Using Operations Manager, view the central operations console to see the alert:**

```
gomcmd opmgrm1 viewcon user(operssi)
```

- **Schedule is triggered every 2 minutes, so wait 2 minutes and see the messages again**
- **Reactivate the link:**

```
activate islink 0d01
```

Scenario 14: How Do You Do That?

■ Schedule and action in Operations Manager:

*** Check every 10 minutes for any IS links being down

```
DEFSCHD NAME(ISLINK1),+
```

```
EVERY(00:02),+
```

```
ACTION(QISLINK),+
```

```
PARM(TESTCSSI)
```

*

```
DEFACTN NAME(QISLINK),+
```

```
COMMAND(EXEC QISLINK TEST7SSI &p),+
```

```
ENV(SVM)
```

Scenario 14: How Do You Do That?

■ QISLINK EXEC:

```
/* Find the number of IS Links available to another node */
/* If less than 4, then send message to OPERSSI */
trace o
Address command
Parse Arg thisnode othernode
'PIPE CP QUERY ISLINK NODE' othernode '| find ____State:____Up| COUNT LINES | VAR numlinks'
If numlinks < 4
  Then 'CP MSGNOH OPERSSI AT TEST7SSI From' thisnode': Number of ISLINKs to' othernode 'is' numlinks
Exit 0
```

Scenario 15: Suppress Passwords on Linux Consoles

- **TN3270 login to Linux guest displays password**
 - Password on separate line from password prompt
 - Password captured in console and viewable in Operations Manager VIEWCON
- **Use a rule in Operations Manager to suppress the password**
 - I.e. the line following the “password:” prompt
- **Can be expanded to suppress multiple lines following matching text**

Scenario 15: Detailed Steps

- **Use Operations Manager to view the console of a Linux guest:**

```
gomcmd opmgrml viewcon user(omeglnx1)
```

- **Enter the login command:**

```
login root
```

- **Enter the password**
 - Note that it's not displayed

Scenario 15: How Do You Do That?

■ Rule and action in Operations Manager:

- *
* Change password prompt to red.
- * Suppress the password when logging onto OMEGLNX1.
- * Have to suppress next 2 lines to include the line Ops Mgr adds
- * indicating the user entered a "command"
- *

```
DEFRULE NAME(OMEGPW),+  
  MATCH(Password:*) ,+  
  USER(OMEGLN1) ,+  
  ACTION(SUPPW) ,+  
  SUPNEXT(2)
```

*

```
DEFACTN NAME(SUPPW) ,+  
  INPUT(CRE)
```

Scenario 16:

Autolog a Linux Guest and Send Message if Doesn't Start Successfully

- **Define a schedule and action to start a Linux guest**
- **Define a rule looking for the application specific message indicating up and ready for work**
- **Define an idle monitor for the above rule**
 - If “up and ready” message is not found within 1 minute, then send message to central console
- **Idle monitor is suspended until schedule is triggered**
 - Before autologging the Linux guest, automatically resume idle monitor
- **Idle monitor is automatically suspended again once it is triggered**

Scenario 16: Detailed Steps

- **View the configuration file to see the action that will be “scheduled”, plus the rules and monitors**

```
x tracy config
```

- **Run the action that starts the guest (and monitors)**

```
gomcmd opmgrml run action(strtlnx1)
```

- **View the console of LNXTEST to see that it gets autologged**

```
gomcmd opmgrml viewcon user(lnxtest)
```

- **View the central console of OPERSSI to see the message that the guest did not start successfully**

```
gomcmd opmgrml viewcon user(operssi)
```

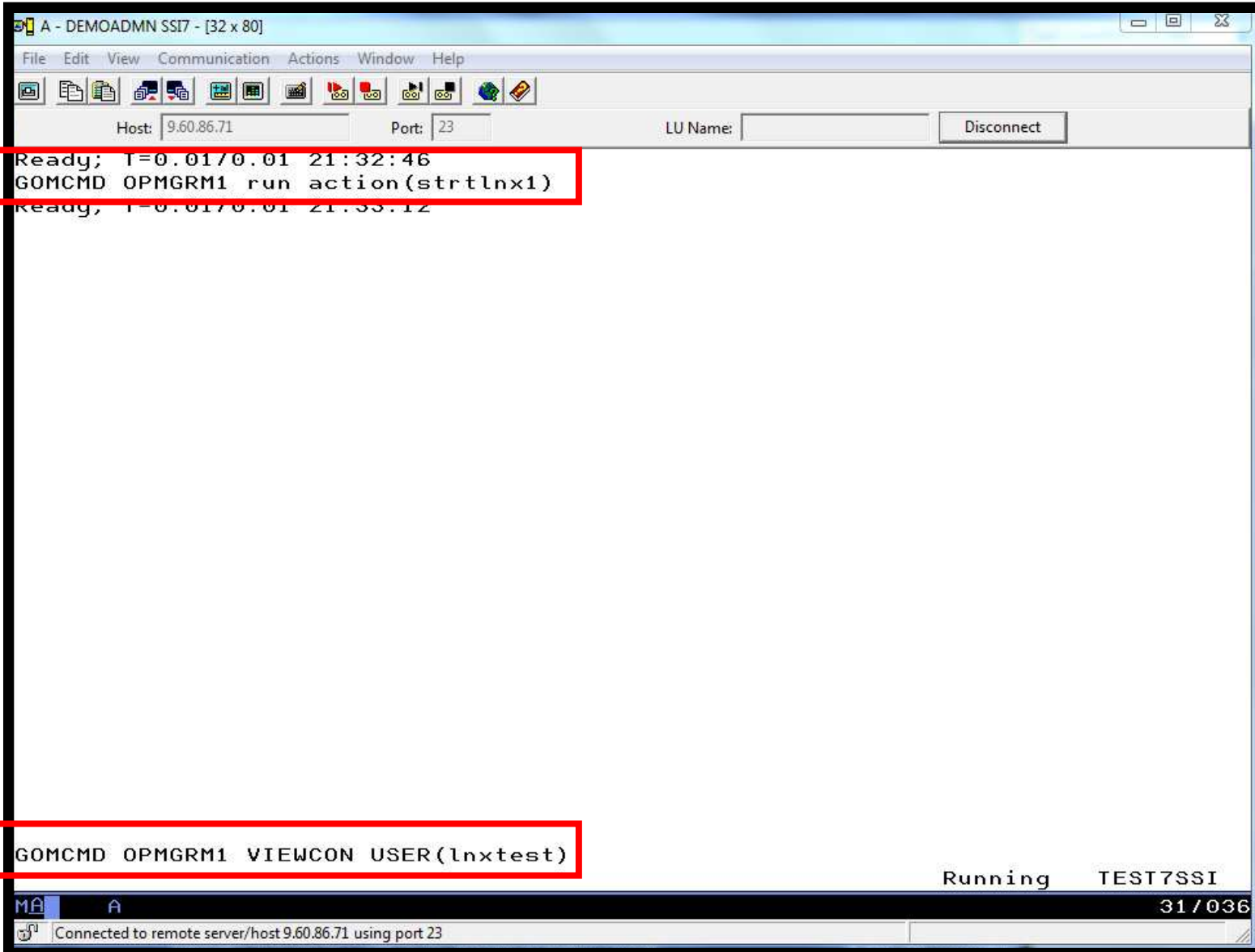

The screenshot shows a terminal window titled "A - DEMOADMN SSI7 - [32 x 80]". The window has a menu bar with "File", "Edit", "View", "Communication", "Actions", "Window", and "Help". Below the menu bar is a toolbar with various icons. The terminal interface includes fields for "Host: 9.60.86.71", "Port: 23", and "LU Name: ". A "Disconnect" button is located to the right of the "LU Name" field. The terminal output shows the following text:

```
Ready; T=0.01/0.01 21:32:46  
GOMCMD OPMGRM1 run action(strltx1)  
Ready; T=0.01/0.01 21:33:12
```

At the bottom of the terminal, the command "GOMCMD OPMGRM1 VIEWCON USER(lnxtest)" is shown, followed by the status "Running TEST7SSI". The bottom status bar of the terminal displays "MA A" on the left, "31 / 036" on the right, and "Connected to remote server/host 9.60.86.71 using port 23" at the bottom.

```

A - DEMOADMN SSI7 - [32 x 80]
File Edit View Communication Actions Window Help
Host: 9.60.86.71 Port: 23 LU Name: Disconnect
21:24:45 DMSDCT104S Error 3 reading file SYSTEM SEGID S2
21:24:45 DMSINS327I The installation saved segment CMSINST could not be loaded
21:24:45 DMSINS313W SYSPROF EXEC not found; notify system administrator
21:24:45 DMSOPN002E File SCOMDIR NAMES * not found
21:24:45 DMSSEC1286E Error loading SYSTEM Communications Directory, fileid = SC
21:24:45 DMSSEC639E Error in NAMEFIND routine; return code was 28
21:24:45 z/VM V6.2.0 2012-12-11 15:49
21:24:45 DMSINS100W Shared Y-STAT not available
21:24:45 * MSG FROM LNXTEST : DMSINS2563T RTNLOAD failed for VMMLIB
21:24:45 HCPGIR450W CP entered; disabled wait PSW 000A0000 800214EE
21:32:40 * -- Operations Manager VIEWCON session from DEMOADMN entered the foll
21:32:40 logoff
21:32:40 CONNECT= 00:07:53 VIRTCPU= 000:00.00 TOTCPU= 000:00.00
21:32:40 LOGOFF AT 21:32:40 EDT TUESDAY 07/16/13
21:32:42 * -- Operations Manager VIEWCON session from DEMOADMN entered the foll
21:32:42 cp logoff
21:33:15 DMSIND2015W Unable to access system disk. Filemode S (190) not accesse
21:33:15 DMSIND2015W Unable to access the Y-disk. Filemode Y (19E) not accessed
21:33:15 DMSDCT104S Error 3 reading file SYSTEM SEGID S2
21:33:15 DMSINS327I The installation saved segment CMSINST could not be loaded
21:33:15 DMSINS313W SYSPROF EXEC not found; notify system administrator
21:33:15 DMSOPN002E File SCOMDIR NAMES * not found
21:33:15 DMSSEC1286E Error loading SYSTEM Communications Directory, fileid = SC
21:33:15 DMSSEC639E Error in NAMEFIND routine; return code was 28
21:33:15 z/VM V6.2.0 2012-12-11 15:49
21:33:15 DMSINS100W Shared Y-STAT not available
21:33:15 * MSG FROM LNXTEST : DMSINS2563T RTNLOAD failed for VMMLIB
21:33:15 HCPGIR450W CP entered; disabled wait PSW 000A0000 800214EE
PF01= SCROLL PF02= PF03= END PF04= PF05= HOLD PF06= FORMAT
PF07= UP PF08= DOWN PF09= PF10= LEFT PF11= RIGHT PF12= RECALL
LNXTST (Scroll)
MA A 317001
Connected to remote server/host 9.60.86.71 using port 23

```

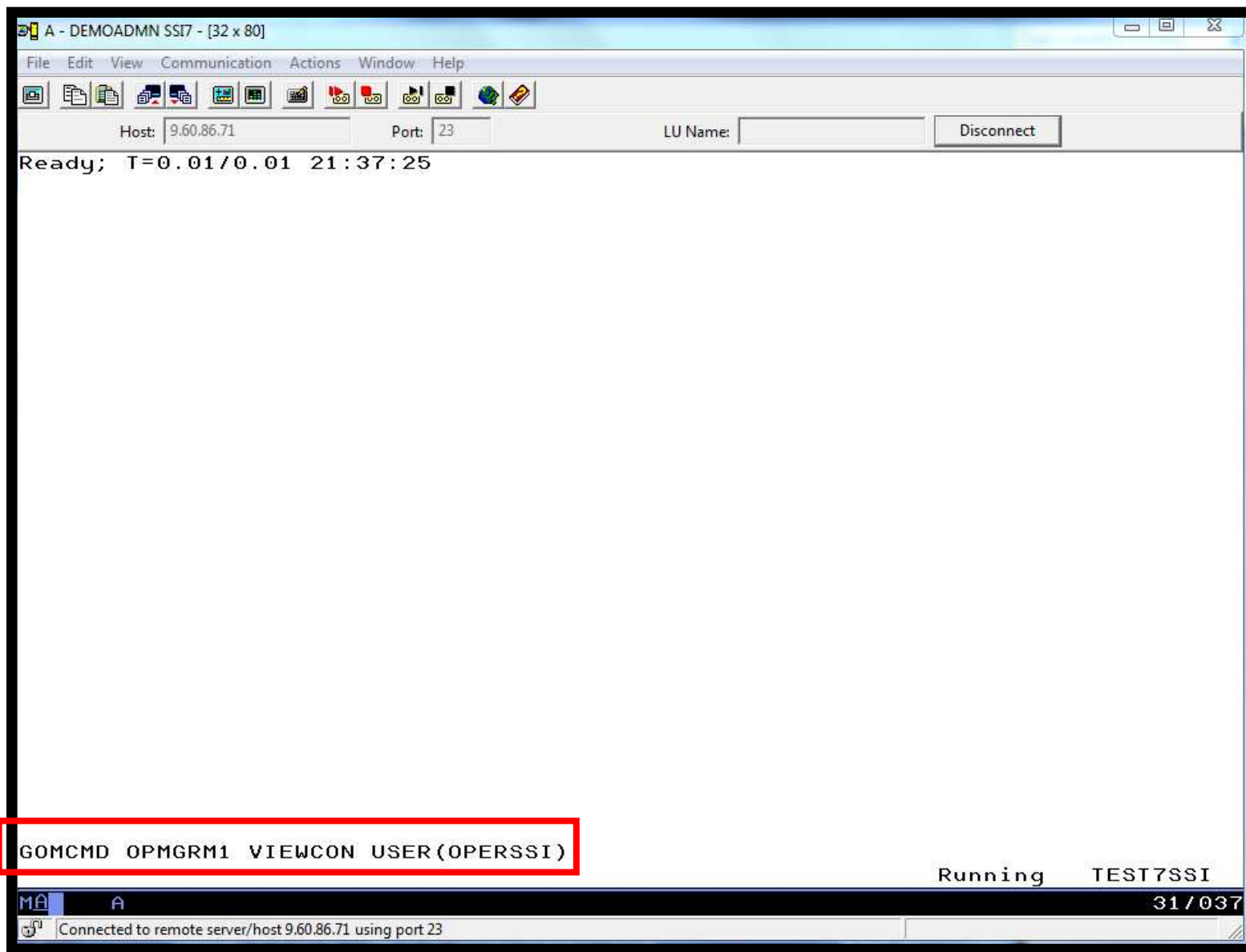

```
A - DEMOADMN SSI7 - [32 x 80]
File Edit View Communication Actions Window Help
Host: 9.60.86.71 Port: 23 LU Name: Disconnect
00:00:00 HCPMID6001I TIME IS 00:00:00 EDT TUESDAY 07/09/13
00:00:00
00:00:00 HCPMID6001I TIME IS 00:00:00 EDT WEDNESDAY 07/10/13
00:00:00
00:00:00 HCPMID6001I TIME IS 00:00:00 EDT THURSDAY 07/11/13
00:00:00
00:00:00 HCPMID6001I TIME IS 00:00:00 EDT FRIDAY 07/12/13
00:00:00
00:00:00 HCPMID6001I TIME IS 00:00:00 EDT SATURDAY 07/13/13
00:00:00
00:00:00 HCPMID6001I TIME IS 00:00:00 EDT SUNDAY 07/14/13
00:00:00
00:00:00 HCPMID6001I TIME IS 00:00:00 EDT MONDAY 07/15/13
00:00:00
00:00:00 HCPMID6001I TIME IS 00:00:00 EDT TUESDAY 07/16/13
00:00:00
20:58:15 From DEMOADM2 on TEST7SSI : COMPLETE STARTUP
20:59:15 From DEMOADM2 on TEST7SSI : COMPLETE STARTUP
21:00:15 From DEMOADM2 on TEST7SSI : COMPLETE STARTUP
21:01:15 From DEMOADM2 on TEST7SSI : COMPLETE STARTUP
21:02:15 From DEMOADM2 on TEST7SSI : COMPLETE STARTUP
21:03:15 From DEMOADM2 on TEST7SSI : COMPLETE STARTUP
21:04:15 From DEMOADM2 on TEST7SSI : COMPLETE STARTUP
21:05:15 From DEMOADM2 on TEST7SSI : COMPLETE STARTUP
21:07:15 DEMOADM2 DID NOT SUCCESSFULLY COMPLETE STARTUP
21:23:15 LNXTST DID NOT SUCCESSFULLY COMPLETE STARTUP
21:25:15 LNXTST DID NOT SUCCESSFULLY COMPLETE STARTUP
21:33:15 LNXTST DID NOT SUCCESSFULLY COMPLETE STARTUP
PF01= SCROLL PF02= PF03= END PF04= PF05= HOLD PF06= FORMAT
PF07= UP PF08= DOWN PF09= PF10= LEFT PF11= RIGHT PF12= RECALL
OPERSSI (Scroll)
MA A 317001
Connected to remote server/host 9.60.86.71 using port 23
```

Scenario 16: How Do You Do That?

Schedule and action in Operations Manager:

```
*DEFSCHD NAME(STARTLN),+
*  WHEN(00:01),+
*  ACTION(STRTLNX1)
*
DEFACTN NAME(STRTLNX1),+
  COMMAND('RESUME IDLE(NOLOGON)'),+
  NEXTACTN(STRTLNX2),+
  ENV(GOM)
*
DEFACTN NAME(STRTLNX2),+
  COMMAND(CP XAUTOLOG LNXTEST),+
  ENV(SVM)
```

Scenario 16: How Do You Do That?

- **Watch for successful startup of Linux guest**
- **If successful take no action**

```
DEFRULE NAME(LNXLOGON),+  
    MATCH(*LNXTEST successfully started*),+  
    USER(LNXTEST),+  
    ACTION(NOACT)  
*  
DEFACTN NAME(NOACT)
```

Scenario 16: How Do You Do That?

- **If Linux doesn't start successfully send message to central console and suspend monitor:**

```
DEFIMON NAME(NOLOGON),+
  RULE(LNXLOGON),+
  OCCUR(1,1),+
  ACTION(MSG2SSI2),+
  PARM(LNXTEST)
*
SUSPEND IDLE(NOLOGON)
DEFACTN NAME(MSG2SSI2),+
  COMMAND(CP MSGNOH OPERSSI &p did not successfully complete startup),+
  NEXTACTN(SUSPIDLE),+
  ENV(SVM)
*
DEFACTN NAME(SUSPIDLE),+
  COMMAND('SUSPEND IDLE(NOLOGON)'),+
  ENV(GOM)
```

Scenario 17: View Live Consoles of Linux Guests, Linux Syslog Data, CMS Service Machines

- **Configure user IDs / guests to be monitored by Operations Manager**
- **Route syslog data from a Linux guest to Operations Manager**
- **From authorized user, view the live console data of**
 - OPERATOR
 - Issue VM commands
 - A Linux guest
 - Issue Linux commands
 - Linux syslog data

Scenario 17: Detailed Steps

- **From an authorized VM user ID, verify OPERATOR and Linux guest are being monitored by Operations Manager**

```
q secuser operator
```

```
q observer sles11c
```

- **View the console of OPERATOR**

```
gomcmd opmgrm1 viewcon user(operator)
```

- **Issue VM commands allowed by OPERATOR**

```
id
```

```
cp send bkrbkup cms listfile
```

- **View the console of the backup server**

```
gomcmd opmgrm1 viewcon user(bkrbkup)
```

- **View the console of a Linux guest and issue Linux commands**

```
gomcmd opmgrm1 viewcon user(sles11c)
```

```
echo hello world
```

- **View the syslog data from a Linux guest**

```
gomcmd opmgrm1 viewcon user(lxsyslog)
```

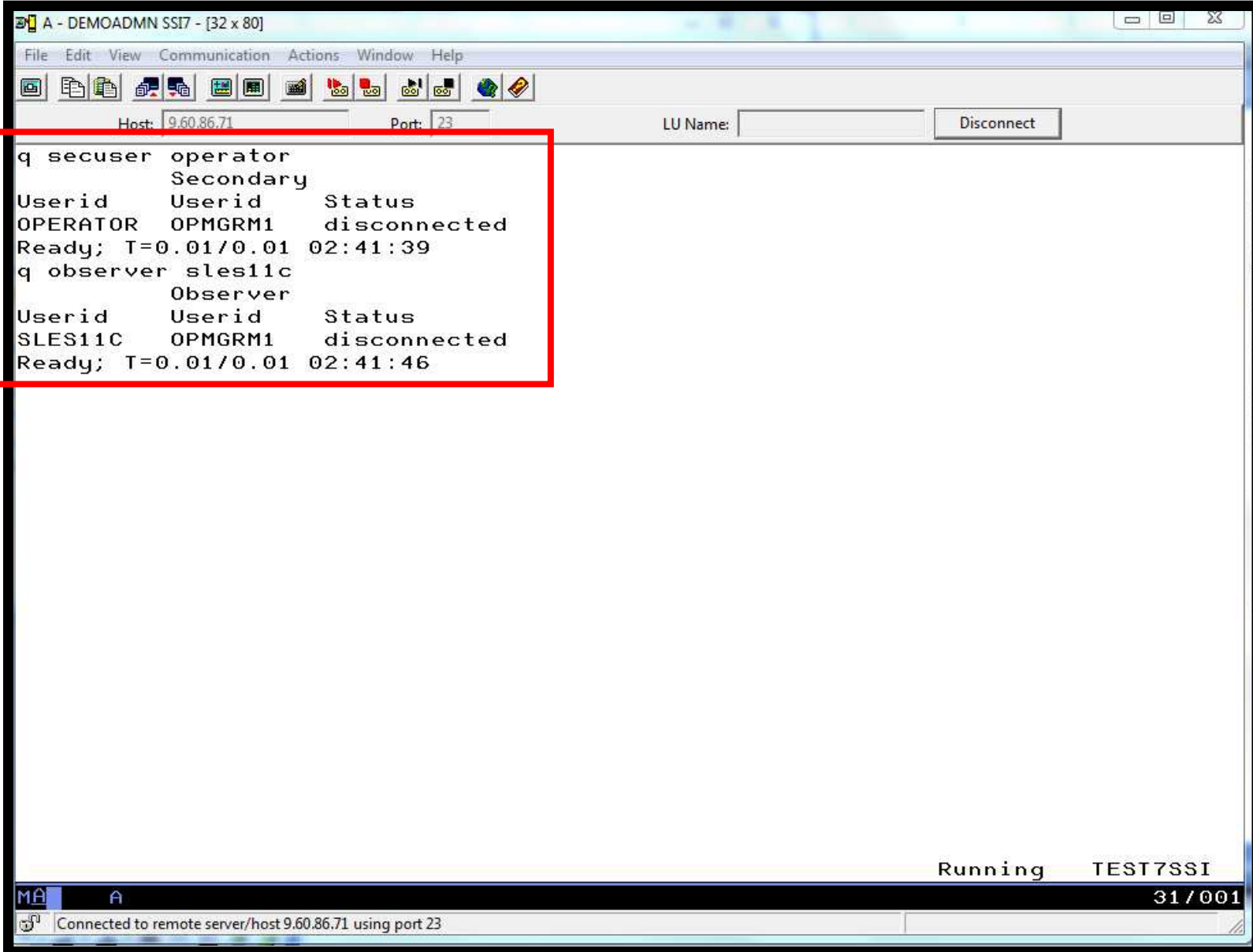

A screenshot of a terminal window titled "A - DEMOADMN SSI7 - [32 x 80]". The window has a menu bar (File, Edit, View, Communication, Actions, Window, Help) and a toolbar. Below the toolbar, there are input fields for "Host: 9.60.86.71", "Port: 23", and "LU Name:". A "Disconnect" button is located to the right of the LU Name field. The main area of the terminal displays the following text:

```
q secuser operator
      Secondary
Userid  Userid  Status
OPERATOR OPMGRM1 disconnected
Ready; T=0.01/0.01 02:41:39
q observer sles11c
      Observer
Userid  Userid  Status
SLES11C OPMGRM1 disconnected
Ready; T=0.01/0.01 02:41:46
```

A red rectangular box highlights the text from the first "q" command to the second "Ready" line. At the bottom right of the terminal, it says "Running TEST7SSI". The status bar at the very bottom shows "MA A" on the left, "31 / 001" on the right, and "Connected to remote server/host 9.60.86.71 using port 23" in the center.

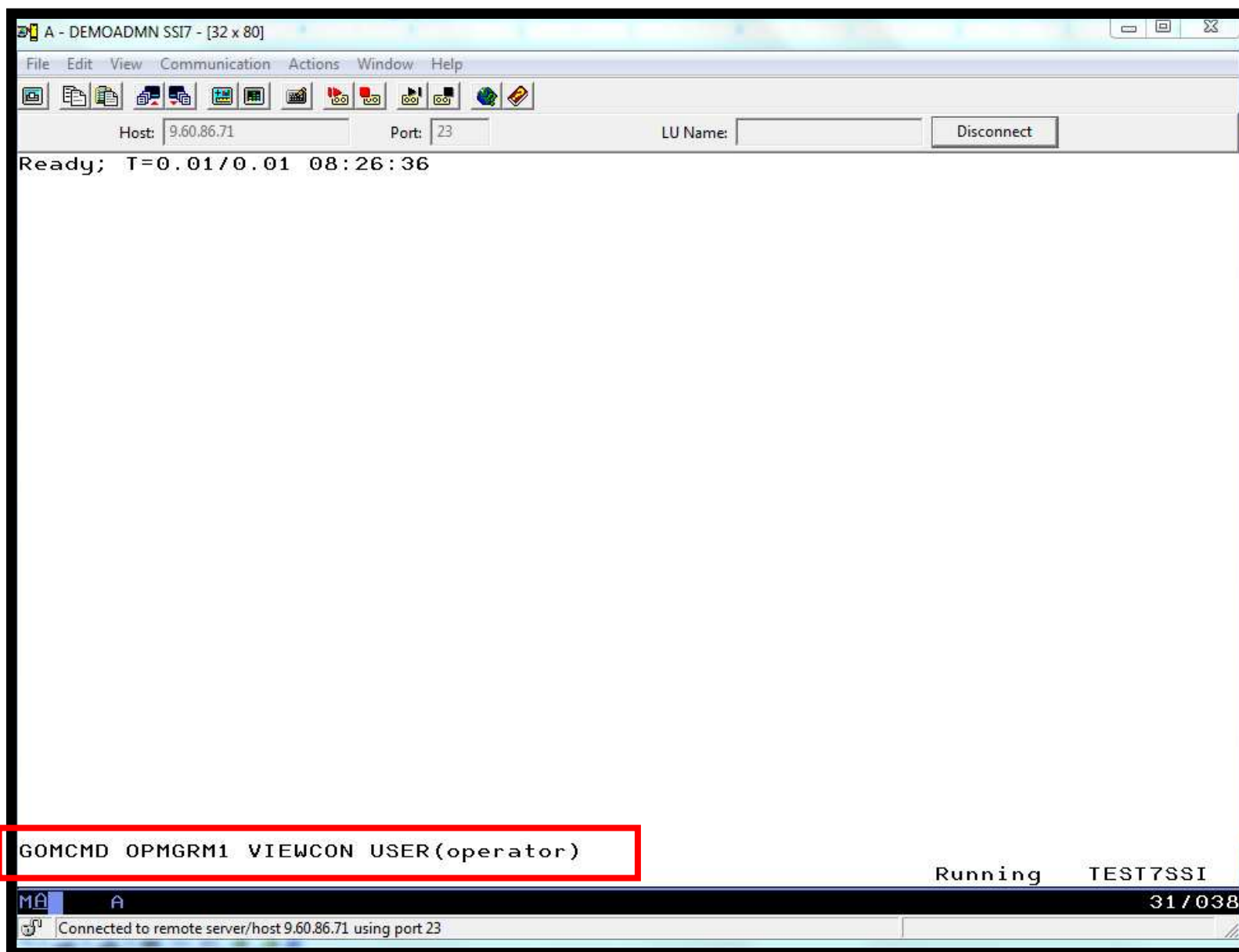

```

A - DEMOADMN SSI7 - [32 x 80]
File Edit View Communication Actions Window Help
Host: 9.60.86.71 Port: 23 LU Name: Disconnect
00:01:04 DVHDLY3882I Daily processing started.
00:01:04 DVHDLY3885I Daily processing completed.
00:01:23 * MSG FROM PERFSVM : FCXPMN444E IUCV reply failed with reason code 9
00:01:23 * -- Operations Manager Action EXEC scheduled for execution -- *
00:02:01 DVHBCK3871I Disk backup processing started.
00:02:01 DVHBCK3872I Disk backup part 1 completed.
00:02:01 DVHBCK3872I Disk backup part 2 started.
00:02:01 DVHBCK3873I Disk backup processing completed.
00:15:00 HPCPCRC8064I Recording data retrieval has been started; recording *ACCO
00:20:03 AUTO LOGON *** RACFSMF USERS = 39 BY OPMGRS3
00:20:03 * MSG FROM RACFSMF : SMF Switch has been attempted for RACFVM
00:20:03 * MSG FROM RACFSMF : SMF DATA F for RACFVM copied to RACFSMF SMF13161
00:20:03 * MSG FROM RACFSMF : RACFSMF SMF DATA F Moved to RACFSMF SMF DATA A
00:20:03 USER DSC LOGOFF AS RACFSMF USERS = 38
00:25:03 OPMGRS3: DMSCYS2452I SFPURGER starting at 00:25:03 on 10 Jun 2013.
00:25:03 OPMGRS3: DMSCYS2453I Running in RUN mode - RUN13161.
00:25:03 OPMGRS3: DMSCYS2456I Erasing old output files till 2013147.
00:25:03 OPMGRS3: DMSCYS2459I Examining output file ...
00:25:03 OPMGRS3: DMSCYS2462I Spool file scanning begins ...
00:25:03 OPMGRS3: DMSCYS2463I 0 of the 120 spool files HAVE been purged.
00:25:03 OPMGRS3: DMSCYS2485I 0 of the 120 spool files HAVE been changed.
00:25:03 OPMGRS3: DMSCYS2486I 11 of the 120 spool files HAVE been handled by us
00:25:03 OPMGRS3: DMSCYS2466I Run terminating - Return code 0.
00:25:03 OPMGRS3: DMSCYS2465I SFPURGER RUN13161 has ended.
08:12:31 GRAF L0005 LOGON AS DEMOADMN USERS = 39 FROM 9.65.0.71
08:22:47 ICH408I USER(MAINT ) GROUP(SYS1 ) NAME(#####)
08:22:47 LOGON/JOB INITIATION - INVALID PASSWORD ENTERED AT TERMINAL LOGL0006
08:22:49 GRAF L0006 LOGON AS MAINT USERS = 40
PF01= SCROLL PF02= PF03= END PF04= PF05= HOLD PF06= FORMAT
PF07= UP PF08= DOWN PF09= PF10= LEFT PF11= RIGHT PF12= RECALL
OPERATOR (Scroll)
MA A 317001
Connected to remote server/host 9.60.86.71 using port 23

```



```

A - DEMOADMN SSI7 - [32 x 80]
File Edit View Communication Actions Window Help
Host: 9.60.86.71 Port: 23 LU Name: Disconnect
10:13:42 SMTP - DSC , TCPIP - DSC , DTCVSW2 - DSC , DTCVSW1 - DSC
10:13:42 OPERATNS - DSC , ATSSERV - DSC , VMSEVR - DSC , VMSERVU - DSC
10:13:42 VMSERVP - DSC , VMSERVS - DSC , RACFVM - DSC , OPERSYMP - DSC
10:13:42 DISKACNT - DSC , EREP - DSC , OPERATOR - DSC
10:13:42 VSM - TCPIP
10:13:42 Ready; T=0.01/0.01 10:13:42
10:13:48 * -- Operations Manager VIEWCON session from DEMOADMN entered the foll
10:13:48 q disk
10:13:48 LABEL VDEV M STAT CYL TYPE BLKSZ FILES BLKS USED-(%) BLKS LEFT
10:13:48 OPR191 191 A R/W 5 3390 4096 4 11-01 889
10:13:48 OP1191 192 D R/O 1 3390 4096 4 11-06 169
10:13:48 MNT190 190 S R/O 207 3390 4096 694 18264-49 18996
10:13:48 MNT19E 19E Y/S R/O 500 3390 4096 1181 30149-33 59851
10:13:48 Ready; T=0.01/0.01 10:13:48
10:13:53 * -- Operations Manager VIEWCON session from DEMOADMN entered the foll
10:13:53 listfile * * d
10:13:53 PROFILE EXEC D1
10:13:53 PROFILE XEDIT D1
10:13:53 SYN SYNONYM D1
10:13:53 TEST OP1 D1
10:13:53 Ready; T=0.01/0.01 10:13:53
10:14:03 * -- Operations Manager VIEWCON session from DEMOADMN entered the foll
10:14:03 id
10:14:03 OPERATOR AT TEST7SSI VIA RSCS 06/10/13 10:14:03 EDT MONDAY
10:14:03 Ready; T=0.01/0.01 10:14:03
10:14:17 * -- Operations Manager VIEWCON session from DEMOADMN entered the foll
10:14:17 cp send bkrbkup cms listfile
10:14:17 Ready; T=0.01/0.01 10:14:17
PF01= SCROLL PF02= PF03= END PF04= PF05= HOLD PF06= FORMAT
PF07= UP PF08= DOWN PF09= PF10= LEFT PF11= RIGHT PF12= RECALL
OPERATOR (Scroll)
MA A 317001
Connected to remote server/host 9.60.86.71 using port 23

```

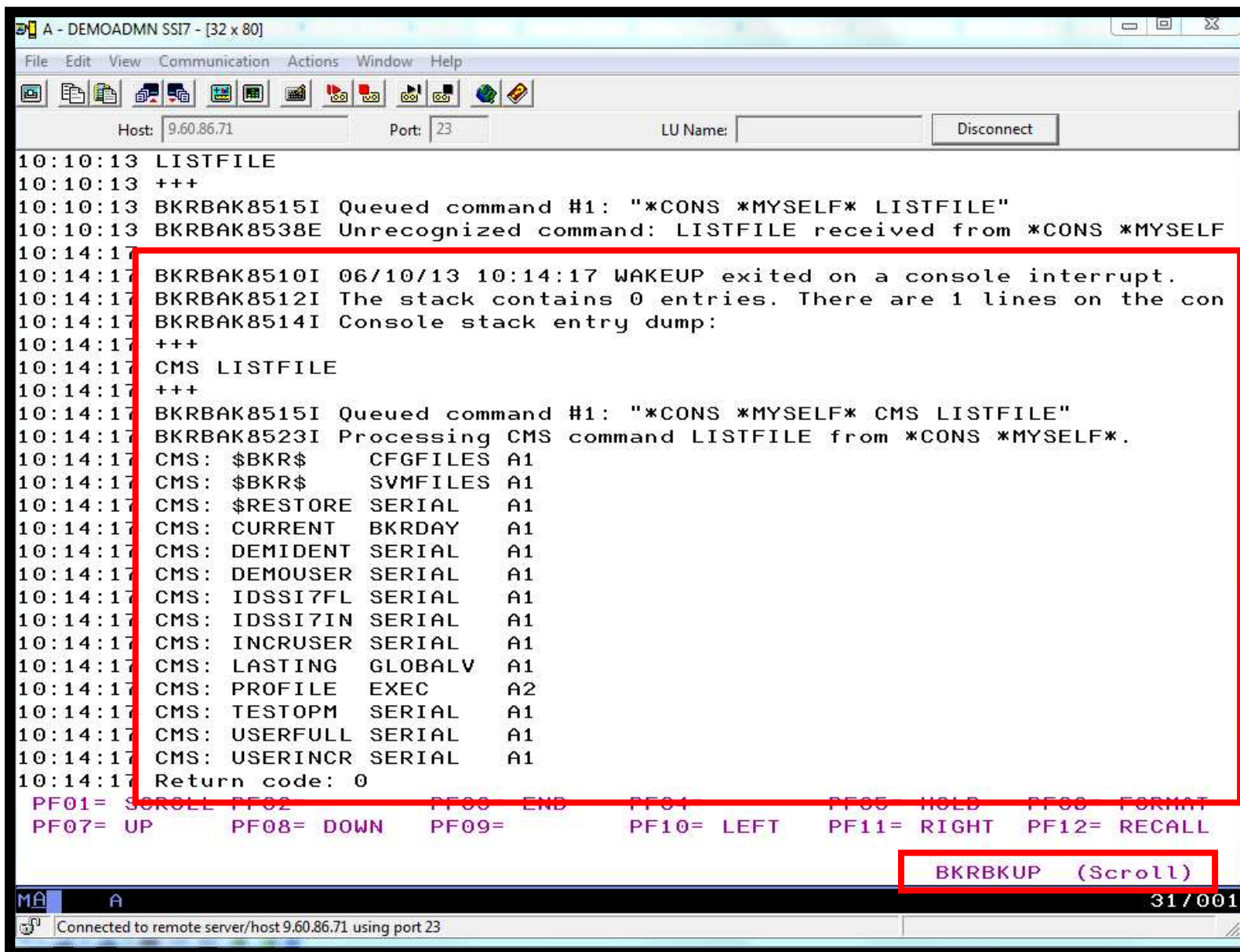

```
A - DEMOADMN SSI7 - [32 x 80]
File Edit View Communication Actions Window Help
Host: 9.60.86.71 Port: 23 LU Name: Disconnect
10:10:13 LISTFILE
10:10:13 +++
10:10:13 BKRBAK8515I Queued command #1: "*CONS *MYSELF* LISTFILE"
10:10:13 BKRBAK8538E Unrecognized command: LISTFILE received from *CONS *MYSELF*
10:14:17 BKRBAK8510I 06/10/13 10:14:17 WAKEUP exited on a console interrupt.
10:14:17 BKRBAK8512I The stack contains 0 entries. There are 1 lines on the con
10:14:17 BKRBAK8514I Console stack entry dump:
10:14:17 +++
10:14:17 CMS LISTFILE
10:14:17 +++
10:14:17 BKRBAK8515I Queued command #1: "*CONS *MYSELF* CMS LISTFILE"
10:14:17 BKRBAK8523I Processing CMS command LISTFILE from *CONS *MYSELF*.
10:14:17 CMS: $BKR$ CFGFILES A1
10:14:17 CMS: $BKR$ SVMFILES A1
10:14:17 CMS: $RESTORE SERIAL A1
10:14:17 CMS: CURRENT BKRDAY A1
10:14:17 CMS: DEMIDENT SERIAL A1
10:14:17 CMS: DEMOUSER SERIAL A1
10:14:17 CMS: IDSSI7FL SERIAL A1
10:14:17 CMS: IDSSI7IN SERIAL A1
10:14:17 CMS: INCRUSER SERIAL A1
10:14:17 CMS: LASTING GLOBALV A1
10:14:17 CMS: PROFILE EXEC A2
10:14:17 CMS: TESTOPM SERIAL A1
10:14:17 CMS: USERFULL SERIAL A1
10:14:17 CMS: USERINCR SERIAL A1
10:14:17 Return code: 0
PF01= SCROLL PF02= END PF03= END PF04= HOLD PF05= HOLD PF06= FORMAT
PF07= UP PF08= DOWN PF09= PF10= LEFT PF11= RIGHT PF12= RECALL
BKRBKUP (Scroll)
MA A 31/001
Connected to remote server/host 9.60.86.71 using port 23
```



```

A - DEMOADMN SSI7 - [32 x 80]
File Edit View Communication Actions Window Help
Host: 9.60.86.71 Port: 23 LU Name: Disconnect
11:40:31 0.0.1e00: Device is a Guest LAN QDIO card (level: V622)
11:40:31 with link type GuestLAN QDIO (portname: X)
11:40:31 Jun 10 11:40:31 sles11c kernel: qeth.3acf0c: 0.0.1e00: The qeth device
11:40:31 Jun 10 11:40:31 sles11c kernel: qeth: irb 00000000: 00 c2 40 17 1d 41
11:40:31 Jun 10 11:40:31 sles11c kernel: qeth: irb 00000010: 01 02 00 00 00 00
11:40:31 qeth.47953b: 0.0.1e00: Hardware IP fragmentation not supported on eth0
11:40:31 Jun 10 11:40:31 sles11c kernel: qeth: sense data 00000000: 02 00 00 00
11:40:31 0.0.1e00: Inbound source MAC-address not supported on eth0
11:40:31 Jun 10 11:40:31 sles11c kernel: qeth: sense data 00000010: 00 00 00 00
11:40:31 Jun 10 11:40:31 sles11c kernel: qeth.3acf0c: 0.0.1e00: The qeth device
11:40:31 Jun 10 11:40:31 sles11c kernel: qeth: irb 00000000: 00 c2 40 17 1d 41
11:40:31 qeth.d7fdb4: 0.0.1e00: VLAN enabled
11:40:31 Jun 10 11:40:31 sles11c kernel: qeth: irb 00000010: 01 02 00 00 00 00
11:40:31 Jun 10 11:40:31 sles11c kernel: qeth: irb 00000020: 02 00 00 00 00 00
11:40:31 Jun 10 11:40:31 sles11c kernel: qeth: irb 00000030: 00 00 00 00 00 00
11:40:31 qeth.e90c78: 0.0.1e00: Multicast enabled
11:40:31 Jun 10 11:40:31 sles11c kernel: qeth.fd0b7c: 0.0.1e00: A recovery proc
11:40:31 qeth.5a9d02: 0.0.1e00: IPV6 enabled
11:40:31 qeth.184d8a: 0.0.1e00: Broadcast enabled
11:40:31 qeth.dac2aa: 0.0.1e00: Using SW checksumming on eth0.
11:40:31 qeth.9c4c89: 0.0.1e00: Outbound TSO not supported on eth0
11:40:31 qeth.bad88b: 0.0.1e00: Device successfully recovered!
11:40:31 Jun 10 11:40:31 sles11c kernel: with link type GuestLAN QDIO (portname: X)
11:41:23 * -- Operations Manager VIEWCON session from DEMOADMN entered the foll
11:41:23 echo hello world
11:41:23 echo hello world
11:41:23 hello world
11:41:23 sles11c:~ #
PF01= SCROLL PF02= PF03= END PF04= PF05= HOLD PF06= FORMAT
PF07= UP PF08= DOWN PF09= PF10= LEFT PF11= RIGHT PF12= RECALL
SLES11C (Scroll)
MA A 31/001
Connected to remote server/host 9.60.86.71 using port 23

```

```

Host: 9.60.86.71      Port: 23      LU Name:      Disconnect
04:37:26 <46>Jun 10 04:37:26 sles11d -- MARK --.
04:57:26 <46>Jun 10 04:57:26 sles11d -- MARK --.
05:17:26 <46>Jun 10 05:17:26 sles11d -- MARK --.
05:17:26 <46>Jun 10 05:17:26 sles11d syslog-ngY53012": Log statistics; dropped=
05:37:26 <46>Jun 10 05:37:26 sles11d -- MARK --.
05:57:26 <46>Jun 10 05:57:26 sles11d -- MARK --.
06:17:26 <46>Jun 10 06:17:26 sles11d -- MARK --.
06:17:26 <46>Jun 10 06:17:26 sles11d syslog-ngY53012": Log statistics; dropped=
06:37:26 <46>Jun 10 06:37:26 sles11d -- MARK --.
06:57:26 <46>Jun 10 06:57:26 sles11d -- MARK --.
07:17:26 <46>Jun 10 07:17:26 sles11d -- MARK --.
07:17:26 <46>Jun 10 07:17:26 sles11d syslog-ngY53012": Log statistics; dropped=
07:37:26 <46>Jun 10 07:37:26 sles11d -- MARK --.
07:57:27 <46>Jun 10 07:57:27 sles11d -- MARK --.
08:17:26 <46>Jun 10 08:17:26 sles11d syslog-ngY53012": Log statistics; dropped=
08:37:27 <46>Jun 10 08:37:27 sles11d -- MARK --.
08:57:27 <46>Jun 10 08:57:27 sles11d -- MARK --.
09:17:27 <46>Jun 10 09:17:27 sles11d -- MARK --.
09:17:27 <46>Jun 10 09:17:27 sles11d syslog-ngY53012": Log statistics; dropped=
09:37:27 <46>Jun 10 09:37:27 sles11d -- MARK --.
09:57:27 <46>Jun 10 09:57:27 sles11d -- MARK --.
10:17:27 <46>Jun 10 10:17:27 sles11d -- MARK --.
10:17:27 <46>Jun 10 10:17:27 sles11d syslog-ngY53012": Log statistics; dropped=
10:37:27 <46>Jun 10 10:37:27 sles11d -- MARK --.
10:57:27 <46>Jun 10 10:57:27 sles11d -- MARK --.
11:17:27 <46>Jun 10 11:17:27 sles11d -- MARK --.
11:17:27 <46>Jun 10 11:17:27 sles11d syslog-ngY53012": Log statistics; dropped=
11:37:27 <46>Jun 10 11:37:27 sles11d -- MARK --.
PF01= SCROLL PF02=          PF03= END      PF04=          PF05= HOLD    PF06= FORMAT
PF07= UP      PF08= DOWN    PF09=          PF10= LEFT    PF11= RIGHT  PF12= RECALL
LXSYSLOG (Scroll)
MA  A 31/001
Connected to remote server/host 9.60.86.71 using port 23

```

Scenario 17: How Do You Do That?

■ For console data

- Make OPMGRM1 the secondary user of OPERATOR and SLES11D
 - Via CONSOLE statement in CP directory entry (recommended)
 - Via SET SECUSER command

■ For Linux syslog data

- Set up TCP/IP listener for syslog data

```
*  
DEFTCPA NAME(LNXSYSLG),+  
TCPUSER(TCPIP),+  
TCPAPPL(GOMRSYL),+  
TCPADDR(000.000.000.000),+  
TCPPORT(00514),+  
PARM(LXSYSLOG03330417UTF8)
```

- Update TCP/IP configuration to allow Operations Manager to listen for UDP traffic on the specified port(s)
 - Port 514 used here
- Update the Linux guest to send its syslog data to the IP address and port of your z/VM system
- Refer to white paper on Operations Manager web site for details

धन्यवाद

Hindi

多謝

Traditional Chinese

감사합니다

Korean

Спасибо

Russian

Gracias

Spanish

شكراً

Arabic



Thank You

English

Obrigado

Brazilian Portuguese

Grazie

Italian

多谢

Simplified Chinese

Danke

German

Merci

French

நன்றி

Tamil

ありがとうございました

Japanese

ขอบคุณ

Thai