

 #SHAREorg

# CICS Introduction to Web Services for the System Programmer

**Ezriel Gross**

Circle Software Incorporated

February 6, 2013 (Wed)

11:00am – 12:00pm

**Session 12450**



# Agenda

- Background: evolution of traditional CICS application design
  - Pseudoconversational transactions
  - Program communication (COMMAREAs, channels/containers)
- Introduction to XML
- Introduction to SOAP and web services
- Support for SOAP and web services in CICS
  - CICS web services tooling
- Implementation and configuration of web services in CICS
- CICS runtime support
- Summary

# Conversational transactions

- *Never* design these!
- When “conversing”, the transaction retains all the associated storage
- To prevent this, use pseudo-conversational techniques...

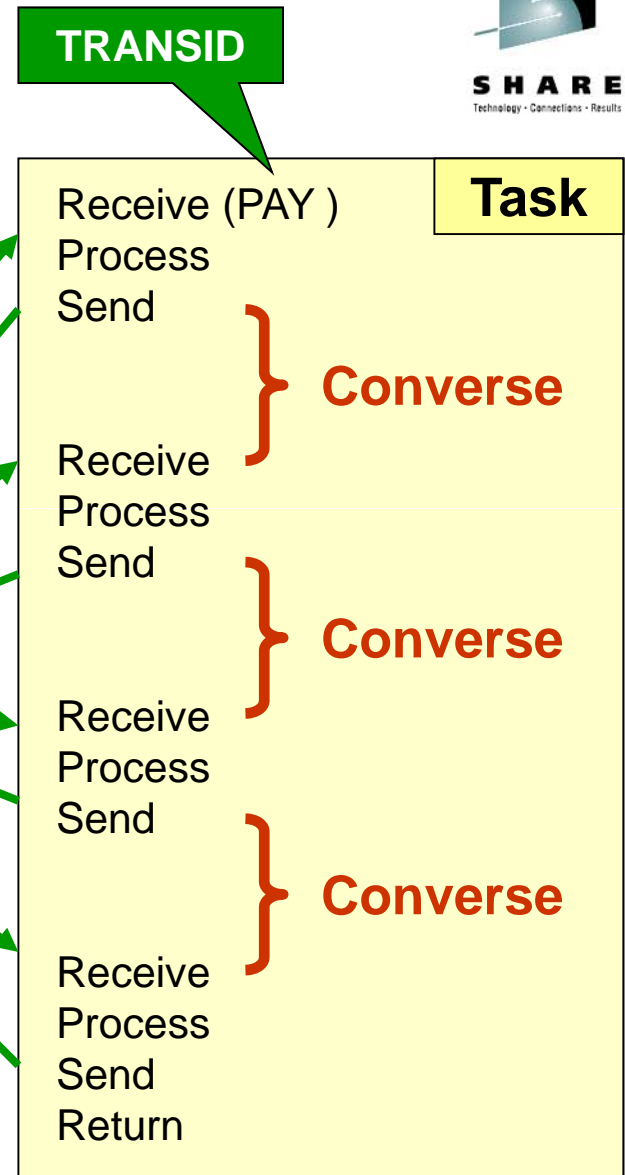

# Pseudoconversational transactions

- Use the TRANSID= option of the Return command to nominate the next transaction to be invoked
- Place data to be passed from one transaction to another in COMMAREA



Receive (PAY ) Process Send	<b>Task</b>
Return TRANSID=PAY COMMAREA(name)	

Receive Process Send	<b>Task</b>
Return TRANSID=PAY COMMAREA(name)	

Receive Process Send	<b>Task</b>
Return TRANSID=PAY COMMAREA(name)	

Receive Process Send	<b>Task</b>
Return (no COMMAREA or TRANSID)	

# Pseudoconversational programming

- Pros
  - Less resource-intensive
  - User think time costs eliminated
  - Can run more simultaneous transactions
- Cons
  - Programming more difficult
  - Application design requires re-starting program
  - More difficult to debug programs
  - Programs require area to store data between tasks

# Communication Area (COMMAREA)

- Terminal-based scratchpad
- Dynamic in size (0 to 32,500 bytes)
- Private and chained to the terminal



```

Identification division
Program-Id. 'PAYROLL'.
Working-storage Section.
    01 task-data.
        02 data1    pic s9(8) comp.
        02 data2    pic x(4).
Linkage Section.
    01 dfhcommarea pic x(8).

Procedure Division.
    if eibcalen = 0
        add 1 to data1
        exec cics send ... first screen
        exec cics return transid ('PAY ')
        commarea (task-data) end-exec.
    end if

    move dfhcommarea to task-data.

    if data1 = 1
        add 1 to data1
        exec cics send ... second screen
        exec cics return transid ('PAY ')
        commarea (task-data) end-exec.

    if data1 = 2
        exec cics send ... third screen
        exec cics return end-exec.

```

## COMMAREA basics

- Used to hold data between pseudo-conversations
- 32K maximum in size
- It can be passed from program to program
- It can be empty, partially full, or full
- Is automatically cleaned up when not used
- Is attached to the terminal

# COMMAREA for passing data to next task

## PAY

Working storage

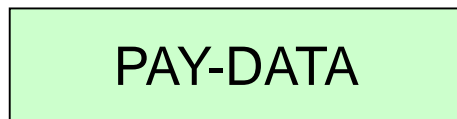

Copy

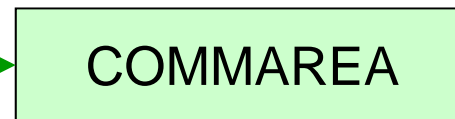

## PAYROLL

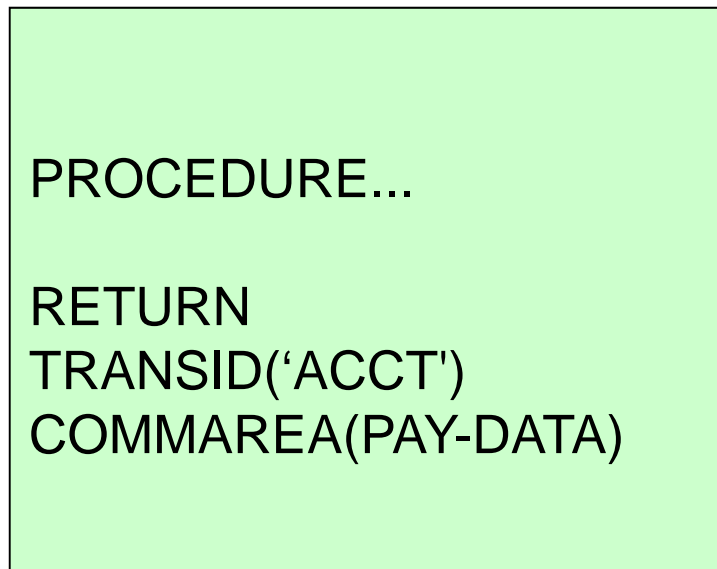

## ACCT

### ACCOUNT

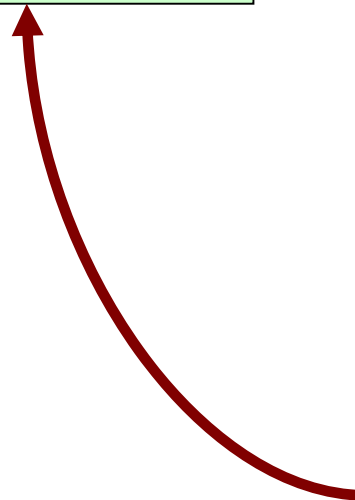
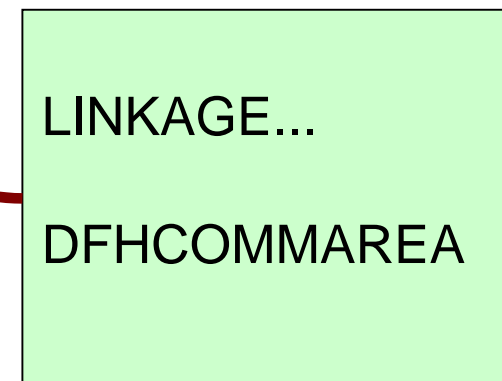



# Continually using COMMAREA

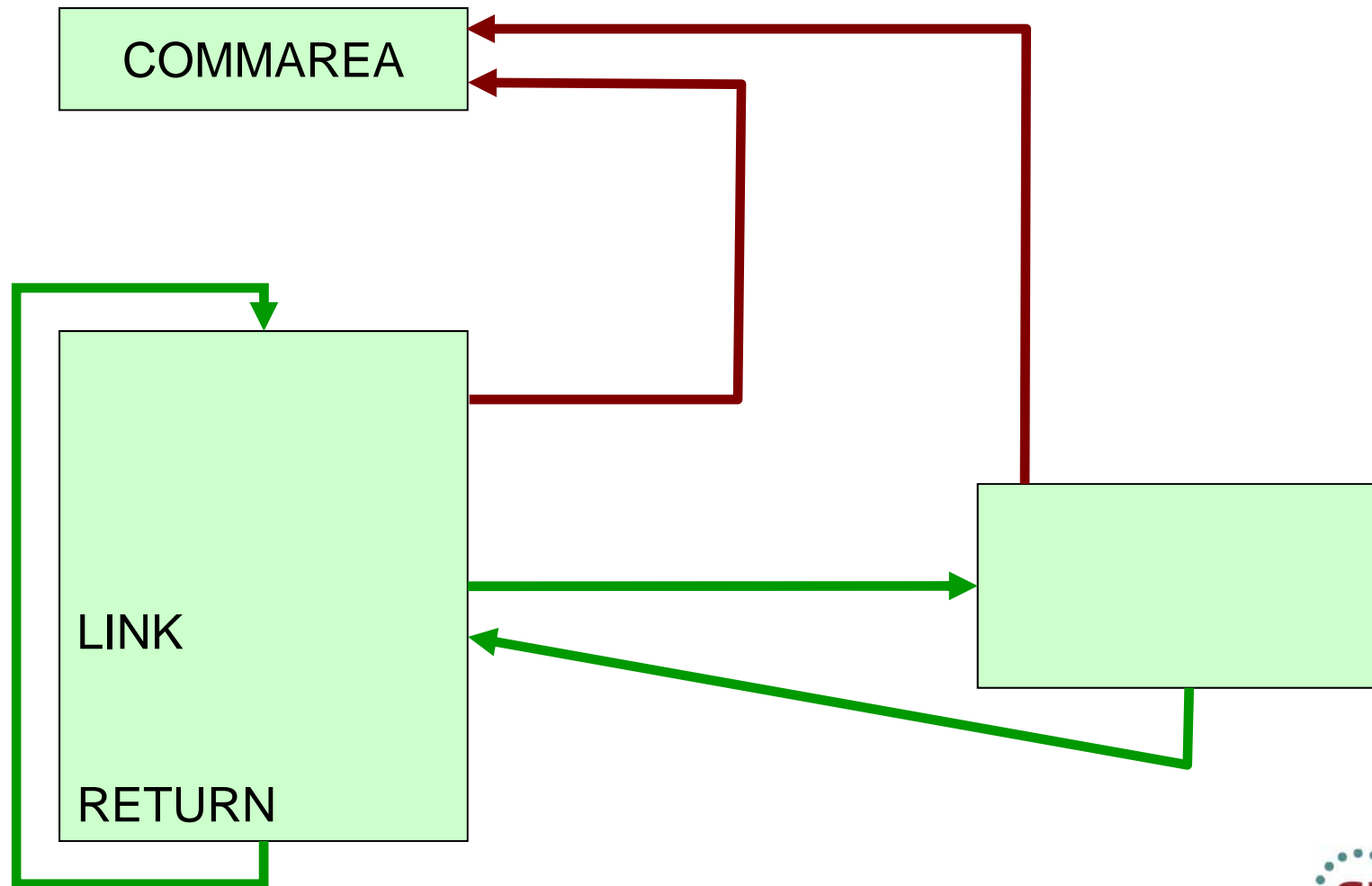

# CICS essential design concepts

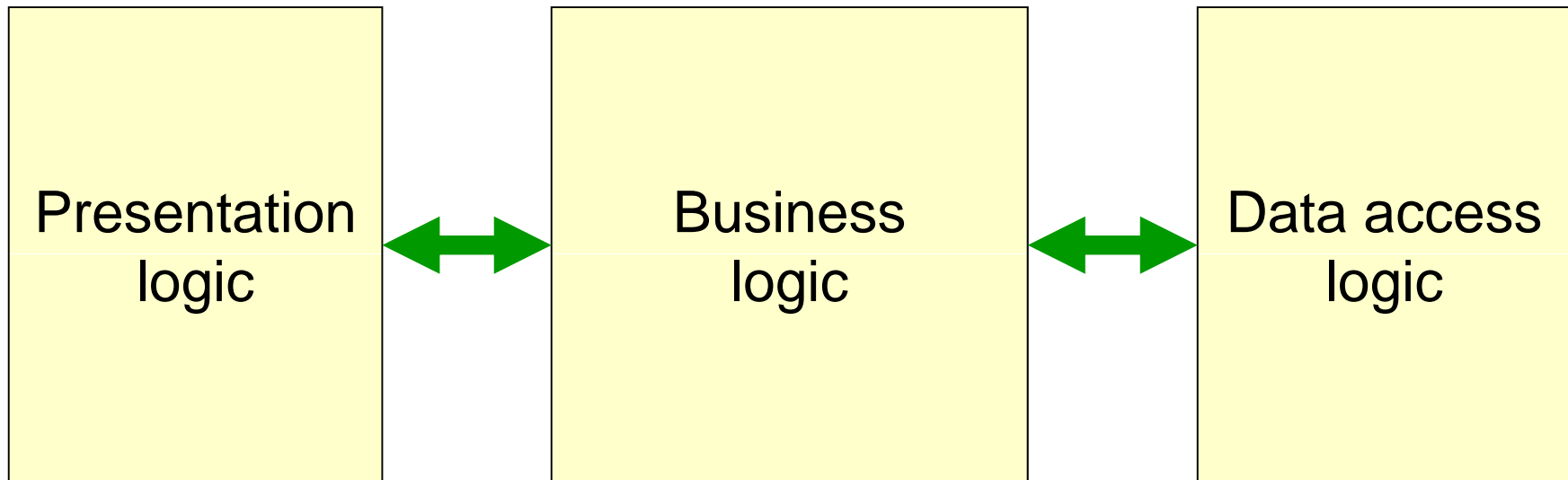

- Pseudo-conversational programming
- Communication area: COMMAREA
- Program-to-program communication

# Program-to-program communication

- Modular design and code reusability incorporated
- CALL → non-CICS, can be used with CICS
- LINK → CICS to CICS
- XCTL → CICS to CICS
- ECI Call → CICS Client to CICS
- EXCI Call → z/OS to CICS
- COMMAREA supported in all call types

# Contrasting various call types

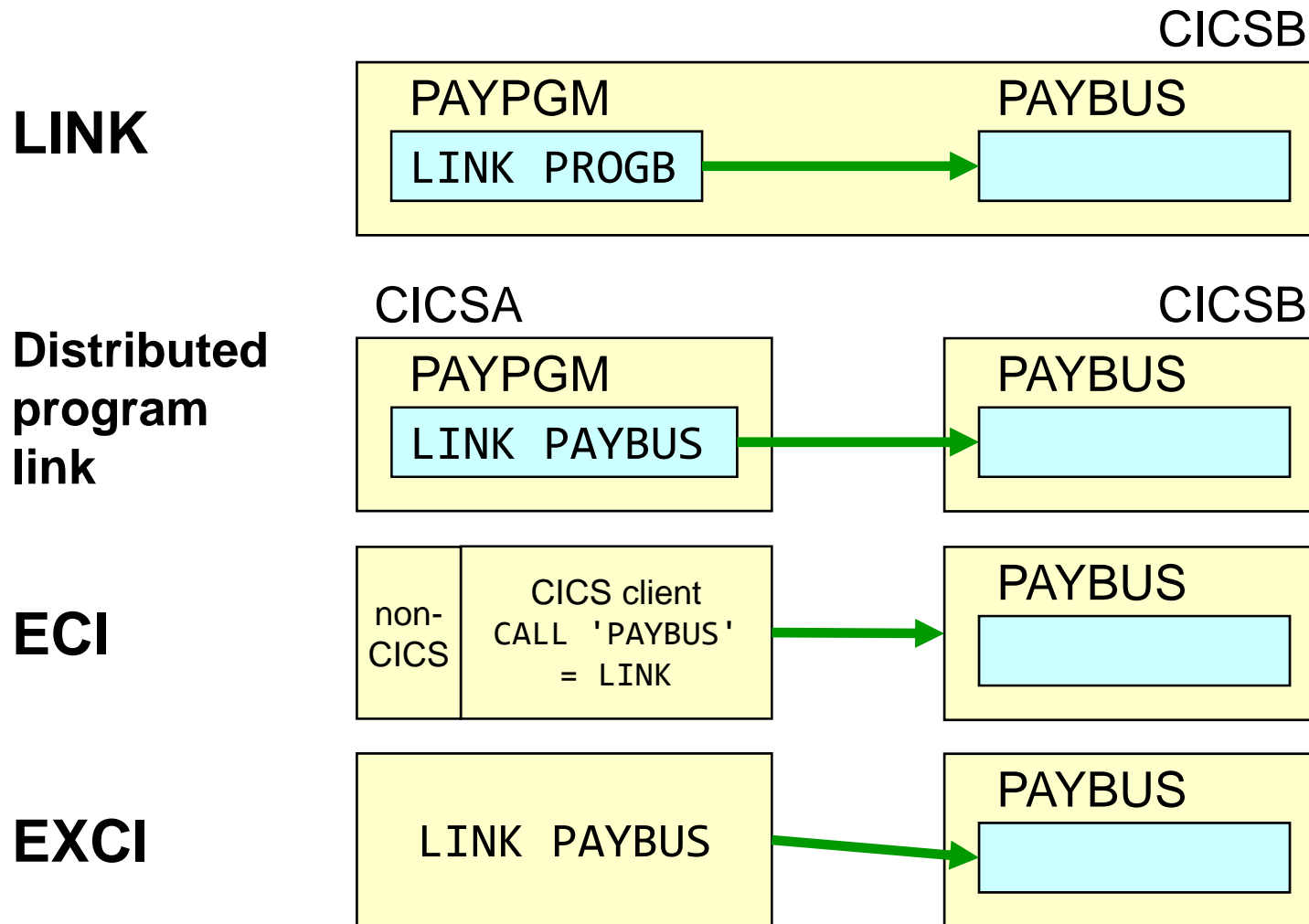

## z/OS batch or TSO

Complete your sessions evaluation online at [SHARE.org/SanFranciscoEval](http://SHARE.org/SanFranciscoEval)

## COMMAREA challenges

- Limited to 32K in length
- Only one can be passed to a program
- Contains different data types
- Contains unrelated data structures
- Entire COMMAREA available to all programs in UOW

# Channels and containers

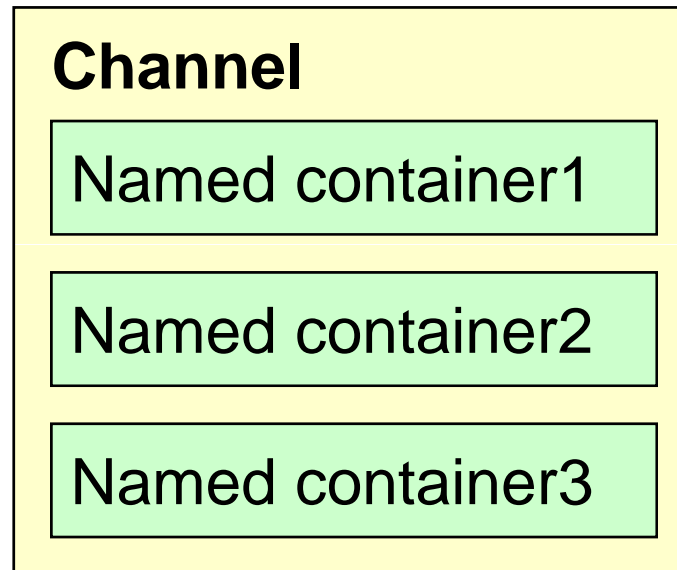

- No size limitation of data in containers
- Number of containers in a channel unlimited
- Can have separate containers for input and output

## A COMMAREA alternative

```
EXEC CICS xxxx  
  COMMAREA(data-area)
```

```
EXEC CICS xxxx  
  CHANNEL(channel-name)
```

## LINK using a channel

PAYPGM

```
LINK PAYBUS  
  CHANNEL(PAY-DATA)
```

PAYBUS

```
·  
·  
·  
RETURN  
CHANNEL(PAY-DATA)
```

# Sample COMMAREA

```
*****  
* PAYROLL COMMUNICATION FIELDS *  
*****  
01 ws-payroll-data.  
  02 ws-request          pic x(4).  
  02 ws-key.  
    05 ws-department    pic x.  
    05 ws-employee-no  pic x(5).  
  02 ws-name            pic x(20).  
  02 ws-addr1           pic x(20).  
  02 ws-addr2           pic x(20).  
  02 ws-addr3           pic x(20).  
  02 ws-phone-no       pic x(8).  
  02 ws-timestamp      pic x(8).  
  02 ws-salary         pic x(8).  
  02 ws-start-date     pic x(8).  
  02 ws-remarks        pic x(32).  
  02 ws-msg            pic x(60).  
  .  
  .
```

- Full COMMAREA length is 1036 bytes



## Problems with raw data communication

- Data must be accessed using its relative position
- Modifications to fields require application changes
- Addition of new fields affect all existing users
- Data requires a separate document to describe fields
- Data is not portable therefore platform dependant

# Introduction to XML

- Extensible Markup Language (XML), is owned by the World Wide Web Consortium (W3C).
- XML is an open standard protocol that provides a mechanism to create and define a meta-language that can be used to structure information.
- XML is extensible in that there are no pre-defined tags, as in HTML. Each set of users defines tags that have meaning to them and their peers, such as within a business, across an industry, or across multiple industries.
- XML is used to create new Internet languages.

# Introduction to XML

- XML tagging means that the context of the data is retained along with the information. Therefore, a name is not just a string of characters but can be described as a customer name, last name, first name, and so forth.
- XML is portable and self-defining, down to the code page used, so you can ship XML to any platform and to any application worldwide. If that application is able to process XML, you know that the information can be retrieved and processed.
- As the creator of XML, you do not need to understand where the data will eventually be used.
- As the receiver of XML, you do not need to know where it originated

# XML front-end application

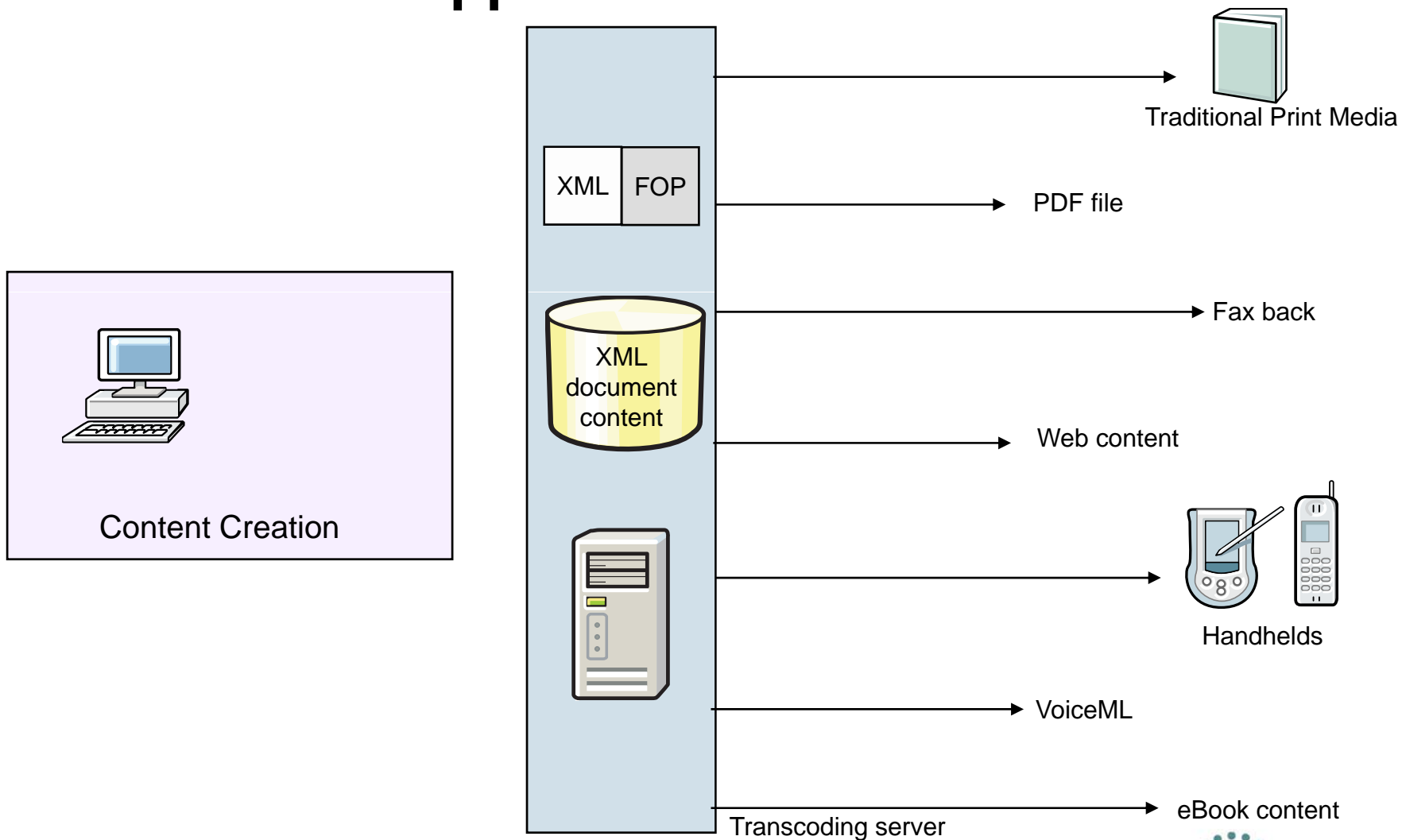

# XML syntax

- XML documents use a self-describing, simple syntax.

```
<?xml version="1.0" encoding="ISO-8859-1"?>
<ws-payroll-data>
  <ws-request>DISP</ws-request>
  <ws-department>1</ws-department>
  <ws-employee>00001</ws-employee>
</ws-payroll-data>
```

- The first line is the XML declaration. It defines the XML version (1.0) and the encoding used (ISO-8859-1) represents the Latin-1/West European character set.
- The `<ws-payroll-data>` tag describes the root element of the document.
- The `<ws-request>`, `<ws-department>` and `<ws-employee>` tags describe three child elements of the root.
- The `</ws-payroll-data>` tag defines the end of the root element.

# XML glossary

- **Extensible Stylesheet Language Transformation (XSLT)** is the recommended style sheet language of XML.
- **XML namespaces:** In XML, element names are defined by a developer.
- **XML schema** is an XML document that describes the structure and constrains the contents of other XML documents.
- **XML parser** is a program that is invoked by an application to process an XML document, ensure that it meets all the rules of XML as well as the syntax of the DTD or schema, making the data available to the calling application.

# XML technologies

- **Parsers:**
  - Document Object Model (DOM) builds a tree structure in memory as a result of parsing an input document.
  - Simple API for XML (SAX) triggers an event when a tag is encountered, causing execution of an event handler.
  - Most parsers validate an input document against a document type definition (DTD).
- **Generators:**
  - DOM based generators walk the tree structure and produce a valid XML document as a result.
  - Template based generators insert data values into a pre-built XML document template.
- **Transformers:**
  - Transform a document with one DTD into a document with a different DTD, using corresponding tags.

## Parse XML input: alternatives

- COBOL XML PARSE command
- COBOL program logic
- COBOL UNSTRING command
- EXEC CICS TRANSFORM XMLTODATA (CICS V4)
  - Requires running DFHSC2LS in advance



# COBOL XML PARSE statement: Format

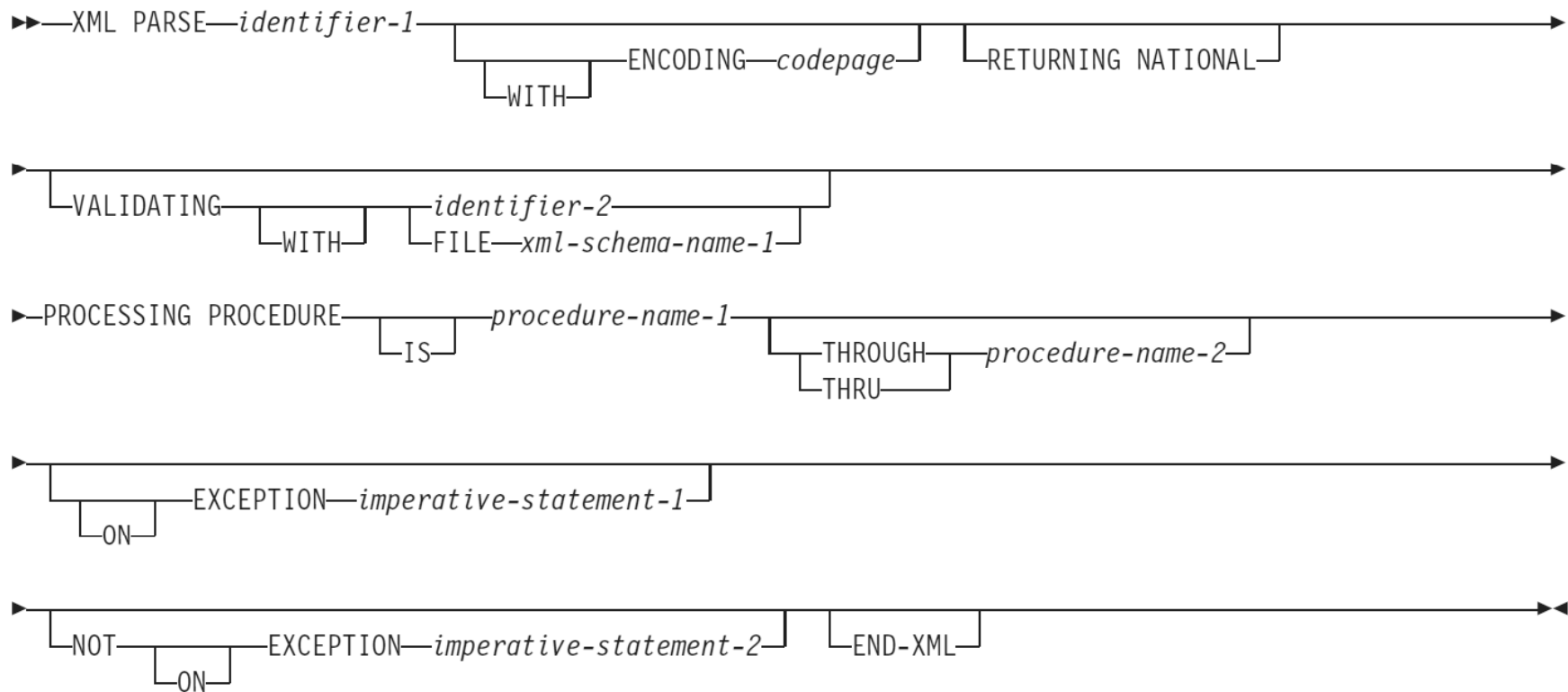

# COBOL XML PARSE statement: control flow

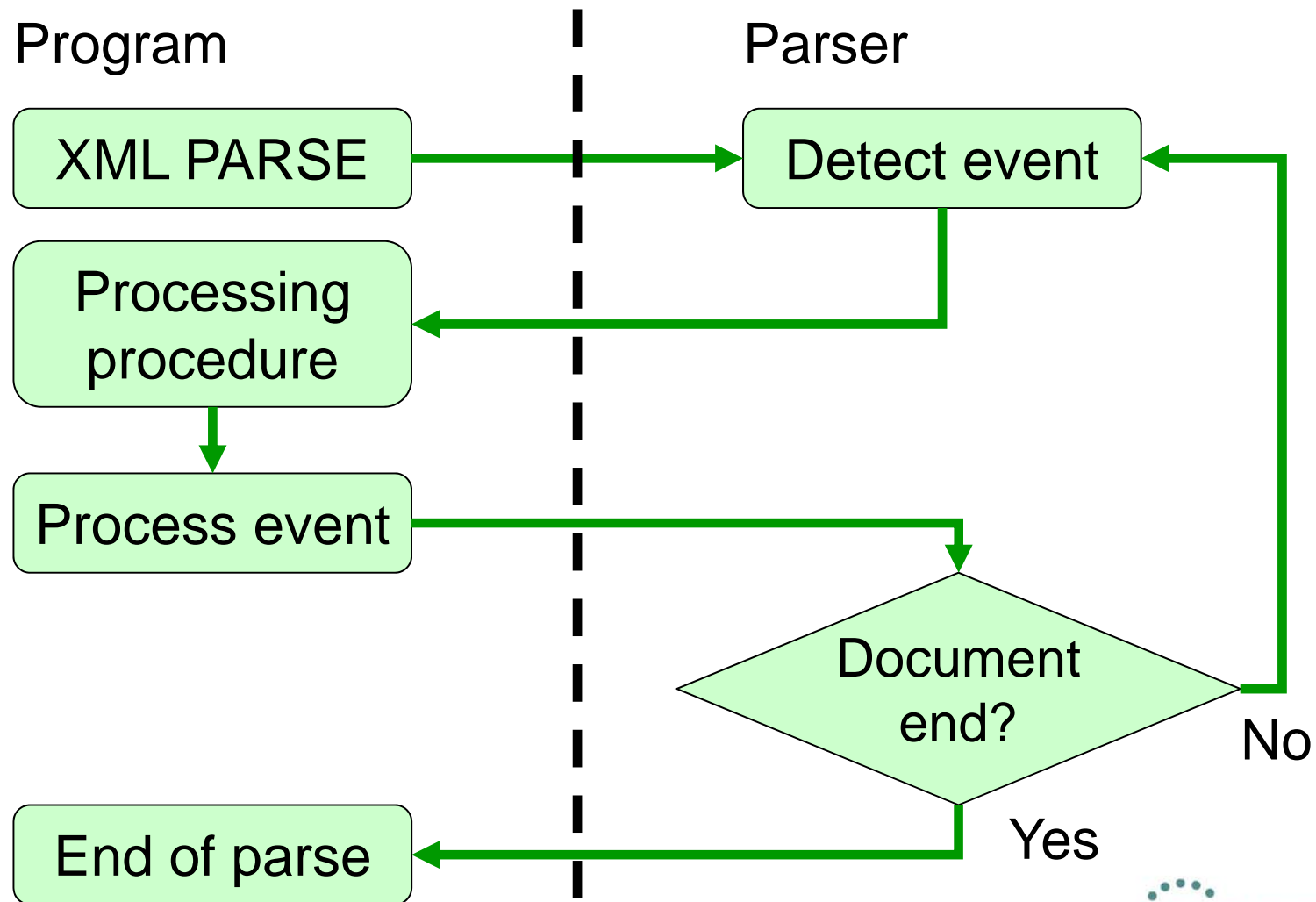

# COBOL XML PARSE statement: Special registers

- To receive and pass information:
  - **XML-CODE** to determine the status of XML parsing
  - **XML-EVENT** to receive the name of each XML event
  - **XML-TEXT** to receive XML document fragments from an alphanumeric document
  - **XML-NTEXT** to receive XML document fragments from a national document

# COBOL XML PARSE statement: XML-EVENT event parameters

ATTRIBUTE-CHARACTER  
ATTRIBUTE-CHARACTERS  
ATTRIBUTE-NAME  
ATTRIBUTE-NATIONAL-CHARACTER  
COMMENT  
CONTENT-CHARACTER  
CONTENT-CHARACTERS  
CONTENT-NATIONAL-CHARACTER  
DOCUMENT-TYPE-DECLARATION  
ENCODING-DECLARATION  
END-OF-CDATA-SECTION  
END-OF-DOCUMENT  
END-OF-ELEMENT

EXCEPTION  
PROCESSING-INSTRUCTION-DATA  
PROCESSING-INSTRUCTION-TARGET  
STANDALONE-DECLARATION  
START-OF-CDATA-SECTION  
START-OF-DOCUMENT  
START-OF-ELEMENT  
UNKNOWN-REFERENCE-IN-ATTRIBUTE  
UNKNOWN-REFERENCE-IN-CONTENT  
VERSION-INFORMATION

# COBOL XML PARSE statement: XML-EVENT event parameters

```
<!--This document is just an example-->
```

```
WHEN 'COMMENT'
```

```
*****
```

```
* 'COMMENT' = "This document is just an example"
```

```
*****
```

```
.....
```

```
<bread type="baker's best " />
```

```
WHEN 'START-OF-ELEMENT'
```

```
*****
```

```
* 'START-OF-ELEMENT' = "bread"
```

```
*****
```

```
.....
```

```
WHEN 'ATTRIBUTE-NAME'
```

```
*****
```

```
* 'ATTRIBUTE-NAME' = "type"
```

```
*****
```

```
.....
```

```
WHEN 'ATTRIBUTE-CHARACTERS'
```

```
*****
```

```
* 'ATTRIBUTE-CHARACTERS' = "baker"
```

```
*****
```

```
.....
```

```
WHEN 'ATTRIBUTE-CHARACTER'
```

```
*****
```

```
* 'ATTRIBUTE-CHARACTER' = "'" (&apos;)
```

```
*****
```

```
.....
```

```
WHEN 'ATTRIBUTE-CHARACTERS'
```

```
*****
```

```
* 'ATTRIBUTE-CHARACTERS' = "s best"
```

```
*****
```

```
.....
```

```
WHEN 'END-OF-ELEMENT'
```

```
*****
```

```
* 'END-OF-ELEMENT' = "bread"
```

```
*****
```

```
.....
```

# COBOL XML PARSE statement: XML-EVENT event parameters

```
UNSTRING LS-BUFFER
  DELIMITED BY '<WS-Request>' OR
  '<ws-request>' OR
  '<WS-REQUEST>' OR
  '</WS-Request>' OR
  '</ws-request>' OR
  '</WS-REQUEST>'
  INTO WS-WS WS-REQUEST
END-UNSTRING.
```

## Generate XML output: alternatives

- COBOL XML GENERATE statement
- COBOL MOVE CORRESPONDING statement
- Roll-your-own COBOL code
- EXEC CICS TRANSFORM DATATOXML (CICS V4)
  - Requires running DFHLS2SC in advance

# COBOL XML GENERATE statement: Format

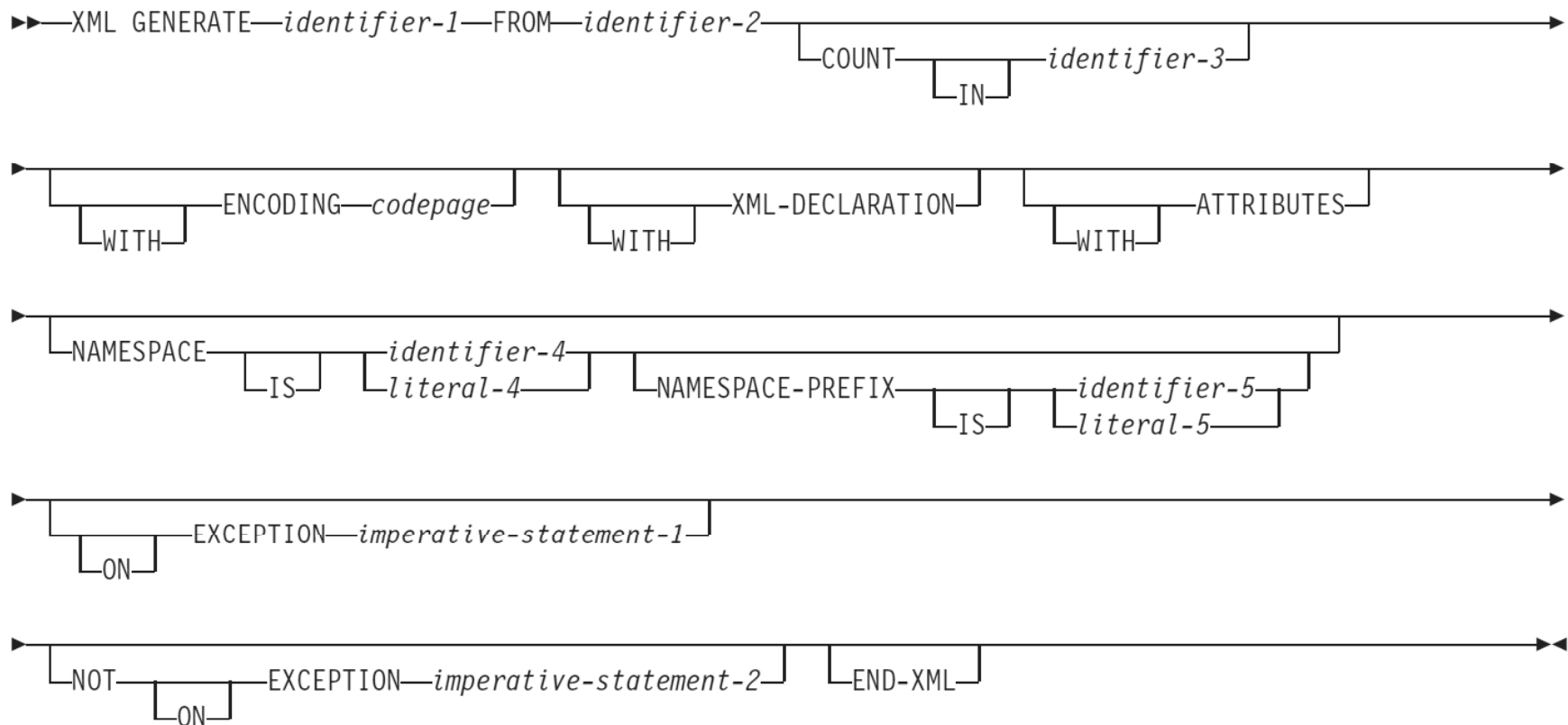



# XML GENERATE statement: example (1 of 3)

```
01 FILLER PIC X(16) VALUE 'RESPONSE HEADERS'.
01 RESPONSE-HEADERS.
    05 CONTENT-TYPE-VX          PIC X(8) VALUE 'text/xml'.
    05 CONTENT-TYPE-VX-L       PIC S9(8) COMP VALUE +8.
01 FILLER PIC X(8) VALUE 'customer'.
01 ws-payroll-data.
    02 ws-request              pic x(4).
    02 ws-key.
        05 ws-department      pic x.
        05 ws-employee-no     pic x(5).
    02 ws-name                 pic x(20).
    02 ws-addr1                pic x(20).
    02 ws-addr2                pic x(20).
    02 ws-addr3                pic x(20).
    02 ws-phone-no             pic x(8).
    02 ws-timestamp            pic x(8).
    02 ws-salary                pic x(8).
    02 ws-start-date           pic x(8).
    02 ws-remarks              pic x(32).
    02 ws-msg                  pic x(60).
01 FILLER PIC X(8) VALUE 'XML-AREA'.
01 XML-AREA.
    05 FILLER PIC X(43) VALUE '<?xml version="1.0" encoding="ISO-8859-1"?>'.
    05 XMLOUT PIC X(512) VALUE SPACES.
```

# XML GENERATE statement: example (2 of 3)

```
WHEN '2'
  EXEC CICS
    LINK
      PROGRAM('WBCUSB99')
      COMMAREA(customer)
  END-EXEC

  XML GENERATE
    XMLOUT FROM
      ws-payroll-data

  PERFORM 0700-SEND-CUST
  PERFORM 0900-RETURN

0700-SEND-CUST.
  EXEC CICS
    DOCUMENT CREATE
    DOCTOKEN(DOCUMENT-TOKEN)
    NOHANDLE
  END-EXEC.
  EXEC CICS
    DOCUMENT INSERT
    DOCTOKEN(DOCUMENT-TOKEN)
    TEXT(XML-AREA)
    LENGTH(LENGTH OF XML-AREA)
    NOHANDLE
  END-EXEC
  PERFORM 0800-WRITE-CONTENT-TYPE-XML

  PERFORM 0800-WRITE-PRAGMA-HEADER.
  EXEC CICS
    WEB SEND
    DOCTOKEN(DOCUMENT-TOKEN)
    CLNTCODEPAGE('819')
  END-EXEC.
```

## XML GENERATE statement: example (3 of 3)

```
<?xml version="1.0" encoding="ISO-8859-1" ?>
<ws-payroll-data>
<ws-request>DISP</ws-request>
<ws-key>
<ws-department>1</ws-department>
<ws-employee-no>00001</ws-employee-no>
</ws-key>
<ws-name>EZRIEL</ws-name>
<ws-addr1>123 WILLOWBROOK BLVD</ws-addr1>
<ws-addr2>WAYNE, NJ</ws-addr2>
<ws-addr3>07470</ws-addr3>
.
.
.
</ws-payroll-data>
```

# MOVE CORRESPONDING statement: message text

```

01  XML-MESSAGE-TEXT.
    05  FILLER                PIC X(12) VALUE '<LOANSTATUS>'.
    05  FILLER                PIC X(06) VALUE '<Loan>'.
    05  FILLER                PIC X(09) VALUE '<LoanNum>'.
    05  LS-LOAN-NUM          PIC X(10) VALUE SPACE.
    05  FILLER                PIC X(10) VALUE '</LoanNum>'.
    05  FILLER                PIC X(09) VALUE '<SalesAU>'.
    05  LS-SALES-AU         PIC X(06) VALUE SPACE.
    05  FILLER                PIC X(10) VALUE '</SalesAU>'.
    05  FILLER                PIC X(15) VALUE '<FulfillmentAU>'.
    05  LS-FULL-AU          PIC X(06) VALUE SPACE.
    05  FILLER                PIC X(16) VALUE '</FulfillmentAU>'.
    05  FILLER                PIC X(18) VALUE '<BorrowerLastName>'.
    05  LS-BORR-LNAME       PIC X(30) VALUE SPACE.
    05  FILLER                PIC X(19) VALUE '</BorrowerLastName>'.
    . . . . .
    05  FILLER                PIC X(09) VALUE '<HMCLast>'.
    05  LS-HMC-LNAME        PIC X(30) VALUE SPACE.
    05  FILLER                PIC X(10) VALUE '</HMCLast>'.
    05  FILLER                PIC X(16) VALUE '<HMCOfficePhone>'.
    05  LS-HMC-OFF-PHONE    PIC X(10) VALUE SPACE.
    05  FILLER                PIC X(17) VALUE '</HMCOfficePhone>'.
    05  FILLER                PIC X(11) VALUE '</Employee>'.
    05  FILLER                PIC X(13) VALUE '</LOANSTATUS>'.

```

# MOVE CORRESPONDING statement: message text

```

01 WS-COMMAREA.
   05 LINK-LOAN-NUM          PIC x(10).
   05 LINK-SYS-ORIG         PIC x(03).
   05 HTML-LOAN-STATUS.
       10 LS-LOAN-NUM        PIC X(10) VALUE SPACE.
       10 LS-SALES-AU        PIC X(06) VALUE SPACE.
       10 LS-FULL-AU         PIC X(06) VALUE SPACE.
       10 LS-BORR-LNAME      PIC X(30) VALUE SPACE.
       . . . . .
       10 LS-HMC-LNAME       PIC X(30) VALUE SPACE.
       10 LS-HMC-OFF-PHONE   PIC X(10) VALUE SPACE.
       10 LS-ERROR-MSG      PIC X(50) VALUE SPACE.

```

```

*****
* BUILD THE XML RESPONSE.
*****
0300-BUILD-MESSAGE.

MOVE CORRESPONDING HTML-LOAN-STATUS
TO XML-MESSAGE-TEXT.

```

# Character entities

- Five special pieces of code for characters that are recognized as part of the XML language.
- Must be used if these characters are used as part of an elements content.
- Character entities use a special syntax to represent the character in a way that avoids the XML parser interpreting the character as code.
- Standard character entities are:
  - `&lt;`; represents the '`<`' character
  - `&gt;`; represents the '`>`' character
  - `&amp;`; represents the '`&`' character
  - `&apos;`; represents the '`'`' character
  - `&quot;`; represents the '`"`' character
- To add characters that are not generally available XML supports character references using its Unicode character code: `&#nnn;` where *nnn* is the code

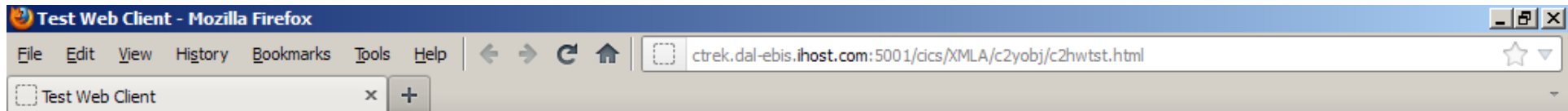

# Generic XML Tester

Written by Circle Software Inc

XML Function:

Loop Count:

XML Envelope:

```
<ws_payroll_data>
  <ws_request>DISP</ws_request>
  <ws_key>
    <ws_department>1</ws_department>
    <ws_employee_no>00001</ws_employee_no>
  </ws_key>
</ws_payroll_data>
```

Enter

XML Response:

```
<ws_payroll_data><ws_request>DISP</ws_request><ws_key><ws_department>1</ws_department>
<ws_employee_no>00001</ws_employee_no></ws_key><ws_name>CIRCLE EDUCATION LTD</ws_name>
<ws_addr1>QUEENSBURY HSE</ws_addr1><ws_addr2>BRIGHTON</ws_addr2><ws_addr3>SUSSEX</ws_addr3>
<ws_phone_no>75529900</ws_phone_no><ws_timestamp></ws_timestamp><ws_salary>1234.56</ws_salary>
<ws_start_date>28101984</ws_start_date><ws_remarks>CIRCLE IS MAGIC</ws_remarks><ws_upd_inds>
</ws_upd_inds><ws_item_no> y</ws_item_no><ws_line_out></ws_line_out><ws_line_out></ws_line_out>
<ws_line_out></ws_line_out><ws_line_out></ws_line_out><ws_line_out></ws_line_out><ws_line_out>
</ws_line_out><ws_line_out></ws_line_out><ws_line_out></ws_line_out><ws_line_out></ws_line_out>
<ws_line_out></ws_line_out></ws_payroll_data>
```

# CICS web services overview

- Web services terms and concepts available in CICS TS
- Web services architecture:
  - Service provider
  - Service requestor
  - Service registry
- WSDL
- SOAP messages
- Message handlers and pipelines
- PIPELINE and WEBSERVICE resource definitions



# Introduction to web services

- A web service is a collection of operations that are network accessible through standardized XML messaging.
- The web services architecture is based upon interactions between three components:
  - Service provider is the platform that hosts access to the service.
  - Service requester is the application that is looking for and invoking or initiating an interaction with a service.
  - Service registry is a place where service providers publish their service descriptions, and where service requesters find them.
- Universal Description, Discovery and Integration (UDDI) is a specification for distributed web-based information registries of web services.

# Web services architecture

- Architecture

- Service provider
  - “Owns” the service
  - Creates the WSDL
  - Publishes the WSDL
  - Processes the requests
- Service requester
  - “Finds” the service
  - Binds to the service
    - *Invokes the service using the WSDL*
- Service registry
  - Hosts the service description
  - Optional for statically bound requesters

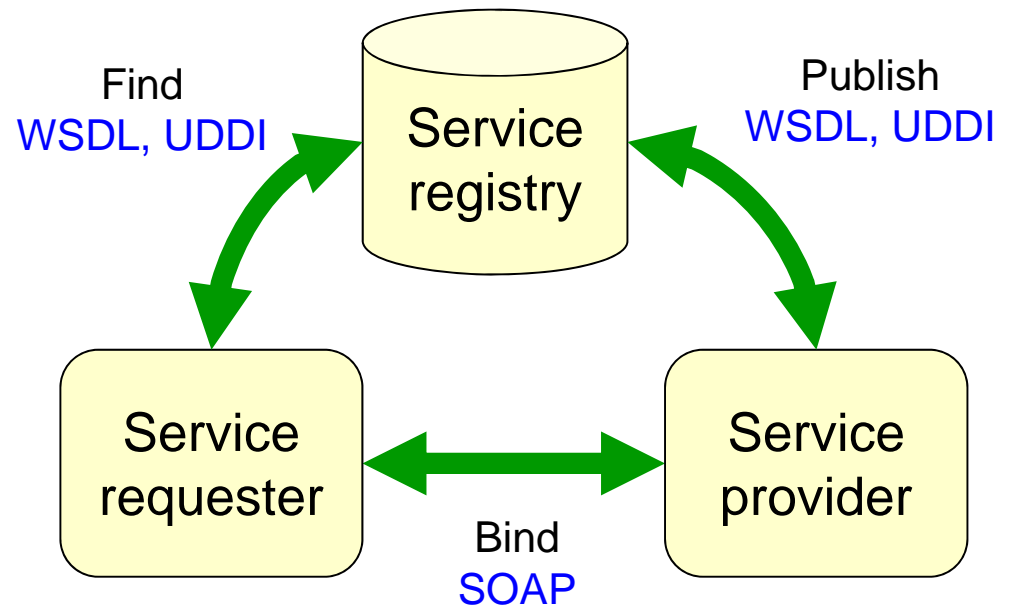

# Web Service Description Language (WSDL)

- Web Service Description Language (WSDL) is an XML application for describing web services.
- WSDL is comprised of:
  - **Types**: the data types in the form of XML schemas
  - **Message**: an abstract definition of the data in the form of a message
  - **PortType**: an abstract set of operations mapped to one or more end points
  - **Binding**: the concrete protocol and data formats for the operations
  - **Service**: a collection of related end points

# WSDL generation: Input

```
//SYSEGXLS JOB (39248C,A,T), 'LS2WS',
// MSGCLASS=A, NOTIFY=&SYSUID, REGION=0M
// SET QT= ''
//WHERE SMA JCLLIB ORDER=CIRCLE.CICSWS.PROCLIB
//JAVAPROG EXEC DFHLS2WS,
// JAVADIR='Java/J6.0.1_64', PATHPREF='/u', TMPDIR='/u/tmp',
// TMPFILE=&QT.&SYSUID.&QT, USSDIR='cicsts42'
//INPUT.SYSUT1 DD *
PDSLIB=CIRCLE.CICSWS.COPYLIB
REQMEM=PAYCOM
RESPMEM=PAYCOM
PGMINT=COMMAREA
MAPPING-LEVEL=3.0
LANG=COBOL
PGMNAME=PAYBUS
URI=/paybus
WSBIND=/u/usr/lpp/cicsts/cicsts42/samples/webser
aybus.wsbinding
WSDL=/u/usr/lpp/cicsts/cicsts42/samples/webser
LOGFILE=/u/sysegx0/paybus
/*
```

## COBOL data structure

```
01 ws-payroll-data.
   02 ws-request          pic x(4).
   02 ws-key.
       05 ws-department  pic x.
       05 ws-employee-no pic x(5).
   02 ws-name            pic x(20).
   02 ws-addr1          pic x(20).
   02 ws-addr2          pic x(20).
   02 ws-addr3          pic x(20).
   02 ws-phone-no       pic x(8).
   02 ws-timestamp       pic x(8).
   02 ws-salary          pic x(8).
   02 ws-start-date      pic x(8).
   02 ws-remarks         pic x(32).
   02 ws-msg             pic x(60).
```

## WSDL generation: Output (1 of 7)

```
<?xml version="1.0" ?>
<!-- This document was generated using 'DFHLS2WS' at mapping level '3.0'. -->
<definitions targetNamespace="http://www.PAYBUS.PAYCOM.com"
  xmlns="http://schemas.xmlsoap.org/wsdl/"
  xmlns:reqns="http://www.PAYBUS.PAYCOM.Request.com"
  xmlns:resns="http://www.PAYBUS.PAYCOM.Response.com"
  xmlns:soap="http://schemas.xmlsoap.org/wsdl/soap/"
  xmlns:tns="http://www.PAYBUS.PAYCOM.com">
  <types> ...
  <message name="PAYBUSOperationResponse"> ...
  <message name="PAYBUSOperationRequest"> ...
  <portType name="PAYBUSPort"> ...
  <binding name="PAYBUSHTTPSoapBinding" type="tns:PAYBUSPort"> ...
  <service name="PAYBUSService"> ...
</definitions>
```

## WSDL generation: Output (2 of 7)

- Types identifies the data types in the form of XML schemas

<types>

```
<xsd:schema attributeFormDefault="qualified"
  elementFormDefault="qualified"
  targetNamespace="http://www.PAYBUS.PAYCOM.Request.com"
  xmlns:tns="http://www.PAYBUS.PAYCOM.Request.com"
  xmlns:xsd="http://www.w3.org/2001/XMLSchema"> ...
```

```
<xsd:schema attributeFormDefault="qualified"
  elementFormDefault="qualified"
  targetNamespace="http://www.PAYBUS.PAYCOM.Response.com"
  xmlns:tns="http://www.PAYBUS.PAYCOM.Response.com"
  xmlns:xsd="http://www.w3.org/2001/XMLSchema"> ...
```

</types>

## WSDL generation: Output (3 of 7)

```
<xsd:schema attributeFormDefault="qualified" elementFormDefault="qualified"
  targetNamespace="http://www.PAYBUS.PAYCOM.Request.com"
  xmlns:tns="http://www.PAYBUS.PAYCOM.Request.com"
  xmlns:xsd="http://www.w3.org/2001/XMLSchema">
  <xsd:annotation>
    <xsd:documentation source="http://www.ibm.com/software/htp/cics/annotations">This
schema was generated by the CICS Web services assistant.</xsd:documentation>
  </xsd:annotation>
  <xsd:annotation>
    <xsd:appinfo source="http://www.ibm.com/software/htp/cics/annotations">
com.ibm.cics.wsdl.properties.mappingLevel=3.0</xsd:appinfo>
  </xsd:annotation>
  <xsd:complexType abstract="false" block="#all" final="#all" mixed="false"
  name="ProgramInterface"> ...
  <xsd:element name="PAYBUSOperation" nillable="false" type="tns:ProgramInterface"/>
</xsd:schema>
```

## WSDL generation: Output (4 of 7)

```
<xsd:complexType abstract="false" block="#all" final="#all" mixed="false"
name="ProgramInterface">
  <xsd:sequence>
    <xsd:element name="ws_payroll_data" nillable="false">
      <xsd:complexType mixed="false">
        <xsd:sequence>
          <xsd:element name="ws_request" nillable="false">
            <xsd:simpleType>
              <xsd:annotation>
                <xsd:appinfo source="http://www.ibm.com/software/htp/cics/annotations">
                  com.ibm.cics.wSDL.properties.charlength=fixed
                  com.ibm.cics.wSDL.properties.synchronized=false</xsd:appinfo>
              </xsd:annotation>
              <xsd:restriction base="xsd:string">
                <xsd:maxLength value="4"/>
                <xsd:whiteSpace value="collapse"/>
              </xsd:restriction>
            </xsd:simpleType>
          </xsd:element>
```



## WSDL generation: Output (5 of 7)

- Message describes an abstract definition of the data in the form of a message

```
<message name="PAYBUSOperationResponse">  
  <part element="resns:PAYBUSOperationResponse" name="ResponsePart"/>  
</message>  
<message name="PAYBUSOperationRequest">  
  <part element="reqns:PAYBUSOperation" name="RequestPart"/>  
</message>
```

- PortType describes an abstract set of operations mapped to one or more end points

```
<portType name="PAYBUSPort">  
  <operation name="PAYBUSOperation">  
    <input message="tns:PAYBUSOperationRequest" name="PAYBUSOperationRequest"/>  
    <output message="tns:PAYBUSOperationResponse" name="PAYBUSOperationResponse"/>  
  </operation>  
</portType>
```

## WSDL generation: Output (6 of 7)

- Binding is the concrete protocol and data formats for the operations

```
<binding name="PAYBUSHTTPSoapBinding" type="tns:PAYBUSPort">
  <!-- This soap:binding indicates the use of SOAP 1.1 -->
  <soap:binding style="document"
    transport="http://schemas.xmlsoap.org/soap/http"/>
  <operation name="PAYBUSOperation">
    <soap:operation soapAction="" style="document"/>
    <input name="PAYBUSOperationRequest">
      <soap:body parts="RequestPart" use="literal"/>
    </input>
    <output name="PAYBUSOperationResponse">
      <soap:body parts="ResponsePart" use="literal"/>
    </output>
  </operation>
</binding>
```

## WSDL generation: Output (7 of 7)

- Service is a collection of related end points

```
<service name="PAYBUSService">
  <port binding="tns:PAYBUSHTTPSoapBinding" name="PAYBUSPort">
    <!-- This soap:address indicates the location of the Web service over HTTP.
      Please replace "my-server" with the TCPIP host name of your CICS region.
      Please replace "my-port" with the port number of your CICS TCPIP SERVICE. -->
    <soap:address location="http://my-server:my-port/paybus"/>
    <!-- This soap:address indicates the location of the Web service over HTTPS. -->
    <!-- <soap:address location="https://my-server:my-port/paybus"/> -->
    <!-- This soap:address indicates the location of the Web service over WebSphere MQSeries.
      Please replace "my-queue" with the appropriate queue name. -->
    <!-- <soap:address location="jms:/queue?destination=my-
queue&connectionFactory=()&targetService=/paybus&initialContextFactory=com.ibm.mq.jms.Nojndi" /> -->
  </port>
</service>
```

# Introduction to SOAP

- Simple Object Access Protocol (SOAP) is an XML based protocol for the exchange of information in a distributed environment.
- A SOAP message is encoded as an XML document, consisting of an <Envelope> element, which contains:
  - The SOAP <Header> is an optional element within the SOAP message, and is used to pass information in SOAP messages that is not application payload. The SOAP header allows features to be added to a SOAP message. SOAP defines a few attributes that can be used to indicate who should deal with a feature and whether it is optional or mandatory.
  - The SOAP <body>, a mandatory element, contains information intended for the ultimate recipient of the message. In CICS terms, this will become the COMMAREA for the application program.
  - The SOAP <fault>, contained within the <body>, is used for reporting errors.

# SOAP example (1 of 2)

```
<?xml version="1.0" encoding="UTF-8"?>
<soap:Envelope
  xmlns:wsa="http://schemas.xmlsoap.org/ws/2004/03/addressing"
  xmlns:pay="http://www.PAYBUS.PAYCOM.Request.com"
  xmlns:wss="http://docs.oasis-open.org/wss/2004/01/oasis-200401-wss-wssecurity-secext-1.0.xsd"
  xmlns:wsu="http://docs.oasis-open.org/wss/2004/01/oasis-200401-wss-wssecurity-utility-1.0.xsd"
  xmlns:soap="http://schemas.xmlsoap.org/soap/envelope/">
  <soap:Header>
    <wsa:Action>PAYBUS</wsa:Action>
    <wsa:MessageID>uuid:31f43668-eddf-40fe-9453-7777bb95df14</wsa:MessageID>
    <wsa:ReplyTo>
      <wsa:Address>
        http://schemas.xmlsoap.org/ws/2004/03/addressing/role/anonymous
      </wsa:Address>
    </wsa:ReplyTo>
    <wsa:To>http://ctrek.dal-ebis.ihost.com:6000/paybus</wsa:To>
    <wsse:Security>
      <wsu:Timestamp wsu:Id="Timestamp-9f1d63d6-b276-44d1-8c9f-68e24828d30a">
        <wsu:Created>2012-02-29T16:41:50Z</wsu:Created>
        <wsu:Expires>2012-02-29T16:46:50Z</wsu:Expires>
      </wsu:Timestamp>
    </wsse:Security>
  </soap:Header>
  ...
```

## SOAP example (2 of 2)

```
<soap:Body soap:encodingStyle="http://schemas.xmlsoap.org/soap/encoding/">  
  <PAYBUSOperation xmlns="http://www.PAYBUS.PAYCOM.Request.com">  
    <ws_payroll_data>  
      <ws_request>DISP</ws_request>  
      <ws_key>  
        <ws_department>1</ws_department>  
        <ws_employee_no>00001</ws_employee_no>  
      </ws_key>  
    </ws_payroll_data>  
  </PAYBUSOperation>  
</soap:Body>  
</soap:Envelope>
```

# SOAP fault example

```
<soap:Fault>  
  <faultcode>soap:Server</faultcode>  
  <faultstring>Server was unable to process request. --&gt; Something bad  
happened</faultstring>  
  <detail />  
</soap:Fault>
```

# Approach to web services development (1 of 2)

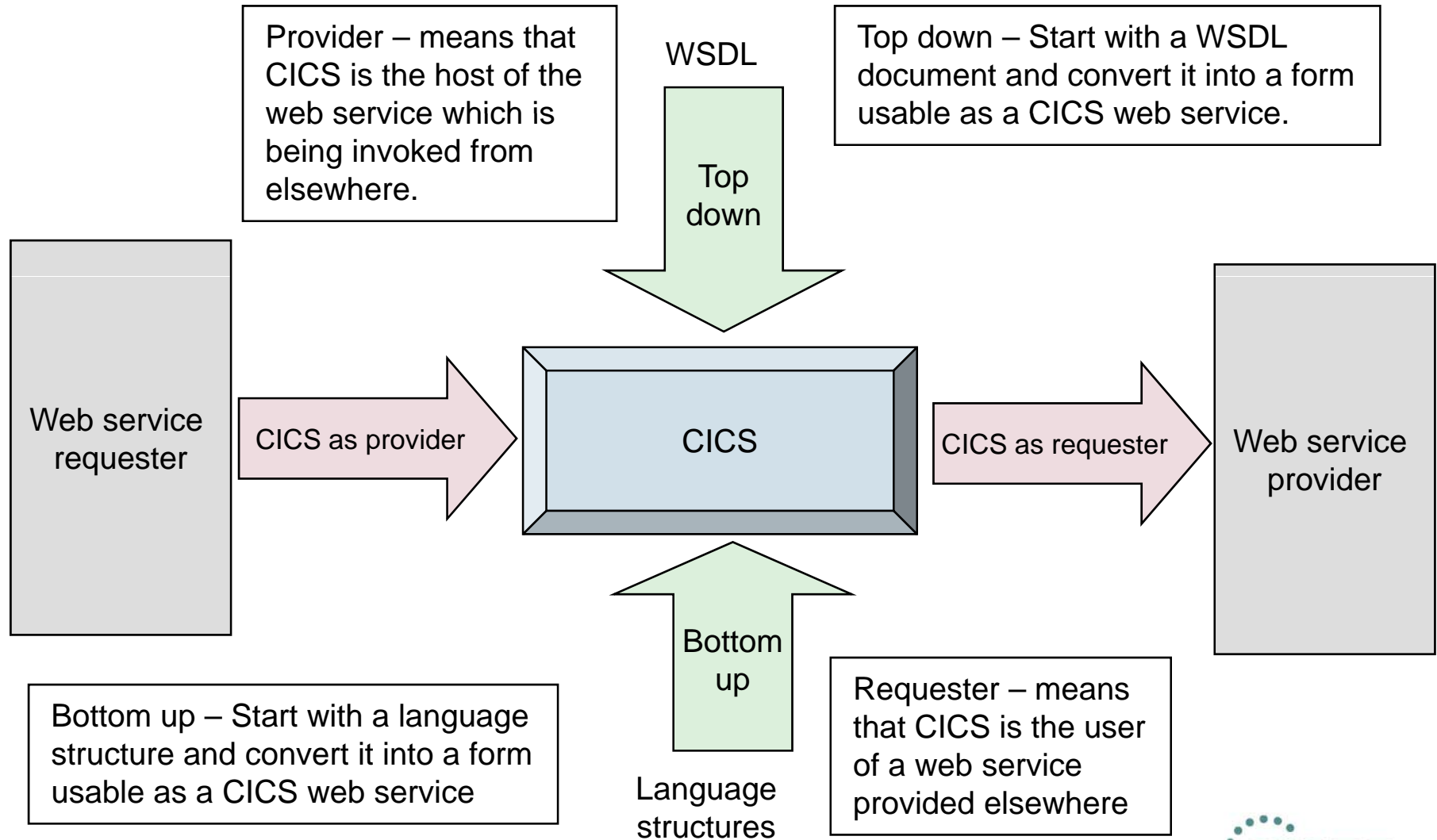



# Approach to web services development (2 of 2)

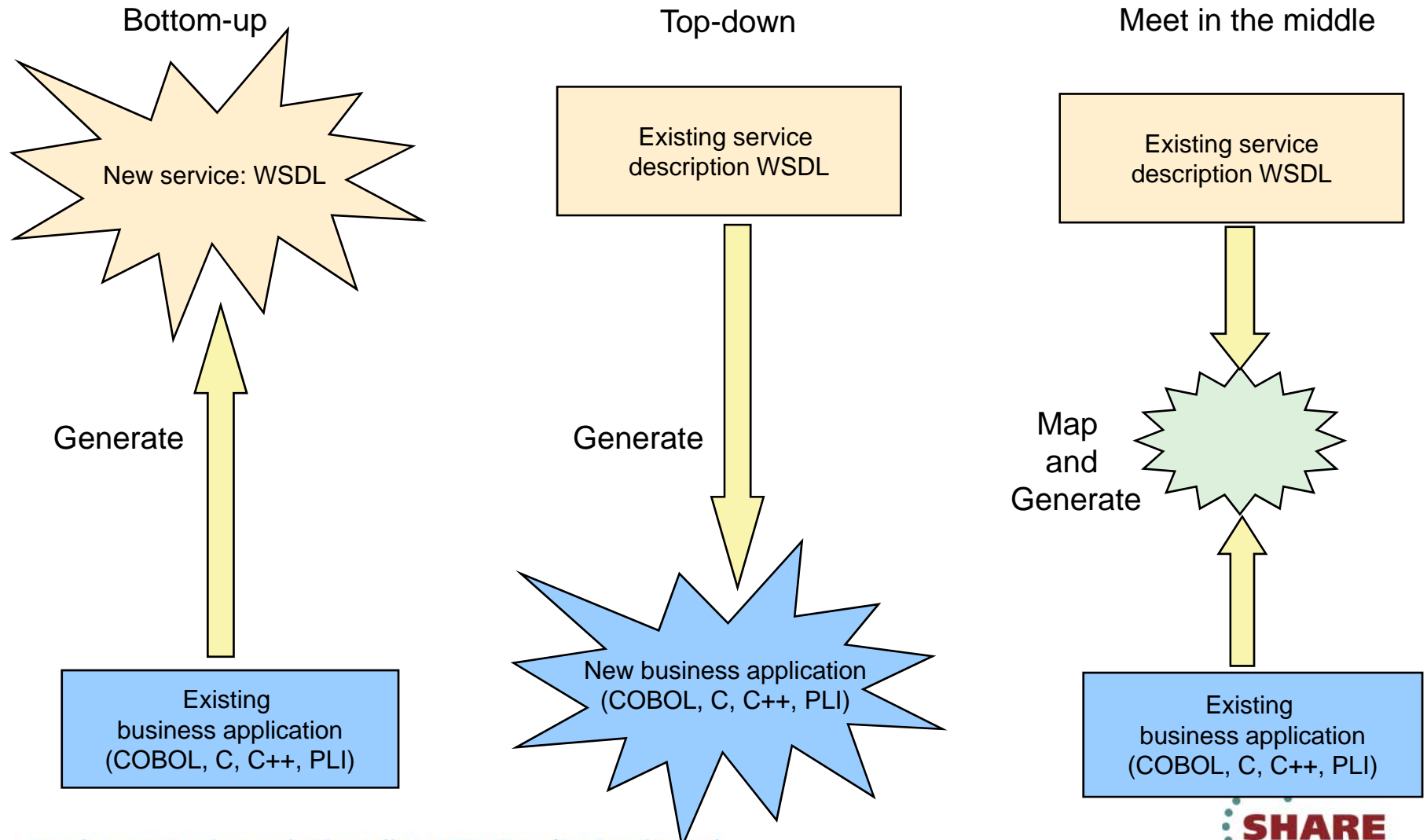

## CICS web services assistant

- Web services assistant is a set of batch utilities which can help you to transform existing CICS applications into web services and to enable CICS applications to use web services provided by external providers.
- The CICS web services assistant comprises two utility programs:
  - DFHLS2WS generates a web service binding file from a language structure. This utility also generates a web service description.
  - DFHWS2LS generates a web service binding file from a web service description. This utility also generates a language structure that you can use in your application programs.

# Rational Developer for System z

- Web Services and XML development
  - Offers the ability to create, view, edit and validate WSDL, document-type definitions (DTD) and XML schemas, transforms XML documents into text, HTML, or other XML document types.
  - Integrates relational databases and XML.
  - Generates COBOL adapters and CICS TS V3 WSBind and COBOL artifacts for converting between Web Service Definition Language.
- The CICS service flow feature provides components that extend CICS Transaction Server by providing adapters that exploit CICS interfaces to invoke the CICS terminal-oriented transactions and COMMAREA programs required by the web service generated from the service flow project.

# CICS Service Flow Modeler

- At build time, a developer uses the Service Flow Modeler for the following tasks:
  - Model a newly composed business service or flow using processes or services and their interfaces.
  - Capture existing enterprise information system (EIS) interfaces, such as screens or communication areas.
  - Generate adapters to and from interfaces, supporting both the accumulation of information that is used in request and response processing, as well as data transformation activities between the flow and the interface.
  - Expose business flows as a service.
- At run time, a service requester invokes the deployed adapter service to perform a business function as modeled in the CICS Service Flow Modeler.

## Web services: Pipeline

- What is a CICS pipeline?
  - Responsible for dealing with SOAP headers
  - Implemented as a series of programs
  - Can be configured by end user by using message handlers
- A message handler is a program in which you can perform your own processing of web service requests and responses.
- A pipeline is a set of message handlers that are executed in sequence.

# Web services: PIPELINE resource definition



```
>>-PIPELINE (name) --GROUP (groupname) --+-----+----->
                                     '-DESCRIPTION (text) -'

                                     .-SHELF (/var/cicsts) -.
>--CONFIGFILE (name) --+-----+----->
                                     '-SHELF (directory) ---'

                                     .-STATUS (ENABLED) --.
>--+-----+-----+-----+----->
                                     '-STATUS (DISABLED) -'   '-RESPWAIT (number) -'

>--+-----+----->X
                                     '-WSDIR (directory) -'
```

- CONFIGFILE(*name*) specifies the name of a z/OS UNIX file that contains information about the processing nodes that will act on a service request, and on the response.
- SHELF({/var/cicsts/|*directory*}) specifies the 1–255 character fully-qualified name of a directory (a *shelf*, primarily for web service binding files) on z/OS UNIX.
- WSDIR(*directory*) specifies the 1–255 character fully-qualified name of the *web service binding directory* (also known as the *pickup directory*) on z/OS UNIX.

## Pipeline configuration file

- The pipeline configuration file, named in a PIPELINE resource definition, is used to describe the series of message handlers to process the request.
- The configuration file is an XML document, stored in HFS and can be edited with any XML editor.
- The configuration file will contain mandatory `<service>` and optional `<transport>` elements along with application handler `<apphandler>` and a service parameter list `<service_parameter_list>`.

# Pipeline XML configuration for a service provider

```
<?xml version="1.0" encoding="EBCDIC-CP-US"?>
<provider_pipeline
  xmlns="http://www.ibm.com/software/htp/cics/pipeline">
  <service>
    <terminal_handler>
      <cics_soap_1.1_handler/>
    </terminal_handler>
  </service>
  <apphandler>DFHPITP</apphandler>
</provider_pipeline>
```



## WEBSERVICE resource definition

- The WEBSERVICE resource defines aspects of the run time environment for a CICS application program deployed in a web services setting.
- The aspects of the run time environment that are defined by the WEBSERVICE resource definition are:
  - Pipeline resource definition: Defines the set of message handlers that operate on Web Service requests and responses.
  - Web Service binding file: A file which contains information that CICS uses to map data between input and output messages, and application data structures.
  - Web Service description: Used only when runtime validation of SOAP messages is required.

# Web services: URIMAP resource definition

```

Urimap          ==>
Group           ==>
DEscription     ==>
SStatus        ==> Enabled
USAge         ==> Pipeline
UNIVERSAL RESOURCE IDENTIFIER
SCheme         ==> HTTP
POrt           ==> No
HOST           ==>
(Mixed Case)   ==>
PAtH           ==>
(Mixed Case)   ==>
               ==>
               ==>
               ==>
...
ASSOCIATED CICS RESOURCES
TCpipservice   ==>
ANalyzer       ==> No
COnverter      ==>
TRansaction    ==>
PRogram        ==>
PIpeline     ==>
Webservice  ==>

```

- The URIMAP definition is used to match a URI to a WEBSERVICE definition and a PIPELINE definition.
- You should have a unique URI for each web service that you want to use in CICS.
- The parameters that apply to a web service form of the URIMAP are:
  - USAGE (PIPELINE) parameter indicates that the URIMAP definition is applicable to a web service and that the PIPELINE and WEBSERVICE parameters must be specified.
  - The PIPELINE parameter names an installed PIPELINE resource which will be used to determine the processing nodes or message handlers that will be invoked for this web service request.
  - The WEBSERVICE parameter names an installed WEBSERVICE resource that defines the execution environment that lets a CICS application program operate as a web service provider or requester.

# Web services: WEBSERVICE resource definition

```
>>--WEBSERVICE (name) --GROUP (groupname) ---+-----+----->
                                     '-DESCRIPTION (text) -'

>--PIPELINE (pipelinename) --WSBIND (hfsfile) ----->

  .-VALIDATION (NO) --.
>--+-----+-----+-----+-----><
  '-VALIDATION (YES) -'   '-WSDLFILE (hfsfile) -'
```

- PIPELINE(*pipelinename*) specifies the 1-8 character name of the PIPELINE with which this WEBSERVICE is associated.
- VALIDATION(NO | YES) specifies whether full validation of SOAP messages against the corresponding schema in the web service description should be performed at run time.
- WSBIND(*hfsfile*) specifies the 1-255 character fully-qualified file name of the Web Service binding file on z/OS UNIX.
- WSDLFILE(*hfsfile*) specifies the 1-255 character fully-qualified file name of the Web Services Description Language (WSDL) file on z/OS UNIX. This file is used when full runtime validation is active.

# Web service resource interrelationships

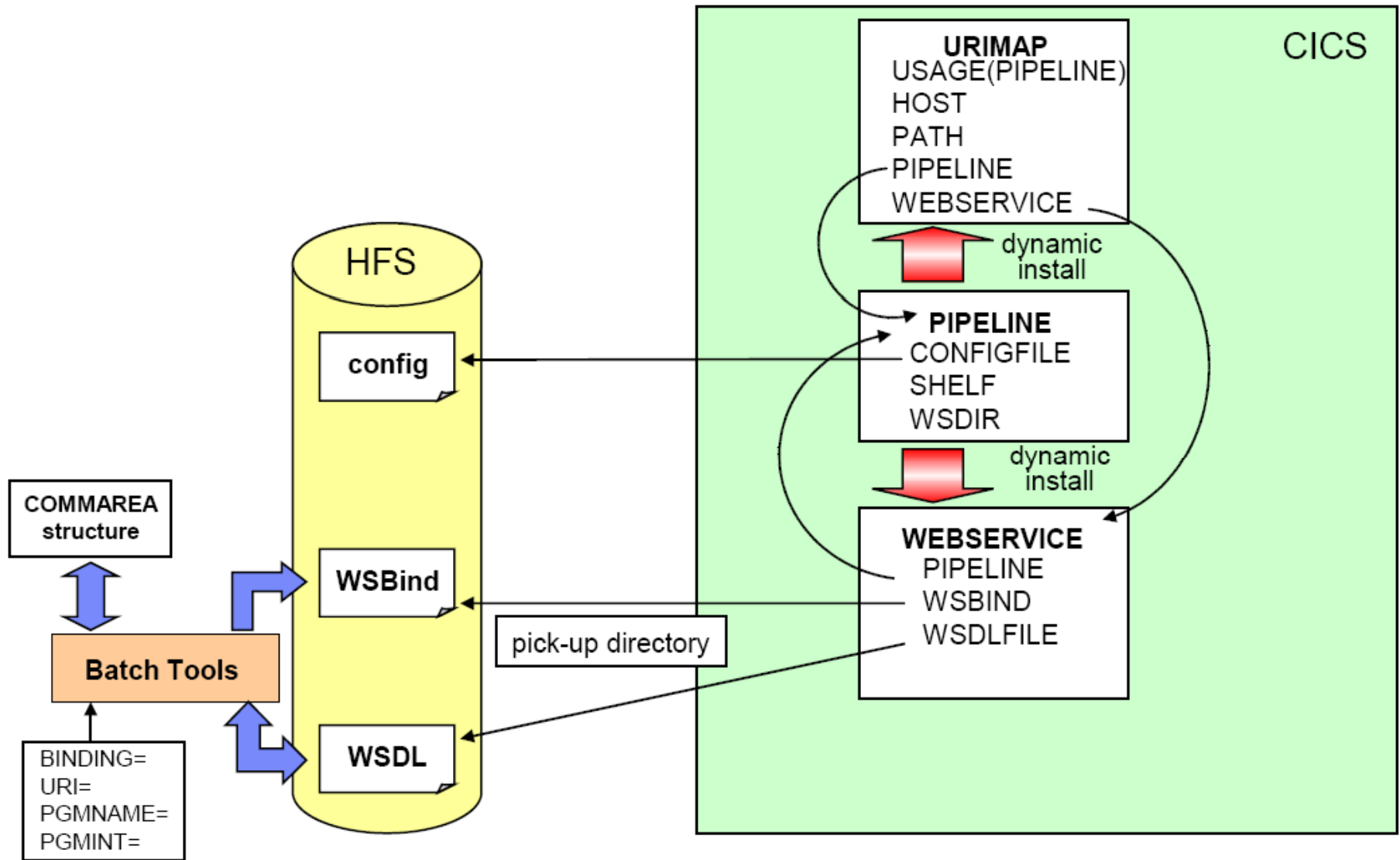

soapUI 4.0.1

File Tools Desktop Help

Search Forum

Navigator

- Projects
  - Ezriel
    - PAYBUSHTTPSoapBinding
      - PAYBUSOperation
        - PAYBUSOperation test

Submit request to specified endpoint URL

```
<SOAP-ENV:Envelope xmlns:pay="http://www.PAYBUS.PAYCOM.Request.com" xmlns:SOAP-ENV="http://schemas.xmlsoap.org/soap/envelope/">
  <SOAP-ENV:Body>
    PAYBUSOperation xmlns="http://www.PAYBUS.PAYCOM.Request.com">
      <ws_payroll_data>
        <ws_request>DISP</ws_request>
        <ws_key>
          <ws_department>1</ws_department>
          <ws_employee_no>00001</ws_employee_no>
        </ws_key>
        <ws_name/>
        <ws_addr1/>
        <ws_addr2/>
        <ws_addr3/>
        <ws_phone_no/>
        <ws_timestamp/>
        <ws_salary/>
        <ws_start_date/>
        <ws_remarks/>
        <ws_msg/>
        <ws_upd_inde>
          <ws_upd_name/>
          <ws_upd_addr1/>
          <ws_upd_addr2/>
          <ws_upd_addr3/>
          <ws_upd_phone_no/>
          <ws_upd_salary/>
          <ws_upd_start_date/>
          <ws_upd_remarks/>
        </ws_upd_inde>
        <ws_browseq/>
        <ws_update_ind/>
        <ws_delete_ind/>
        <ws_add_ind/>
        <ws_error_ind/>
        <ws_browse ind/>
      </ws_payroll_data>
    </PAYBUSOperation>
  </SOAP-ENV:Body>
</SOAP-ENV:Envelope>
```

Interface Properties

Property	Value
Name	PAYBUSHTTPSoapBi...
Description	
Definition URL	file:/C:/Documents...
Binding	{http://www.PAYBU...
SOAP Version	SOAP 1.1

Properties

Aut Headers (0) Attachments (0) WS-A WS-RM JMS Headers JMS Property (0)

response time: 10721ms (2461 bytes)

1 : 5

soapUI log http log jetty log error log wsrm log memory log



SOAP  
request

soapUI 4.0.1

File Tools Desktop Help

Search Forum

Navigator

- Projects
  - Ezriel
    - PAYBUSHTTPSoapBinding
      - PAYBUSOperation
        - PAYBUSOperation test

Request Properties

Property	Value
Name	PAYBUSOperation test
Description	
Message Size	2928
Encoding	UTF-8
Endpoint	http://ctrek.dal-ebis...

Properties

PAYBUSOperation test

http://ctrek.dal-ebis.ihost.com:6000/paybus

```
<SOAP-ENV:Envelope xmlns:soapenv="http://schemas.xmlsoap.org/soap/envelope/" xmlns:pay="http://www.PAYBUS.PAYCOM.Response.com">
  <SOAP-ENV:Body>
    <PAYBUSOperationResponse xmlns="http://www.PAYBUS.PAYCOM.Response.com">
      <ws_payroll_data>
        <ws_request>DISP</ws_request>
        <ws_key>
          <ws_department>1</ws_department>
          <ws_employee_no>00001</ws_employee_no>
        </ws_key>
        <ws_name>CIRCLE EDUCATION LTD</ws_name>
        <ws_addr1>QUEBENSBURY HSE</ws_addr1>
        <ws_addr2>BRIGHTON</ws_addr2>
        <ws_addr3>SUSSEX</ws_addr3>
        <ws_phone_no>75529900</ws_phone_no>
        <ws_timestamp/>
        <ws_salary>1234.56</ws_salary>
        <ws_start_date>28101984</ws_start_date>
        <ws_remarks>CIRCLE IS MAGIC</ws_remarks>
        <ws_msg/>
        <ws_upd_inds>
          <ws_upd_name/>
          <ws_upd_addr1/>
          <ws_upd_addr2/>
          <ws_upd_addr3/>
          <ws_upd_phone_no/>
          <ws_upd_salary/>
          <ws_upd_start_date/>
          <ws_upd_remarks/>
        </ws_upd_inds>
        <ws_browseseq/>
        <ws_update_ind/>
        <ws_delete_ind/>
        <ws_add_ind/>
        <ws_error_ind/>
        <ws_browse_ind/>
        <ws_dept_ind/>
        <ws_l_count>0</ws_l_count>
        <ws_l_tot>0</ws_l_tot>
      </ws_payroll_data>
    </PAYBUSOperationResponse>
  </SOAP-ENV:Body>
</SOAP-ENV:Envelope>
```

Headers (5) Attachments (0) SSL Info WSS (0) JMS (0)

response time: 10721ms (2461 bytes)

1 : 5

soapUI log http log jetty log error log wsrm log memory log



# CICS Transaction Server runtime support and specifications

- Runtime support for:
  - WSDL V1.1
  - SOAP V1.1 and SOAP V1.2
  - WS-I Basic Profile V1.1
  - XML V1.0
  - WS-I Simple SOAP Binding Profile V1.0
- Specifications:
  - WSDL V1.1 specification:  
<http://www.w3.org/TR/wsdl>
  - SOAP V1.1 specification:  
<http://www.w3.org/TR/2000/NOTE-SOAP-20000508/>
  - SOAP V1.2 specification:  
<http://www.w3.org/TR/soap12-part0/>
  - WS-I Basic Profile V1.1:  
<http://www.ws-i.org/Profiles/BasicProfile-1.1-2004-08-24.html>
  - XML V1.0 specification:  
<http://www.w3.org/TR/2004/REC-xml-20040204/>
  - WS-I SSBP V1.0 specification:  
<http://www.ws-i.org/Profiles/SimpleSoapBindingProfile-1.0-2004-08-24.html>

## Summary

- Web services in CICS build on established CICS concepts and technologies such as pseudoconversational transactions and program-to-program communication via COMMAREAs (or channels and containers)
- Web services introduce new concepts and technologies such as XML, SOAP, and WSDL
- Web services involve a combination of CICS resource definitions (PIPELINE, WEBSERVICE, URIMAP)
- CICS TS provides utilities for converting existing CICS applications into web services
- IBM provides other tools to help develop web services

