



z/OS Communications Server

The Evolution of SNA: z/OS CS Enterprise Extender Hints & Tips



z/OS CS Design & Development, Raleigh



© Copyright International Business Machines Corporation 2012. All rights reserved.

Sam Reynolds - samr@us.ibm.com

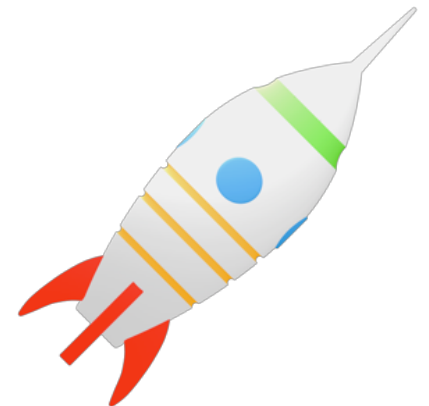

SHARE 2012 Winter Technical Conference
Session 10822

What is Enterprise Extender?

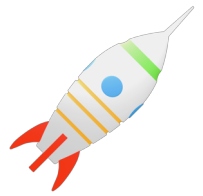

- Allows use of IP network for SNA sessions
- EE allows enablement of IP applications and convergence on a single network transport while preserving SNA application and endpoint investment.
- Typically isolates SNA footprints to the "outside" of the network.

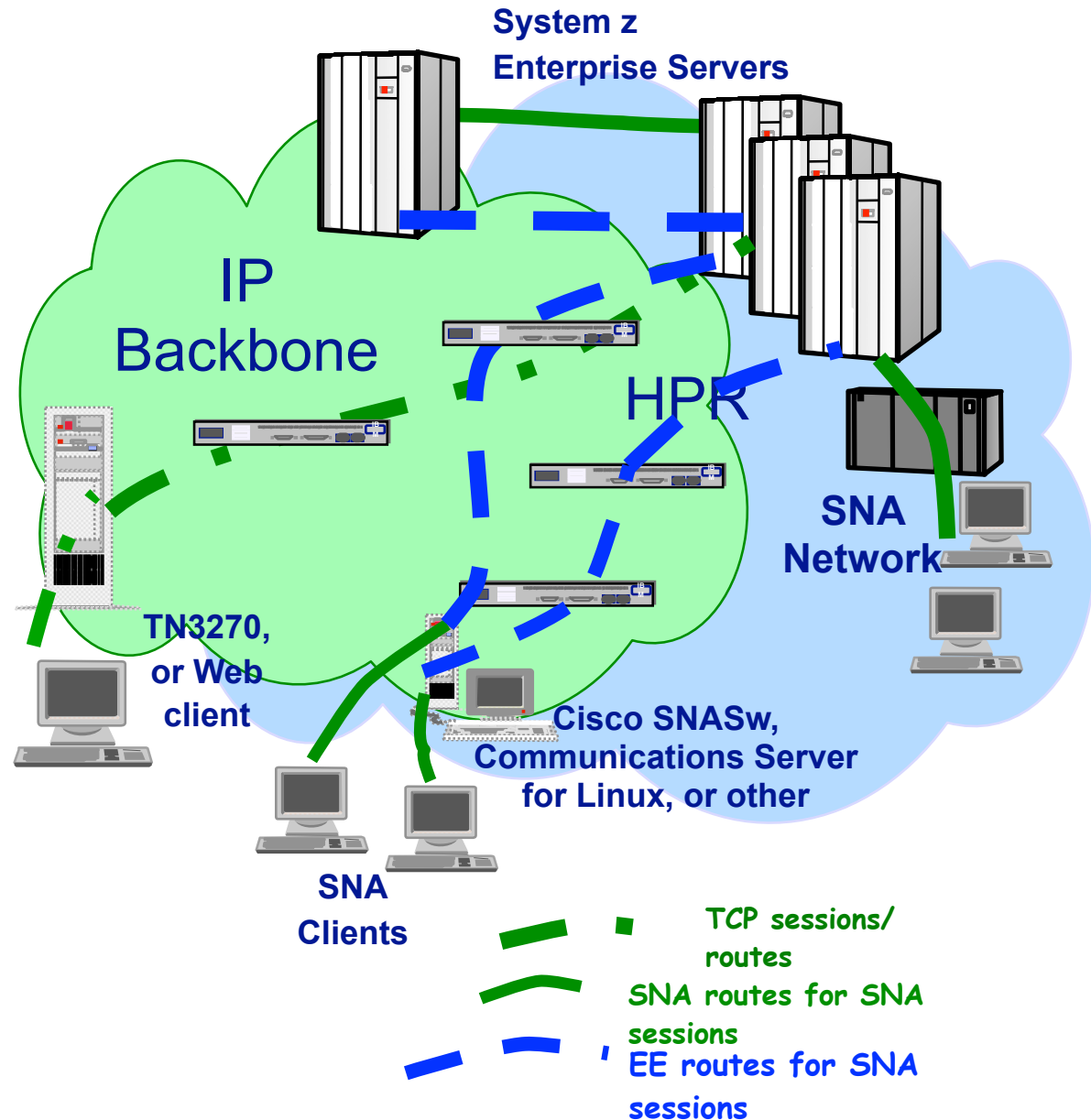

APPN Ships on VTAM V4R1
1988



VTAM Adds HPR RTP Support (VTAM V4R2)
1989



OS/390 OS Delivers EE (V2R1)
1989



Key HPR/Subarea Restriction Lifted (OS/390 V2R1Q)
1989

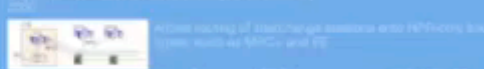

Substantial EE Enhancements in z/OS V1R6-Q2
2002



EE Connection Network Reachability Awareness (z/OS V1R6)
2004



Path MTU Discovery Provided in z/OS V1R10
2008

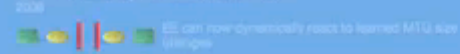

Progressive Mode ARB W1 Ship in z/OS V1R11
2008



EE Health Verification in z/OS V1R12
2011



EE Intrusion Detection Services Support
2011



First APPN Products Ship
1988
First shipped on S/OS and AS/400

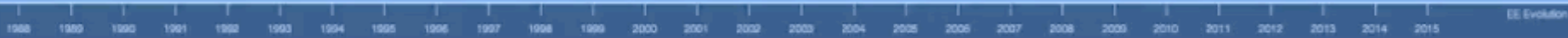

APPN Ships on VTAM V4R1
1993



VTAM provides APPN/Subarea integration with ICN and CAN capabilities

VTAM Adds HPR RTP Support (VTAM V4R2)
1995



HPR brings non-destructive route-switching capabilities to SNA

O6/390 CS Drives EE (V2R7)
1999



EE initially shipped on V2R7, with an enhancement PTF to V2R9

Key HPR/Subarea Restriction Lifted (O6/390 V2R10)
2000

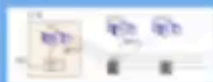

Allows routing of crossrange sessions onto HPR-only links (zoes, such as MPC+ and EE)

Substantial EE Enhancements in z/OS V1R6 CS
2003



- Multiple connection network support
- EE IPv6 support
- EE connection network compatibility with NAI

EE Connection Network Reachability Awareness (z/OS V1R6)
2004



Improved reliability of connection network for EE

Path MTU Discovery Provided in z/OS V1R10
2008

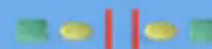

EE can now dynamically react to changes

Progressive Mode APB Wk Shp in z/OS V1R10
2008

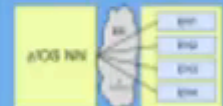

Improves throughput between z/OS Link

EE Health Verification in z/OS V1R10
2008



EE Intrusion Detection (2011)



ipped on S/39 and AS/400



First APPN Products Ship
1988

APPN

ADVANCED PEER-TO-PEER NETWORKING

First shipped on S/36 and AS/400

1988

1989

1990

1991

1992

1993

1994

1995

1996

1997

1998

1999

2000

2001

2002

2003

2004

2005

2006

2007

2008

2009

2010

2011

2012

2013

2014

2015

2016

2017

2018

2019

2020

2021

2022

2023

2024

2025

2026

2027

2028

2029

2030

2031

2032

2033

2034

2035

2036

2037

2038

2039

2040

2041

2042

2043

2044

2045

2046

2047

2048

2049

2050

APPN Ships on VTAM V4R1 1993

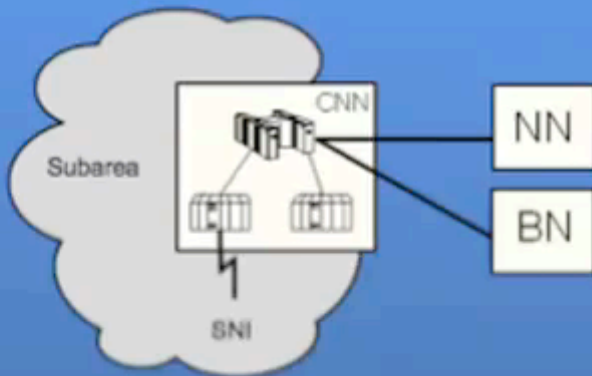

VTAM provides APPN/Subarea integration with ICN and CNN capabilities

VTAM V4R1 1995



HPR brings non-disruptive route-altering
SNA

OS/390 CS Delivers EE (V2R7) 1999



EE initially eclipsed by V2R7, with an enhanced RTG
V2R6

OS/390 CS Delivers EE (V2R7) 1999



EE initially eclipsed by V2R7, with an enhanced RTG
V2R6

M V4R1

NN

BN

VTAM provides APPN/Subarea Integration with ICN and CNN capabilities

EE Connection Network Reachability Awareness (OS/390 V1R6) 2004



Improved reachability of connection network to EE

Fixed MTU Discovery Provided in zOS V1R6 2008

VTAM Adds HPR RTP Support (VTAM V4R3)

1995

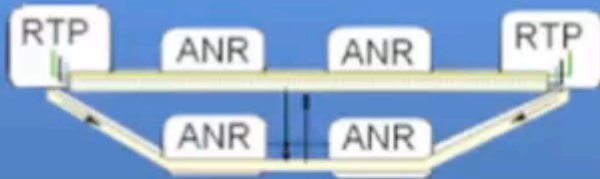

HPR brings non-disruptive route-switching capabilities to SNA

1999



EE Initially Stripped on V4R1, with EE Support in V2R6

Key HPR/Subarea Restriction Lifted (OS/390 V2R10) 2000

Allows routing of interchange sessions onto HPR-only link types, such as MPC+ and EE



EE Interchange Session Service Layer (2001)



4R3)

Non-disruptive route-switching capabilities to



Security Awareness (z/OS V1R6)

Improved reliability of connection network for EE

Path MTU Discovery Provided in z/OS V1R6
2000

EE can now dynamically react to network MTU size changes

z/OS/390 CS Delivers EE (V2R7) 1999

EE initially shipped on V2R7, with an enablement PTF to V2R6

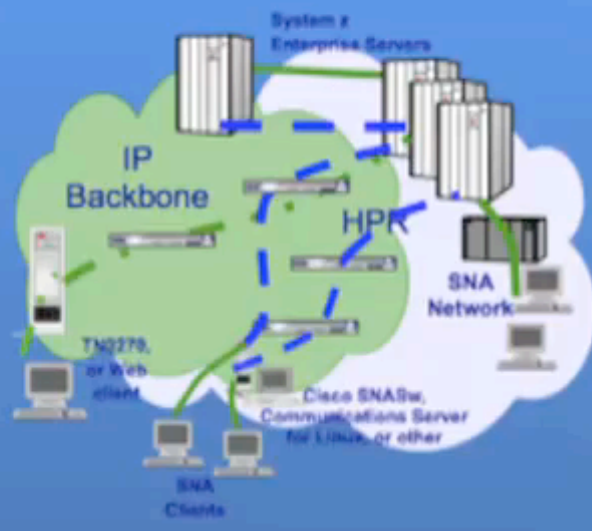

Key HPRV3000 2000

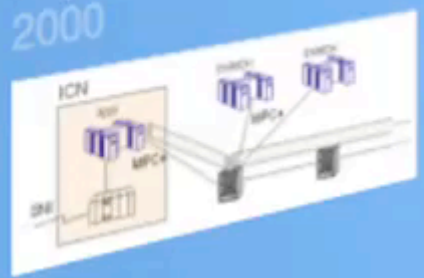

Allows routing of interchange connections between types, such as MPC+ and EE

Substantial EE Enhancements in z/OS V1R6 CS 2003

- Multiple connection network support
- EE IPv6 support
- EE connection network compatibility with IPv4

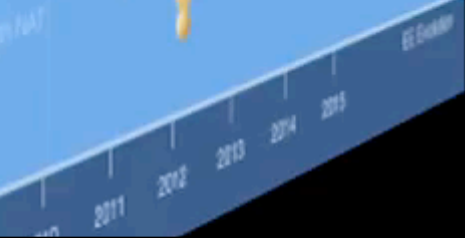

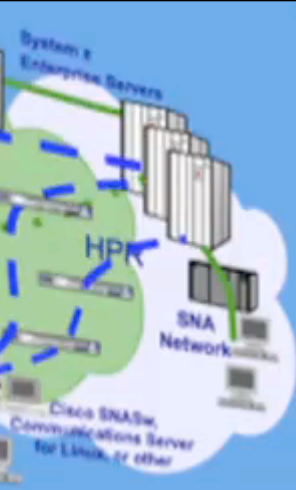

EE initially shipped on V2R7, with an enablement PTF to V2R6

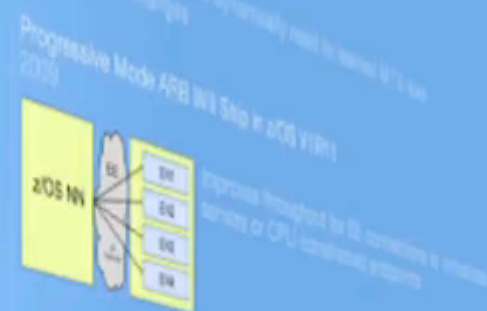

EE Health Verification in zOS V1R12 (2010)



Key HPR/Subarea Restriction Lifted (OS/390 V2R10) 2000

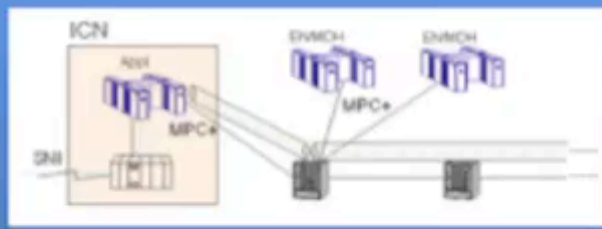

Allows routing of interchange sessions onto HPR-only link types, such as MPC+ and EE



- Multiple connections
- EE IPv6 support
- EE connection network compatibility with NAT

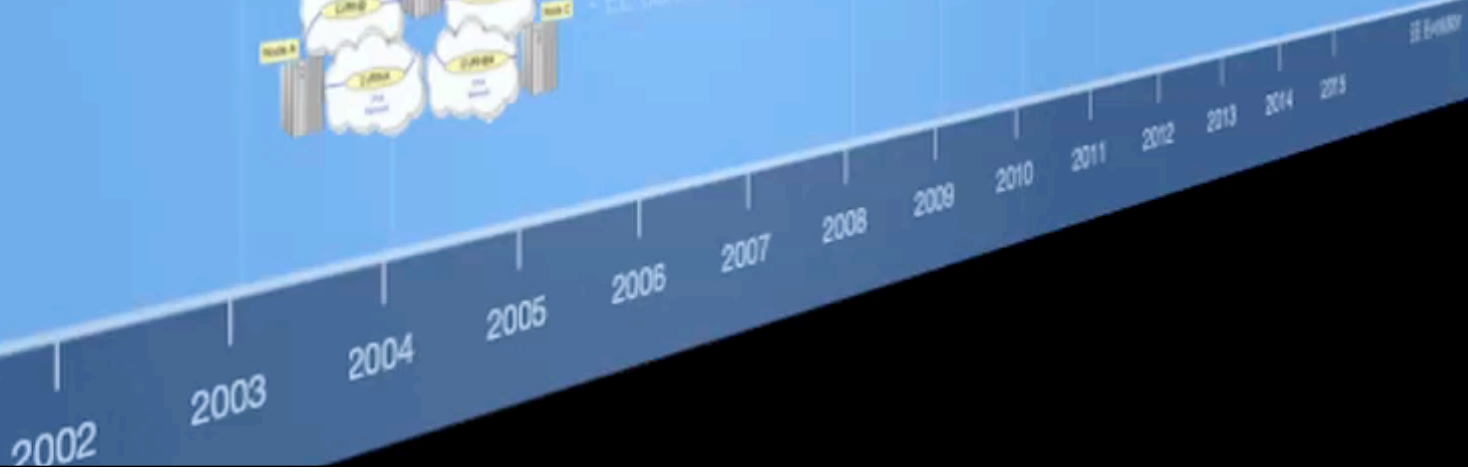

Restriction Lifted (OS/390 V2R10)

Allows routing of interchange sessions onto HPR-only link types, such as MPC+ and EE



EE Health Verification in z/OS V1R12
2010

EE Intrusion Detection Review

Substantial EE Enhancements in z/OS V1R5 CS 2003



- Multiple connection network support
- EE IPv6 support
- EE connection network compatibility with NAT



EE Connection Network Reachability Awareness (z/OS V1R6) 2004

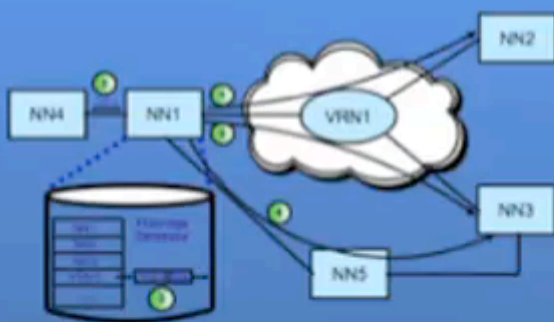

Improved reliability of connection network for EE

Progressive Move of EE 2009

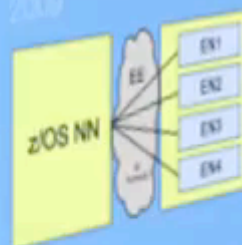

Improved throughput for EE connections to virtual servers or CPU-constrained endpoints

EE Health Verification in z/OS V1R12 2010



Awareness (z/OS V1R6)

Reliability of connection network for EE

Path MTU Discovery Provided in z/OS V1R10 2008



EE can now dynamically react to learned MTU size changes

Progressive Mode ARB Will Ship in z/OS V1R11 2009

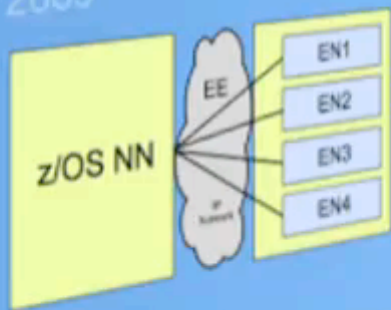

Improves throughput for EE connections to virtualized servers or CPU-constrained endpoints

EE Health Verification in z/OS V1R12 2010



V1R6)
Connection network for EE
TU Discovery Provided in z/OS V1R10

EE can now dynamically react to learned MTU changes

Progressive Mode ARB Will Ship in z/OS V1R11 2009

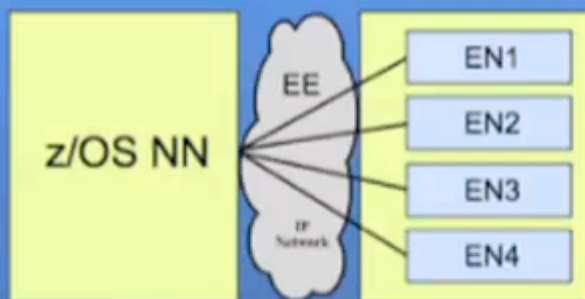

Improves throughput for EE connections to virtualized servers or CPU-constrained endpoints

EE Health Verification
2010



Connection Detection Services Support

EE can now dynamically react to learned MTU size changes

Progressive Mode ARB Will Ship in z/OS V1R11
2009

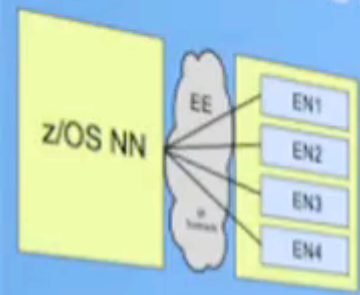

Improves throughput for EE connections to virtualized servers or CPU-constrained endpoints

EE Health Verification in z/OS V1R12
2010



EE Intrusion Detection
2011



HPR-only link

V1R5 CS

network support

NAT

EE Evolution



EE Intrusion Detection Services Support 2011



work support
compatibility with NAT



2010 verification in z/OS VIR12

EE Intrusion

EE Recommendations

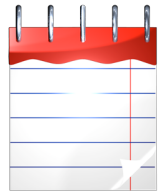

- #1 problem in bringing up EE connections: Firewall issues.

- Any underlying firewall must allow the transport of UDP ports 12000-12004 (possibly limited to known EE endpoint addresses)

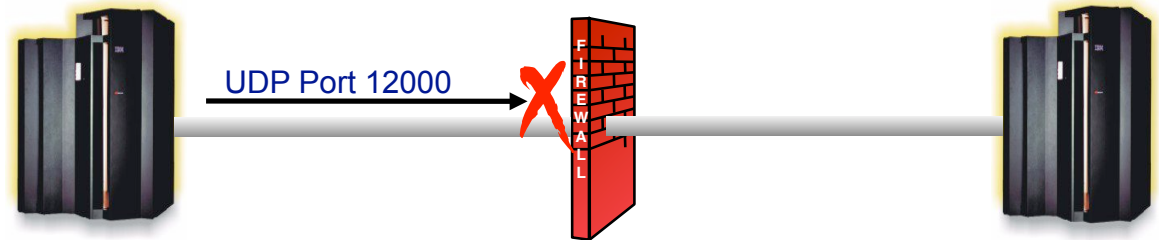

- Consider enabling PSRETRY (off by default) so that HPR pipes will automatically switch to better routes when available.

- PSRETRY is usually of value only when alternate APPN routes exist.

- Consider enabling HPR Path Switch Summarization.

- Configure APPN Link Characteristics

- TGPs for EE provided with VTAM - Customization of link speed is recommended

EE Recommendations...

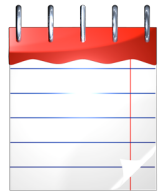

- Consider lengthening the EE LDLC timer parameters (LIVTIME, SRQTIME, SRQRETRY).
 - It is recommended that the LDLC timer parameters be adjusted on both ends of the connection.
- Lengthen HPR path switch timers (HPRPST) as necessary to ensure that all four timers are longer than the LDLC timeout interval.
 - This will ensure that RTP pipes stay in path switch long enough during IP network instability to allow the EE link to inop, and thereby allow another path to be selected.
 - If multiple LDLC parameter sets are in use (by coding different LIVTIME, SRQTIME, and SRQTIME values on different XCA GROUPs), then the HPRPST values should be adjusted relative to the longest of the LDLC timeout intervals.
- If defining an EE Connection Network over an IP network which employs Network Address Translation (NAT), you must define the virtual routing node's addressability using the HOSTNAME operand (not the IPADDR operand).
- APAR OA35305 provides more robust hostname resolution after a VTAM restart and is recommended maintenance.

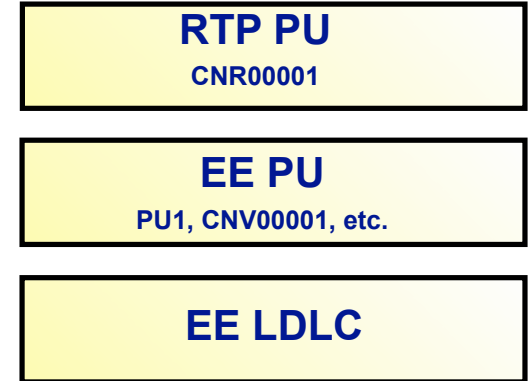

EE/HPR Timer Notes

NOTES

- The EE LDLC layer monitors the connection, testing it if no activity is detected, and inop'ing the EE link if the tests go unanswered
 - Total LDLC timeout interval = $LIVTIME + ((SRQRETRY+1) * SRQTIME)$
- The Disconnect timer associated with the EE switched PU is used to trigger an inop if no activity is detected for a specified amount of time
- The RTP layer is responsible for driving status requests frequently enough (in the absence of data traffic) to keep the disconnect timer from tripping. The RTP endpoint will inop itself if its last session goes away, and no new session is queued to it for a period of 10 seconds (or the period specified in the RTP model, if used)
- The path switch timer (set by HPRPST) controls the amount of time that an RTP pipe will stay in path switch state, trying to find an alternate route, before abandoning the attempt and inactivating the pipe.

EE XCA Major Node Recommendations

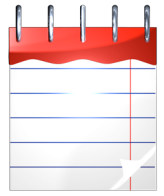

- Define all of your EE connection networks on the GROUP statements, and not on the XCA PORT. This will provide more consistent definitions as your connection networks expand in the future, and positions you to utilize GROUP-based configuration options.

- Having GROUP-based definitions also enables more flexible and less disruptive updating of the EE XCA definitions via the VARY ACT,UPDATE=ALL command

```
DEMOXCA  VBUILD  TYPE=XCA
DEMOPORT  PORT    MEDIUM=HPRIP
*
DEMOGRP   GROUP   DIAL=YES,CALL=INOUT,                                X
                                     AUTOGEN=(5, EV4, P), DYNPU=YES, ISTATUS=ACTIVE
*****
* EXAMPLE VRN                                                    *
*****
DEMOVRN   GROUP   DIAL=YES,CALL=INOUT, VNNAME=NETA.LVRN,          X
                                     AUTOGEN=(5, LV01, P), DYNPU=YES, VNTYPE=LOCAL,
                                     HOSTNAME=TUVIPA2.AREA51.SVT390.COM,
                                     ISTATUS=INACTIVE, TGP=GIGENET                                X
```

- Leave the IPPORT operand at its default of 12000. If you change it, you must change it on all EE platforms that you connect to, and some do not support such a change.
- The IPTOS operand on the PORT is used to set the values for the IP Type of Service byte for each of the five EE priorities (low, medium, high, network, and signal).
 - Default: IPTOS=(20,40,80,C0,C0)
 - However: Only the three highest-order bits can be set! Any attempt to set any of the lower five bits in the byte will result in an “invalid parameter” error message
 - The full TOS byte can be customized by using the policy agent

Effect of IP Multipath on EE

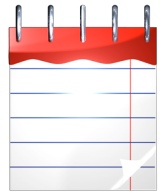

- The IPCONFIG MULTIPATH parameter in the TCP/IP profile enables the multipath routing selection algorithm for outbound IP traffic. (The default is NOMULTIPATH.)
 - When MULTIPATH is enabled, there are two options to choose between: PERCONNECTION and PERPACKET, with PERCONNECTION being the default choice.
 - If MULTIPATH is enabled, the choice of PERCONNECTION vs. PERPACKET makes no difference for EE.
 - In either case, IP will use a "per-batch-of-packets-from-VTAM" approach.
 - Since there is no "UDP connection", true PerConnection multipath is really not possible
 - PerPacket is too granular as it leads to too much resequencing overhead at the RTP receiving endpoint.
 - **Recommendation:**
 - z/OS V1R11 CS and earlier: If you already have MULTIPATH enabled for your TCP applications, there is no requirement to change it. But in general, MULTIPATH is probably not a particularly good idea for EE as it often leads to extra resequencing overhead at the receiver.
- z/OS V1R12 CS: Leave the VTAM start option MULTIPATH set to the default value of NO

EE Connection Network

- A connection network is an APPN technology that reduces the need for predefining APPN links between nodes that are connected to a shared transport
 - With EE, the IP network itself is the shared transport.
- The shared transport (IP network in the EE case) is represented as an APPN Virtual Routing Node (VRN).
- All EE nodes participating in the connection network can send EE packets directly to each other without defining links to all the other participating nodes.
 - Connections are dynamically defined between VRN partners as needed.
- Generally the combination of EE with connection network technology is recommended with the objective of reducing the amount of link definitions that are required and to allow EE endpoint to endpoint communication to flow directly between the associated IP endpoints.

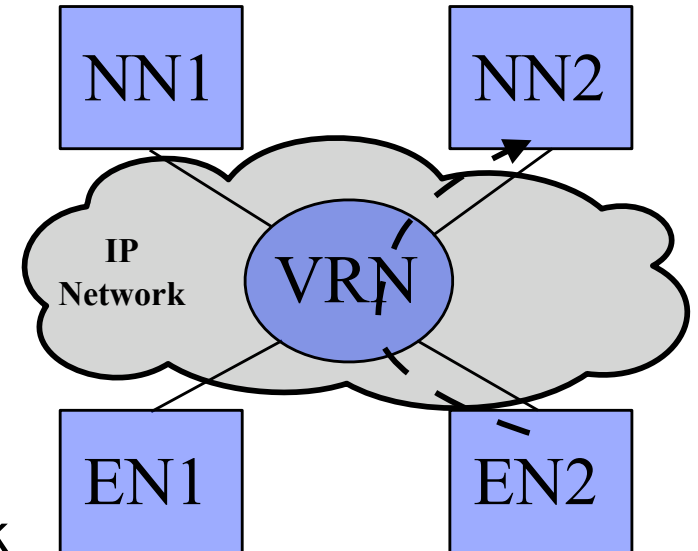

Example: Since EN2 and NN2 both define the VRN, a dynamic connection can be activated between them over the VRN without predefining a static EN2-to-NN2 connection

EE Connection Network Tips

- A limited set of characteristics of the dynamic connection can be customized by coding a DYNTYPE=VN PU entry in the model major node:

```
MODEL1A VBUILD TYPE=MODEL
*
VNMODEL PU DYNTYPE=VN,
DISCNT=NO
```

- The primary use of the DYNTYPE=VN model is to customize the DISCNT value.
- TG characteristics cannot be specified on a DYNTYPE=VN model PU
 - The DYNTYPE=VN model defines the dynamic PU used for the actual VN connection, not the virtual routing node (VRN) and its associated TGs. The TG created with the dynamic PU is not reported to Topology and Routing Services and is not involved in route calculations. To configure the weight of the TGs associated with the VRN, specify the TG characteristics on the GROUP statements in the XCA major node.
 - Consider coding a DYNTYPE=VN model, with DISCNT=NO, or a delay value of 60+ seconds.
 - **Important note for CICS LU6.2 Users:** Specifying DISCNT=NO will prevent CICS from terminating its sessions at the end of every transaction.
- For any APPN TG to be activated, whether predefined or dynamically-activated (as is usually the case with connections associated with connection networks), an ADJCP entry must exist. If no ADJCP entry is coded for the partner CP, and DYNADJCP=NO, then the APPN connection activation will fail. So, to allow connection network connectivity you must set DYNADJCP=YES, or code ADJCP definitions for the partner CPs.
 - This provides a mechanism to control which partners are allowed to connect to your CP

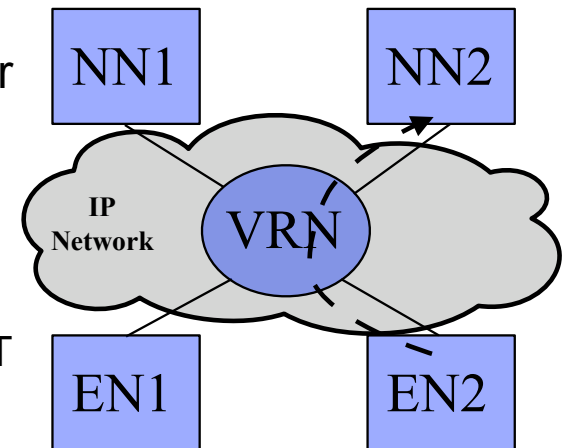

Connection Network Failures

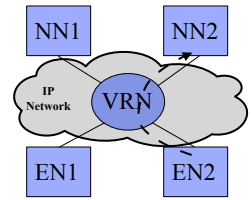

- Typical VRN Configuration

- ENs predefine links to NNS for CP-CP
- Dynamic CN links used EN-to-EN

- What happens if IP network fails?

- Affected RTPs begin path switching
- VRN path is chosen again
 - Topology component is **not** notified of the failure
 - VRN path still has lowest weight
- Path switch fails even though a functional alternate path exists (through NN)

- VRN-specific message issued:

- For VRN dial failures and VRN link INOPs
 - IST1903I - Identifies the VRN and partner node
- Can be used to drive automation that quiesces the VRN or increases the weight of the link to the VRN

IST1903I FAILURE OVER VRN NETA.VRN1 TO CP NETA.WORKSTN1

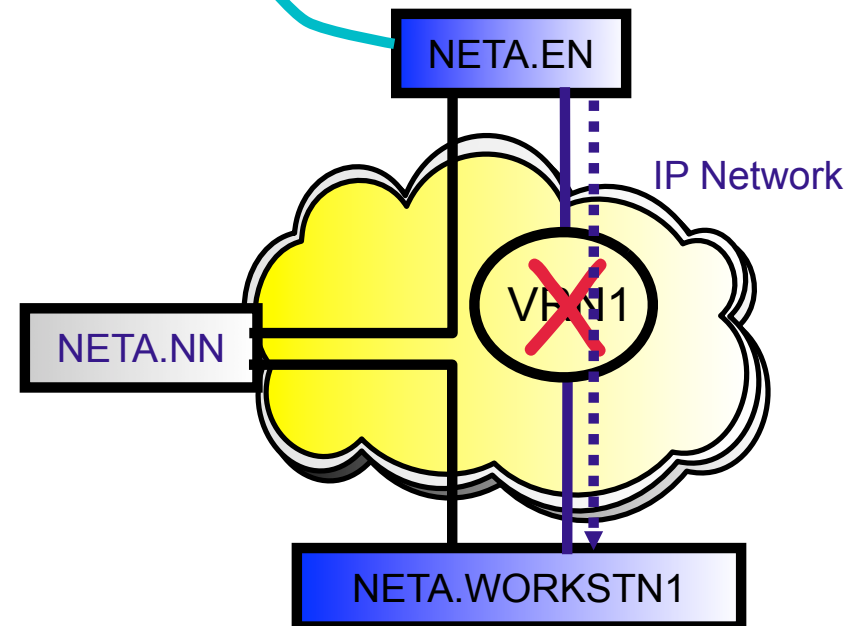

EE Connection Network Reachability Awareness

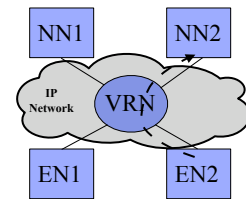

- 1 NN1 successfully contacts NN2 across VRN1.
- 2 NN1's attempt to contact NN3 across VRN1 fails.
- 3 In NN1's topology database, an "unreachability record" is associated with VRN1 for the partner NN3 (with a duration of 60 seconds) and a TDU is sent to partner NNs. The NN1->VRN1->NN3 route will not be used for the next 60 seconds.
- 4 With the unreachability record in place, a route is chosen from NN1 to NN3 by going through NN5 instead of VRN1.

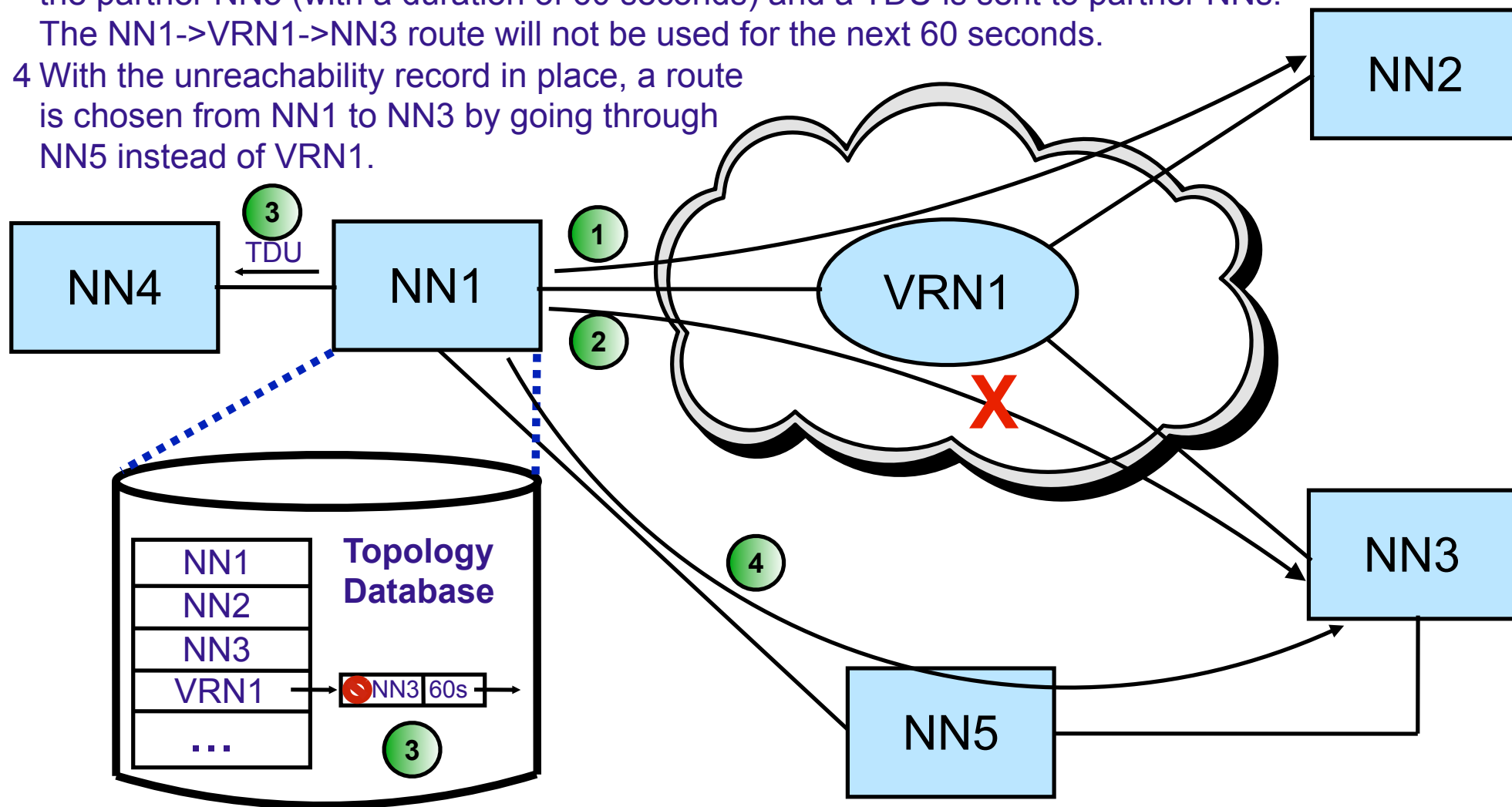

EE Connection Network Reachability Awareness

NOTES

- EE Connection Network Reachability Awareness detects a dial failure or connection INOP for a connection over an Enterprise Extender connection network and prevents that specific path to the partner node from being used for a period of time. If alternate paths are available, APPN Topology and Routing services will select the optimal alternate session path for session establishment or an HPR path switch.
- When the time expires, if the path through the EE virtual routing node (VRN) still has the lowest weight of any available path to the partner node, the path over this particular VRN will be selected on the next attempt to redial the partner node.
- Unreachable partner information is maintained in the Topology Database and is associated with an EE VRN or with an end node that is on the origin side of the VRN.
- Unreachable partner information is sent to an end node's NNS or broadcast to a network node's adjacent network nodes in Topology Database Updates (TDUs).
- The period of time that a path through the EE VRN to the unreachable partner will remain unavailable is configurable. The UNRCHTIM start option allows the specification of the default number of seconds that a partner node for a session path through an EE connection network is considered unreachable after connection network failures.
- During this UNRCHTIM period, the path through the EE VRN to this partner node will not be considered for new sessions or HPR path switches.
- UNRCHTIM can also be specified on the PORT and/or GROUP statements in the EE XCA major node. This provides the capability of specifying different unreachability durations for connection networks of different characteristics, or to different business partners, etc.
- The range for UNRCHTIM is 0, or 10-65535 seconds.
- UNRCHTIM=0 indicates that paths through EE connection networks will always be considered for routing. This is the default value.
- Current unreachability information can be displayed using the DISPLAY TOPO command.
- Unreachability records may be cleared using the MODIFY TOPO command.
- To prevent the performance impact of unreachability lists growing without bound, once a certain number of records is associated with a connection network, that VRN will be treated as quiesced. No further attempts will be made to use it (and no more records will be added) until the record count drops below a threshold.
- A second parameter specifiable with UNRCHTIM allows control of the number of records at which the VRN will be quiesced. The VRN will be considered usable again when the record count drops below 80% of that value. So, for example, UNRCHTIM=(60,20) would set the unreachable time to 60 seconds, with the record count allowed to grow until 20 before the VRN is quiesced. The quiesced status would be cleared when the record count dropped below 16 (80% of 20).
- If UNRCHTIM is enabled, the default value for the record limit is 10.

Preventing Unwanted Searches from EBN Partners

- Predefine Non-Native ADJCPs With ALIASRCH=NO

- Prevents ALIAS searches from entering your network through one or more adjacent CPs
 - Forces adjacent customers to ensure that searches entering your network are network-qualified
 - Default value of ALIASRCH=YES can still be used for "trusted" or "test" networks

- AUTHNETS=(NET1,NET2,...) On ADJCPs

- Only allow EBN partner to search for targets with Net IDs specified in the AUTHNETS list

```
*****
* Adjacent CP Major Node for NETA.A1
*****
*
ADJCPA1  VBUILD  TYPE=ADJCP
B1       ADJCP   NETID=NETB,ALIASRCH=NO,AUTHNETS=NETA
B2       ADJCP   NETID=NETB,ALIASRCH=NO,AUTHNETS=(NETA,NETC)
C1       ADJCP   NETID=NETC,ALIASRCH=YES
D1       ADJCP   NETID=NETD,ALIASRCH=NO,AUTHNETS=
```

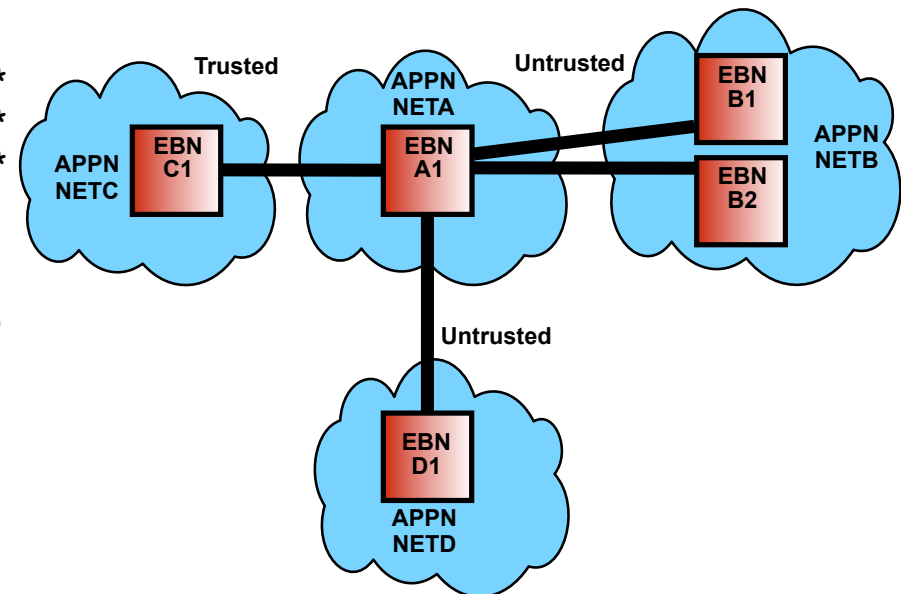

Diagnostic Tools

© Copyright International Business Machines Corporation 2012. All rights reserved.



EE Connectivity Test Command



- The Enterprise Extender connectivity test command is useful in debugging various network problems. This command can be used to test an existing Enterprise Extender connection, or it can be used to assist in diagnosing why an EE connection cannot be established.

- The EE connectivity test will verify:

- EE line availability

- Address resolution capability

- EE partner reachability

- The output generated from this request will show the reachability to the remote EE endpoint over all five UDP ports reserved for EE.

- When MULTIPATH function is enabled in the Enterprise Extender capable TCP/IP stack, the EE connectivity test is repeated for each valid TCP/IP interface which routes EE traffic.

```
D NET,EEDIAG,TEST=YES,LIST=DETAIL,ID=ETU2HO
...
IST2067I EEDIAG DISPLAY ISSUED ON 07/11/07 AT 10:41:12
IST1680I LOCAL IP ADDRESS 197.51.125.1
IST1680I REMOTE IP ADDRESS 197.51.153.1
...
IST924I -----
IST2133I INTFNAME: LMTU2BR55                INTFTYPE: MPCPTP
IST2134I CONNECTIVITY SUCCESSFUL                PORT: 12000
IST2137I 1 197.51.155.14                RTT: 1
IST2137I 2 197.51.153.1                RTT: 4
IST2134I CONNECTIVITY SUCCESSFUL                PORT: 12001
IST2137I 1 197.51.155.14                RTT: 2
IST2137I 2 197.51.153.1                RTT: 4
IST2134I CONNECTIVITY SUCCESSFUL                PORT: 12002
IST2137I 1 197.51.155.14                RTT: 2
IST2137I 2 197.51.153.1                RTT: 5
IST2134I CONNECTIVITY SUCCESSFUL                PORT: 12003
IST2137I 1 197.51.155.14                RTT: 2
IST2137I 2 197.51.153.1                RTT: 6
IST2134I CONNECTIVITY SUCCESSFUL                PORT: 12004
IST2137I 1 197.51.155.14                RTT: 3
IST2137I 2 197.51.153.1                RTT: 5
...

```

EE Connectivity Test Example



IPv4 EE connection is established from HostA to HostB, but HPR performance is poor

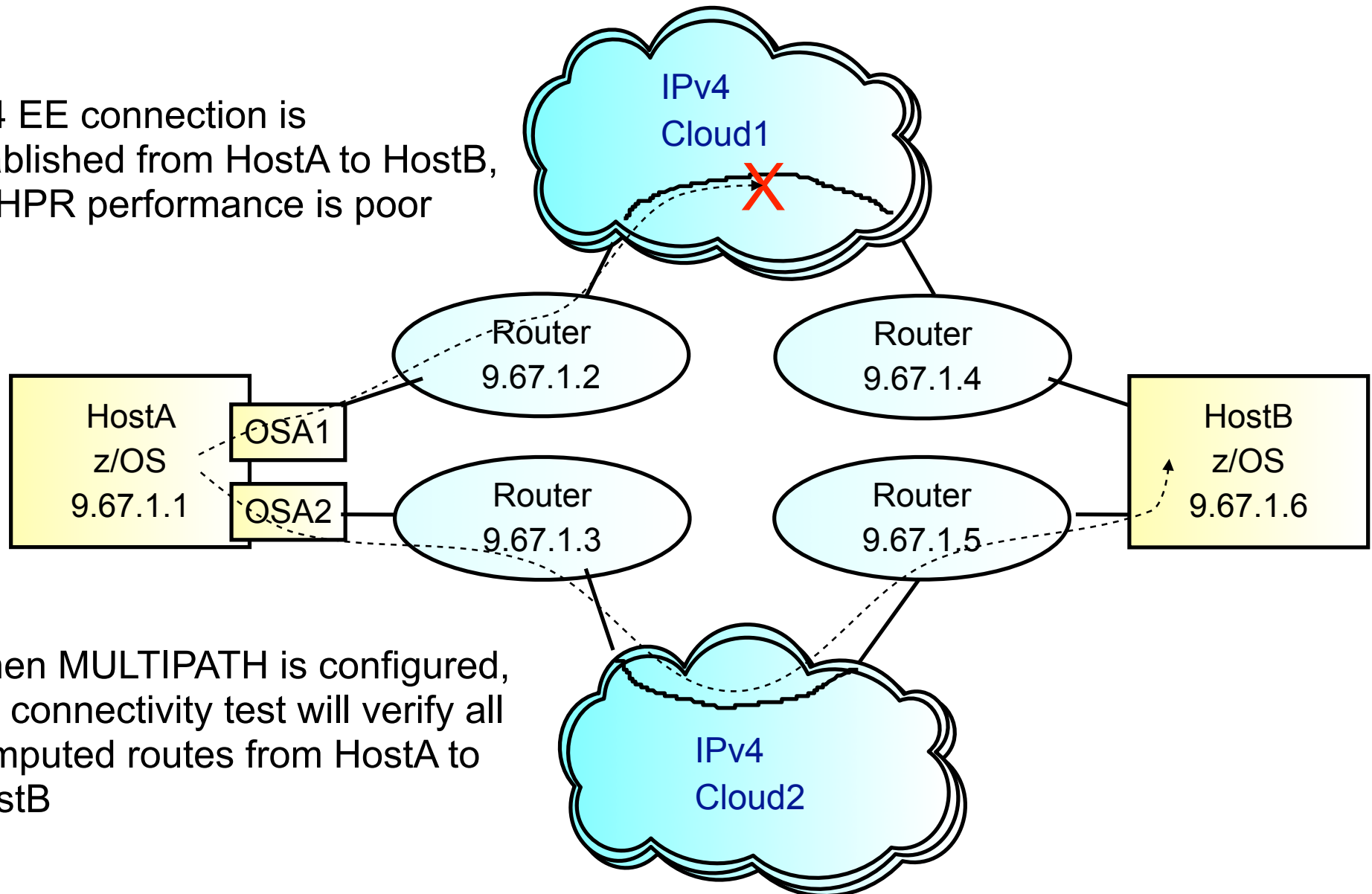

When MULTIPATH is configured, the connectivity test will verify all computed routes from HostA to HostB

EE Connectivity Test Example...



```
D NET,EEDIAG,TEST=YES,IPADDR=(9.67.1.1,9.67.1.6),LIST=DETAIL
```

```
IST097I DISPLAY ACCEPTED
IST350I DISPLAY TYPE = EEDIAG
IST2119I ENTERPRISE EXTENDER DISPLAY CORRELATOR: EE00000E
IST2067I EEDIAG DISPLAY ISSUED ON 10/04/05 AT 11:05:50
IST1680I LOCAL IP ADDRESS 9.67.1.1
IST1680I REMOTE IP ADDRESS 9.67.1.6
IST2023I CONNECTED TO LINE LN11
IST2126I CONNECTIVITY TEST IN PROGRESS
IST314I END
```

```
.
.
```

EE Connectivity Test Example...



```
IST350I DISPLAY TYPE = EEDIAG
IST2130I ENTERPRISE EXTENDER CONNECTIVITY TEST INFORMATION
IST2119I ENTERPRISE EXTENDER DISPLAY CORRELATOR: EE00000E
IST2131I EEDIAG DISPLAY COMPLETED ON 10/04/05 AT 11:05:52
IST2132I LDLC PROBE VERSIONS: VTAM = V1 PARTNER = V1
IST1680I LOCAL IP ADDRESS 9.67.1.1
IST1680I REMOTE IP ADDRESS 9.67.1.6
IST924I -----
IST2133I INTFNAME: OSA1          INTFTYPE: OSAFDDI
IST2135I   CONNECTIVITY UNSUCCESSFUL   SENSE: ***NA***   PORT: 12000
IST2137I     1 9.67.1.2                RTT:           2
IST2137I     2 9.67.1.21              D-1           RTT:           3
IST2135I   CONNECTIVITY UNSUCCESSFUL   SENSE: ***NA***   PORT: 12001
IST2137I     1 9.67.1.2                RTT:           2
IST2137I     2 9.67.1.21              D-1           RTT:           3
IST2135I   CONNECTIVITY UNSUCCESSFUL   SENSE: ***NA***   PORT: 12002
IST2137I     1 9.67.1.2                RTT:           2
IST2137I     2 9.67.1.21              D-1           RTT:           4
IST2135I   CONNECTIVITY UNSUCCESSFUL   SENSE: ***NA***   PORT: 12003
IST2137I     1 9.67.1.2                RTT:           2
IST2137I     2 9.67.1.21              D-1           RTT:           4
IST2135I   CONNECTIVITY UNSUCCESSFUL   SENSE: ***NA***   PORT: 12004
IST2137I     1 9.67.1.2                RTT:           2
IST2137I     2 9.67.1.21              D-1           RTT:           3
.
.
```

EE Connectivity Test Example...

NOTES

```
IST2137I  hop  ipv4address          flags  RTT:  time
```

This message displays information gathered during the EE connectivity test over an IPv4 route using the OSA1 adaptor. Take the following IST2137I message from the previous display:

```
IST2137I      2  9.67.1.21          D-1    RTT:    3
```

2 is the TTL *hop* count used in the LDLC probe command.

9.67.1.21 is the source IPv4 address (*ipv4addr*) from the ICMP response.

In this case, the *flags* field (D-1 in this example) has a format of *t-ccc*.

Where *t* is a representative character of the ICMP message type returned in response to the LDLC probe and *ccc* represents the specific code associated with the ICMP message type.

The ICMP message type is displayed as one of the following:

D - "Destination Unreachable"	ICMP Type 3
P - "Parameter Problem"	ICMP Type 12
Q - "Source Quench"	ICMP Type 4

Hop 2 returned an ICMP message type 3 with a specific code of 1 in response to the EE probe. Message IST2137I indicates this by displaying the *flags* field as D-1. For a list of the ICMP types and codes, see Appendix E in the z/OS Communications Server: IP System Administrator's Commands, "ICMP/ICMPv6 types and codes".

time is the round trip time for the LDLC probe to be sent to the TTL hop, and for an ICMP response to be received. In this example, the round trip time is 3 milliseconds.

EE Connectivity Test Example...



```
IST924I -----
IST2133I INTFNAME: OSA2                INTFTYPE: OSAFDDI
IST2134I   CONNECTIVITY SUCCESSFUL                PORT: 12000
IST2137I     1 9.67.1.3                RTT:      9
IST2137I     2 9.67.1.11               RTT:     14
IST2137I     3 9.67.1.12               RTT:     19
IST2137I     4 9.67.1.5                 RTT:     23
IST2137I     5 9.67.1.6                 RTT:     27
IST2134I   CONNECTIVITY SUCCESSFUL                PORT: 12001
IST2137I     1 9.67.1.3                RTT:      8
IST2137I     2 9.67.1.11               RTT:     14
IST2137I     3 9.67.1.12               RTT:     17
IST2137I     4 9.67.1.5                 RTT:     21
IST2137I     5 9.67.1.6                 RTT:     25
.
.
IST2134I   CONNECTIVITY SUCCESSFUL                PORT: 12004
IST2137I     1 9.67.1.3                RTT:      7
IST2137I     2 9.67.1.11               RTT:     11
IST2137I     3 9.67.1.12               RTT:     12
IST2137I     4 9.67.1.5                 RTT:     17
IST2137I     5 9.67.1.6                 RTT:     23
IST924I -----
IST2039I CONNECTIVITY TEST INFORMATION DISPLAYED FOR 2 INTERFACES
IST314I END
```

EE Connectivity Test Example...

NOTES

```
IST2137I  hop  ipv4address      flags  RTT:  time
```

This message displays information gathered during the EE connectivity test over an IPv4 route using the OSA2 adaptor. Take the following IST2137I message from the previous display:

```
IST2137I      5  9.67.1.6                RTT:      27
```

5 is the TTL *hop* count used in the LDLC probe command. In this case, the EE connectivity test was successful over each of the 5 EE ports. Each IST2137I message indicating it was a 5 hop route to reach the EE partner with an IPv4 address of 9.67.1.6.

In this case, the *flags* field is blank as there were not any probe retries or any unexpected ICMP messages returned.

time is the round trip time for the LDLC probe to be sent to the TTL hop, and for the LDLC probe response (UDP datagram) to be received from the EE partner. In this example, the round trip time is 27 milliseconds.

EE Connectivity Test Considerations

- EE connectivity test expects ICMP messages to be returned from intermediate hops
- Firewall configurations may have limited diagnostic output
 - Firewalls may be configured to block ICMP messages
 - Intermediate hops past firewall will appear as unresponsive, but final destination reachability can still be determined (see next foil) assuming destination has EE Test probe "responder" support.
 - Minimally configure firewall to allow ICMP "Time Exceeded"
 - IPv4: ICMP Message Type 11
 - IPv6: ICMPv6 Message Type 3
 - Firewalls may be configured to block UDP traffic
 - Firewalls must allow UDP traffic for EE UDP ports 12000-12004
 - Test probe response may route through firewall
 - Probe response is not an ICMP message. It is a UDP datagram.
- EE Test probe "responder" support
 - Support available for CS/Windows, CS/AIX, CS/Linux, PComm, & Cisco SNASw



EE Connectivity Test w/Firewalls Blocking ICMP

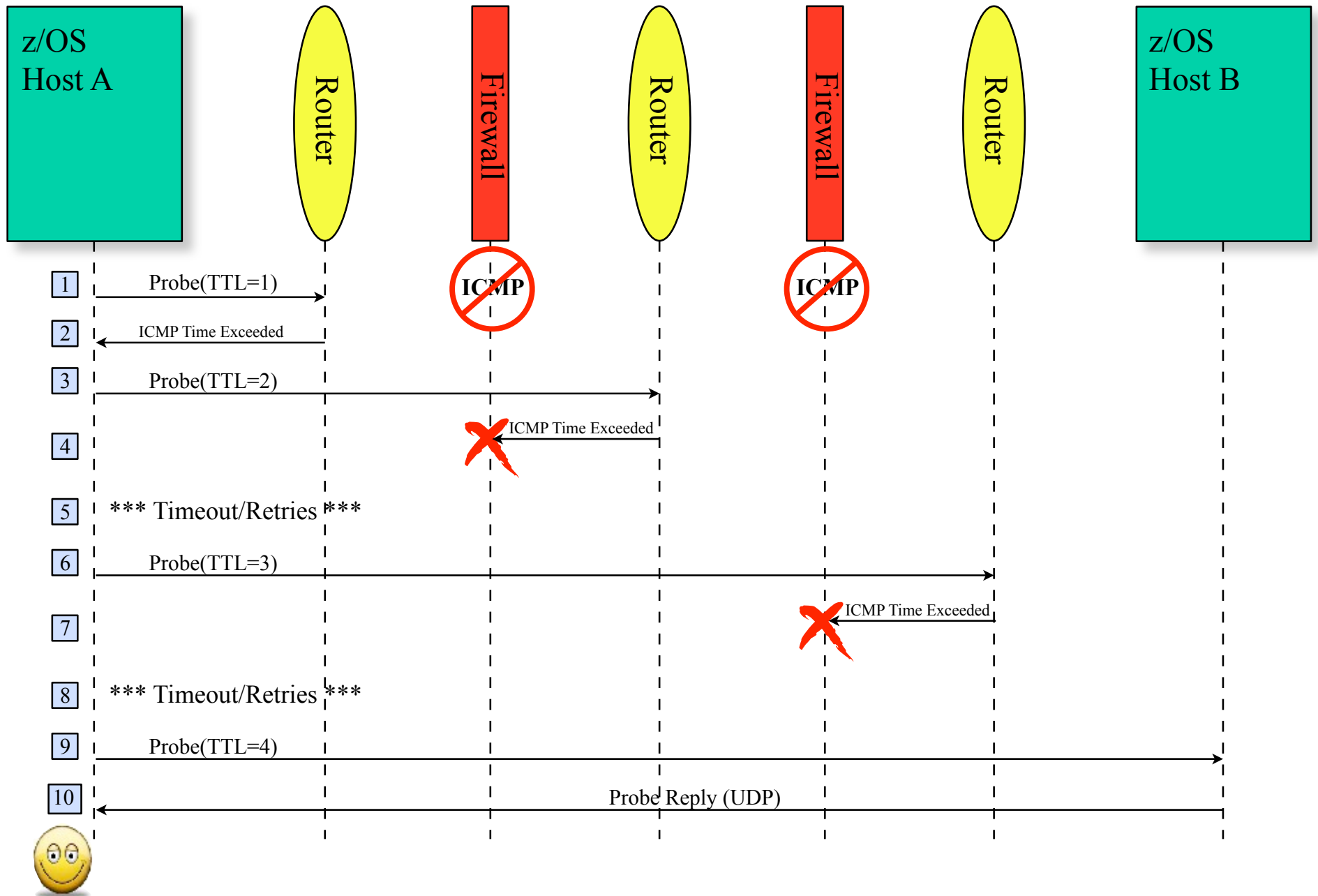

EE Connectivity Test w/Firewalls Blocking ICMP...

The previous chart illustrates what happens when Host A issues an EE connectivity test command with Host B as the partner, but there are intervening firewalls that do not allow the passage of ICMP messages.

- (1) Host A begins trying to verify partner reachability by sending an LDLC Probe command inside of a UDP packet. (The same UDP packet would be sent on all 5 EE ports.) For the first flow, the Time-To-Live (TTL) value is set to one.
- (2) When the UDP packet reaches the first router in the path, the router decrements the TTL value to zero. Since the TTL is zero, the packet is discarded, and an ICMP "Time Exceeded" message is returned.
- (3) Upon receiving the the ICMP response, Host A sends the probe again, but with the TTL value incremented to two.
- (4) When the probe reaches the second router on the path, that router decrements TTL to zero, and again the packet is discarded and an ICMP "Time Exceeded" response generated. However, in this case a firewall between that router and Host A is blocking ICMP, and discards the message.
- (5) After three seconds, Host A will timeout and resend the probe, still with a TTL of two. Again, the ICMP response will be discarded. After a second three-second timeout, Host A will retry one last time, and will again timeout after three more seconds.
- (6) After the three attempts to send the probe with a TTL of two (and three timeouts spanning a total of nine seconds), Host A will resend the probe with a TTL value of three.
- (7) When the probe reaches the third router on the path, that router decrements TTL to zero, and again the packet is discarded and an ICMP "Time Exceeded" response generated. Again a firewall between that router and Host A is blocking ICMP, and discards the message.
- (8) Once again, Host A goes through a sequence of three-second timeouts and probe retries.
- (9) After exhausting its retries with a TTL value of three, Host A sends the probe with a TTL value of four. In this case, the probe makes it all the way to Host B.
- (10) Host B does not respond with an ICMP message, but instead sends an LDLC Probe Response message as a UDP datagram. This packet makes it back to Host A, verifying that Host B is a reachable EE partner.

The MAXTIME operand on the EE connectivity test command is used to specify how long VTAM will spend performing the connectivity test before terminating the test, and displaying the available information. The default value of MAXTIME is 60 seconds.

Firewall-Friendly EE Connectivity Test (V1R13)

- V1R13 introduced a new “firewall-friendly” form of the EE Connectivity Test
 - The “DISPLAY EEDIAG,TEST=YES,LIST=SUMMARY” command will quickly verify partner reachability
 - The TTL is set to the maximum hop limit so that the partner can quickly receive the Probe command and generate a UDP Probe reply packet.
 - Intermediate hop analysis is not possible

```
D NET,EEDIAG,TEST=YES,IPADDR=(9.67.1.1,9.67.1.5),LIST=SUMMARY
IST097I DISPLAY ACCEPTED
IST350I DISPLAY TYPE = EEDIAG
IST2119I ENTERPRISE EXTENDER DISPLAY CORRELATOR: EE000001
IST2067I EEDIAG DISPLAY ISSUED ON 08/29/05 AT 15:41:22
*****
IST1680I LOCAL IP ADDRESS 9.67.1.1
IST1680I REMOTE IP ADDRESS 9.67.1.5
IST924I -----
IST2133I INTFNAME: LTRLE1A                INTFTYPE: MPCPTP
IST2134I   CONNECTIVITY SUCCESSFUL                PORT: 12000
IST2137I   *NA 9.67.1.5                RTT:      6
...
IST2134I   CONNECTIVITY SUCCESSFUL                PORT: 12004
IST2137I   *NA 9.67.1.5                RTT:      7
IST924I -----
IST2139I CONNECTIVITY TEST RESULTS DISPLAYED FOR 1 OF 1 ROUTES
IST314I END
```

Path MTU Discovery for EE

- Path MTU Discovery (PMTU) for EE:
 - IPv4: Stacks set "don't fragment" (DF) bit in all outbound IPv4 EE packets
 - IPv6 does not support fragmentation in the network
 - Stack monitors for ICMP/ICMPv6 "Packet too big" messages
 - Stack updates VTAM with learned path MTU
 - Local RTP pipes segment to new size
- PMTU originally architected as TCP-based solution and did not apply to UDP
 - PMTU for EE is an EE-specific adaptation of PMTU, and does not apply to UDP in general

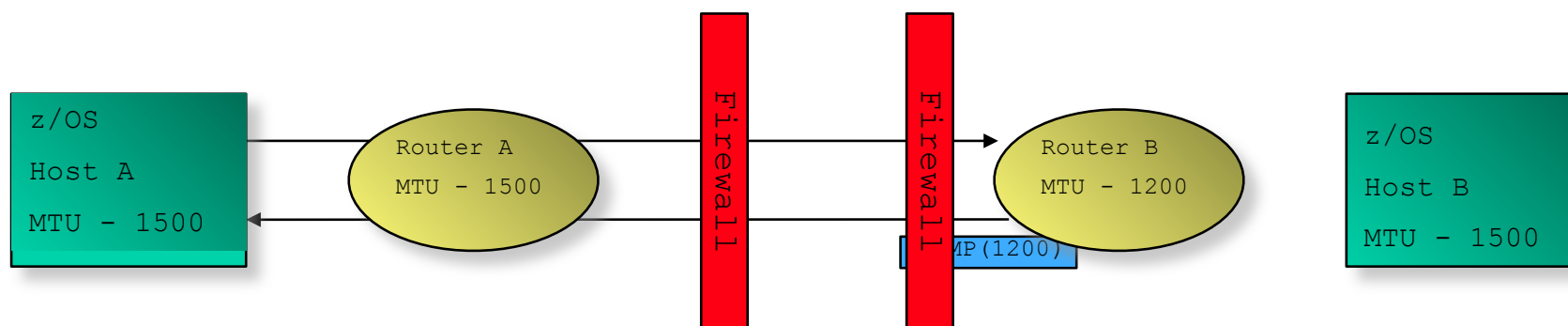

Path MTU Discovery for EE...

- Path MTU Discovery requires ICMP messages to be returned
 - Some firewalls are configured to block ICMP
 - Minimally configure firewalls to permit the following ICMP messages for ports 12000-12004:
 - IPv4: ICMP Message Type 3 - Destination Unreachable
 - IPv6: ICMPv6 Message Type 2 - Packet Too Big
 - Do NOT enable PMTU if ICMP messages are not permitted through the firewalls

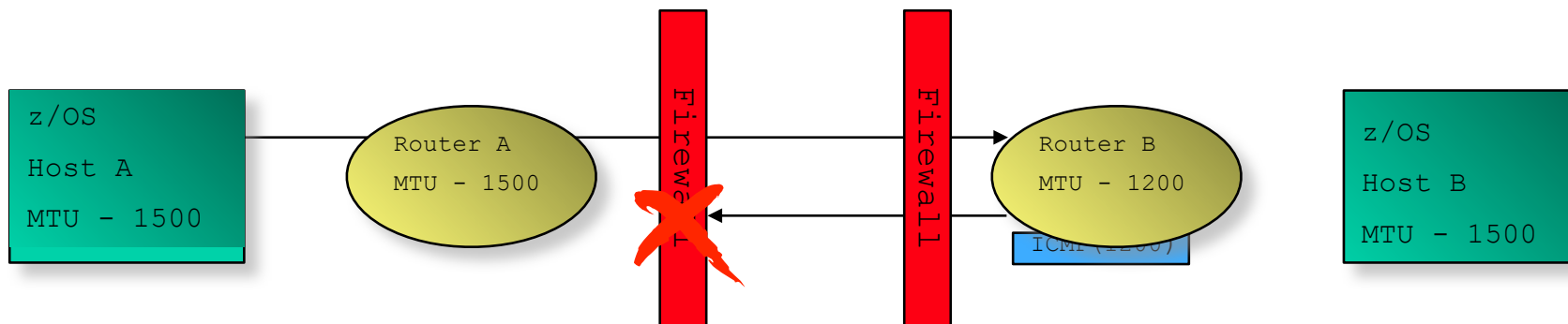

- For situations where enabling PMTU for EE is not viable, or is not an adequate solution, the MTU operand allows static configuration of the MTU size to be used for the EE connection:
 - MTU = *mtu_size*
 - Specifiable on EE switched PU, EE XCA GROUP (connection network), and EE model PU

HPR Path Switch Summarization

- HPR Path Switch Summarization reduces the number of path switch message groups VTAM issues across a 60-second interval
- HPRPSMSG=ALL|count, where count is in the range 10-100
- The HPRPSMSG value specifies the number of IST1494I ("Path Switch Started") messages that will be issued, before suppressing the remaining ones across the 60-second interval.
 - If the STARTED message is issued for a pipe, the associated COMPLETED or FAILED message will always be issued as well
- At the end of the 60-second interval, a summarization report is issued on total path switch activity during the interval
 - The report output is limited to 10 Net IDs and 50 CPs, but the "started", "completed", and "failed" counts will accurately reflect all path switch activity
- If HPRPSMSG=ALL is specified, then all path switch message groups will be issued and no summarization provided
- If you have previously specified IST1494I in the message flooding prevention table, you will probably want to remove it when enabling path switch summarization

HPR Path Switch Summarization...

```

IST2191I HPR PATH SWITCH SUMMARY FROM 04/05/06 AT 09:45:14
IST924I -----
IST2192I STARTED      =      12
IST2193I   TGINOP    =      12   SRQTIMER =      0   PSRETRY   =      0
IST2194I   PARTNER   =      0   MNPS     =      0   UNAVAILABLE =      0
IST2195I   NETWORK   =      3   HIGH    =      3   MEDIUM   =      3   LOW     =      3
IST924I -----
IST2196I COMPLETED  =      8
IST2195I   NETWORK   =      2   HIGH    =      2   MEDIUM   =      2   LOW     =      2
IST924I -----
IST2197I FAILED      =      4
IST2195I   NETWORK   =      1   HIGH    =      1   MEDIUM   =      1   LOW     =      1
IST924I -----
IST2198I NETID          STARTED          COMPLETED          FAILED
IST2199I   CPNAME      NET  HI MED LOW  NET  HI MED LOW  NET  HI MED LOW
IST2205I -----
IST2200I NETA          2   2   2   2    1   1   1   1    1   1   1   1
IST2201I   SSCP2A      1   1   1   1    1   1   1   1    0   0   0   0
IST2201I   SSCP7A      1   1   1   1    0   0   0   0    1   1   1   1
IST2205I -----
IST2200I NETB          1   1   1   1    1   1   1   1    0   0   0   0
IST2201I   SSCP99      1   1   1   1    1   1   1   1    0   0   0   0
IST924I -----
IST2206I 24 PATH SWITCH EVENTS FOR 3 CPS IN 2 NETIDS
IST314I END

```

Progressive Mode ARB

- HPR's Responsive Mode ARB flow control is very sensitive to minor variations in packet round-trip time or unpredictability in response time from the RTP partner node. If the partner suddenly becomes CPU constrained, even for a short period, throughput and response time can be degraded.

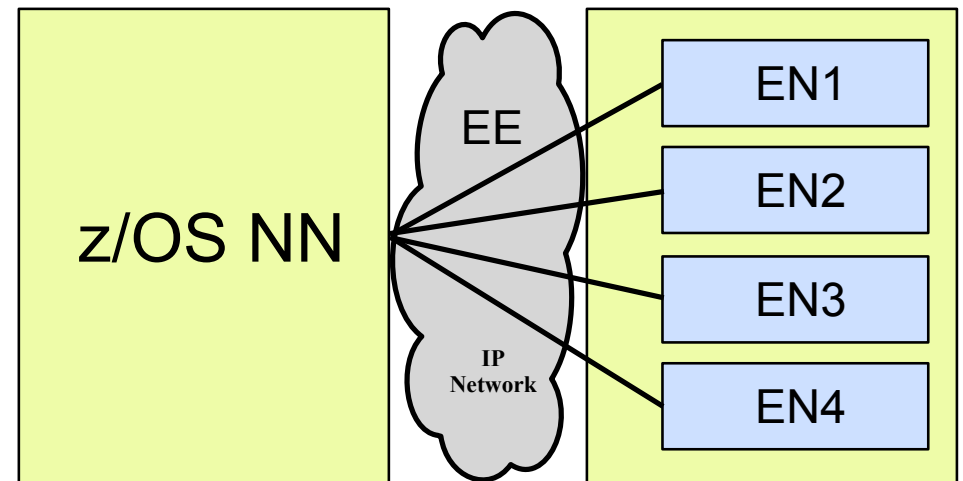

- Typical causes:

- Partner node has a shortage of CPU availability, memory, or network bandwidth
- Partners in a virtual server environment on a single hardware platform cannot guarantee consistent response time

- V1R11 introduced a new level of the ARB flow control algorithm: Progressive Mode ARB

- Implements several small changes to the flow control rules to improve responsiveness in a CPU-constrained environment
- Both partners must agree to use progressive mode ARB
- Limited to single-hop pipes over an EE connection (including two-virtual-hop connection network paths)

APAR OA26490 is strongly recommended for V1R8, V1R9, and V1R10 for compatibility

Progressive Mode ARB ...

- HPREEARB = PROGRESS can be specified:
 - On an EE PU in a switched major node
 - On a connection network GROUP in the EE XCA major node
 - On the EE model PU in a model major node
- The desire/capability to use progressive mode ARB is conveyed between the RTP partners on the XID, route setup reply, and the RTP ARB setup segment. If both partners do not agree to use progressive mode ARB, responsive mode ARB will be used as the flow control protocol.
- A display of the RTP pipe will show that progressive mode ARB is being used:

```
D NET, ID=CNR00004
IST097I DISPLAY ACCEPTED
IST075I NAME = CNR00004, TYPE = PU_T2.1
.
.
IST2267I RTP PACING ALGORITHM = ARB PROGRESSIVE MODE
.
.
```

- Progressive Mode ARB is also available in Distributed CS V6.4.0 (for Windows, AIX, and Linux (both Intel and System z))
 - The architectural definition of progressive mode ARB is available for other platforms and vendors to implement

HPR Path Switch Delay



- If the RTP endpoint suspects a problem with partner communications, it will make several attempts to contact the partner, with a delay between attempts based on a “short request” (SRQ) timer value based on the round-trip time.
- At times this logic is too sensitive:
 - Transient network or partner conditions can cause temporary swings in round-trip time that can cause unnecessary entry into path switch state
 - In this case, the pipe usually path switches right back onto the same route
 - This wastes cycles and clutters the console with path switch messages
- V1R11 introduces new controls to specify a minimum time period that will be required before entering path switch state
 - Specifies the minimum amount of time a z/OS CS RTP endpoint must wait before initiating a path switch attempt due to an unresponsive partner
 - Does not control path switches initiated due to the PSRETRY function, the MODIFY RTP command, or local TG inops
 - This only affects the path switch logic on the local end of the RTP pipe. The path switch delay value is not negotiated with the RTP partner

A red circle with a diagonal slash through it, indicating a prohibition or warning.

```
...  
IST1818 PATH SWITCH REASON: SHORT REQUEST RETRY LIMIT EXHAUSTED  
...
```

HPR Path Switch Delay...



- New start option: `HPRPSDLY = 0 | ps-delay`
 - Specifying a non-zero value for this start option sets the minimum path switch delay value
 - Range: 0 - 240 seconds
 - Default value of zero indicates that the RTP pipe should enter path switch as soon as a predetermined number of retry attempts have been unsuccessful (prior behavior)
 - Can be modified via `MODIFY VTAMOPTS`
- `HPRPSDLY = value-of-HPRPSDLY-start-option | ps-delay | EEDELAY` can also be specified:
 - On an EE PU in a switched major node
 - On a connection network GROUP in the EE XCA major node
 - On the EE model PU in a model major node
 - If you set `HPRPSDLY` to `EEDELAY`, VTAM will calculate a delay value long enough to allow the EE LDLC mechanism to inop the EE connection in the event the EE partner becomes unreachable
 - Local EE inop will trigger path switch processing

```
D NET, ID=CNR00004, HPRDIAG=YES
IST097I DISPLAY ACCEPTED
IST075I NAME = CNR00004, TYPE = PU_T2.1
.
.
IST924I -----
IST1984I PATH SWITCH INFORMATION:
IST2271I PATH SWITCH DELAY = 90
IST2272I PATH SWITCH DELAYED UNTIL 11/17/08 AT 12:07:34
.
```

EE Health Verification (V1R12)



- The EE Health Verification function will verify the health of a potential EE connection by sending a probe to the remote partner using all five ports during the connection activation
 - VTAM does not activate the EE connection if the remote partner is not reachable on all ports
 - However, if the remote partner does not support the probe, VTAM will still bring up the EE connection
- EE Health Verification will also optionally verify the health of an active EE connection by sending a probe to the remote partner on all five ports at a user-specified interval
 - VTAM issues a warning message if the remote partner is not reachable on all ports, but will keep the connection active
- EE Health Verification is enabled by the EEVERIFY start option:
- Or the EEVERIFY GROUP/PU parameter:

```
____ EEVERIFY= _ ACTIVATE _____  
>> | _____ | _____ <<  
| _ EEVERIFY= _____ NEVER _____ |  
| _____ ACTIVATE _____ |  
| _____ time_interval_value _____ |
```

```
>> _____ <<  
| _ EEVERIFY= _____ NEVER _____ |  
| _____ ACTIVATE _____ |  
| _____ time_interval_value _____ |
```

- The time_interval_value can range from 1-1440 minutes

EE Health Verification...



- When EE Health verification fails for an active EE connection, VTAM issues highlighted warning message IST2323E if it is not already present:

IST2323E EE HEALTH VERIFICATION FAILED ON ONE OR MORE CONNECTIONS

- This message stays on the console until the condition is cleared or the message is erased by the operator
- DISPLAY EE,LIST=VERIFY is used to determine which connection(s) have failed verification:

```
d net,ee,list=eeverify
IST097I DISPLAY ACCEPTED
IST350I DISPLAY TYPE = EE
IST2000I ENTERPRISE EXTENDER GENERAL INFORMATION
IST1685I TCP/IP JOB NAME = TCPCS
IST2003I ENTERPRISE EXTENDER XCA MAJOR NODE NAME = XCAIP
...
IST924I -----
IST2324I EE HEALTH VERIFICATION: FAILED CONNECTION INFORMATION
IST2325I LINE LNIP1 PU SWIP2A1 ON 12/21/09 AT 15:56:39
IST2326I EE HEALTH VERIFICATION TOTAL CONNECTION FAILURES = 1
IST2017I TOTAL RTP PIPES =          1          LU-LU SESSIONS =          2
IST2018I TOTAL ACTIVE PREDEFINED EE CONNECTIONS =          1
IST2019I TOTAL ACTIVE LOCAL VRN EE CONNECTIONS =          0
IST2020I TOTAL ACTIVE GLOBAL VRN EE CONNECTIONS =          0
IST2021I TOTAL ACTIVE EE CONNECTIONS =          1
IST314I END
```

EE Health Verification...





- Using DISPLAY EE to display an individual EE connection will also provide information on the success or failure of EE Health Verification:

```
d net,ee,id=SWIP2A1
IST097I DISPLAY ACCEPTED
IST350I DISPLAY TYPE = EE
IST2001I ENTERPRISE EXTENDER CONNECTION INFORMATION
IST075I NAME = SWIP2A1, TYPE = PU_T2.1
IST1680I LOCAL IP ADDRESS 9.67.1.1
IST1680I REMOTE IP ADDRESS 9.67.1.2
IST2022I EE CONNECTION ACTIVATED ON 12/21/09 AT 16:21:57
IST2114I LIVTIME:      INITIAL =   10   MAXIMUM =   0   CURRENT =   10
IST2023I CONNECTED TO LINE LNIP1
IST2327I EE HEALTH VERIFICATION OPTION - EEVERIFY = 2 MINUTES
IST2329I EE HEALTH VERIFICATION SUCCESSFUL ON 12/21/09 AT 16:37:21
IST2341I EE HEALTH VERIFICATION HAS NEVER FAILED FOR THIS CONNECTION
IST2025I LDLC SIGNALS RETRANSMITTED AT LEAST ONE TIME      =      0
IST2026I LDLC SIGNALS RETRANSMITTED SRQRETRY TIMES        =      0
...
IST314I END
```

- If a connection is failing EE Health Verification, the DISPLAY EEDIAG,TEST=YES command can be used to further diagnose the cause of the failure.
- OA36193 is recommended maintenance (to improve coexistence with downlevel partners).

For More Information....



URL		Content
http://www.twitter.com/IBM_Commserver		IBM Communications Server Twitter Feed
http://www.facebook.com/IBMCommserver		IBM Communications Server Facebook Fan Page
https://www.ibm.com/developerworks/mydeveloperworks/blogs/IBMCommserver/?lang=en		IBM z/OS Communications Server Blog
http://www.ibm.com/systems/z/		IBM System z
http://www.ibm.com/systems/z/hardware/networking/		IBM System z Networking
http://www.ibm.com/software/network/commserver/zos/		IBM z/OS Communications Server
http://www.ibm.com/systems/z/os/zos/bkserv/		IBM z/OS Internet library – PDF files of all z/OS manuals including Communications Server
http://www.redbooks.ibm.com		IBM Redbooks
http://www.ibm.com/software/network/commserver/support		IBM Communications Server Technical Support
http://www.ibm.com/support/techdocs/		Technical Support Documentation (techdocs, flashes, presentations, white papers, etc.)
http://www.rfc-editor.org/rfcsearch.html		Request For Comments (RFCs)
http://publib.boulder.ibm.com/infocenter/ieduasst/stgv1r0/index.jsp		IBM Education Assistant

- Recommended White Paper:
 - “Securing an SNA Environment for the 21st Century” - <http://www-01.ibm.com/support/docview.wss?rs=852&uid=swg27013237>
- Recommended Redbooks:
 - SG24-7359-00 Enterprise Extender Implementation Guide
 - SG24-7334-00 A Structured Approach to Modernizing the SNA Environment
 - SG24-5957-00 Migrating Subarea to an IP Infrastructure