



Using Enterprise Extender in the Network with Cisco SNA Switch

Junnie Sadler & Kevin Manweiler
Cisco Systems, Inc.

jrsadler@cisco.com, kmanweil@cisco.com

Tuesday, March 1, 2011
Session 8203

Agenda

- Concepts
- Design Considerations
- Configuration
- Troubleshooting Tools

What Is Your Network Like?

- **OLD Technology:**
 - SA (sub area) -> APPN -> HPR -> EE
 - Token Ring -> Ethernet
 - DLSW+
 - FEP migration (esp. SNI)
- **New Technology**
 - OSA Express
 - SNASw
 - Connection network, global connection network
 - IPv6

SNA-to-IP Migration Solutions



SHARE

Technology • Connections • Results

In
the
Begining

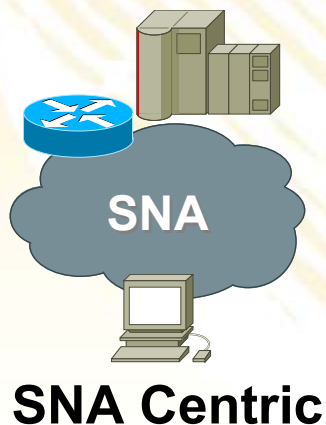

IP Client:
TN3270

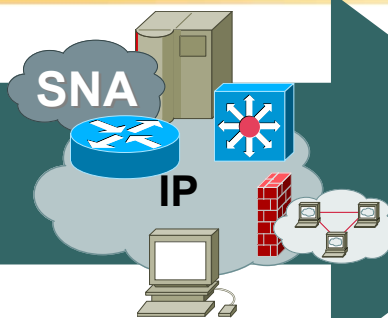

IP Integration:
SNASw

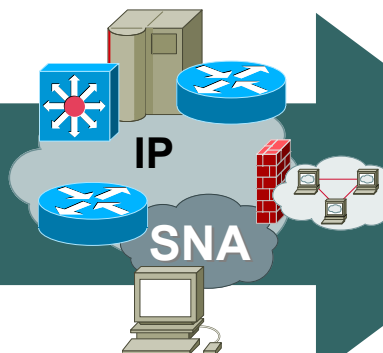

IP Transport:
DLSw+

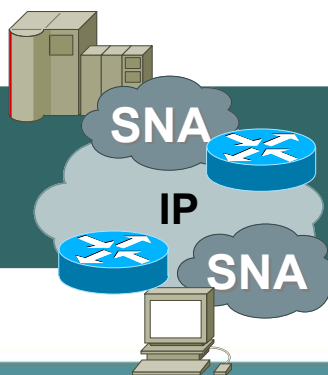

Ultimate
Goal

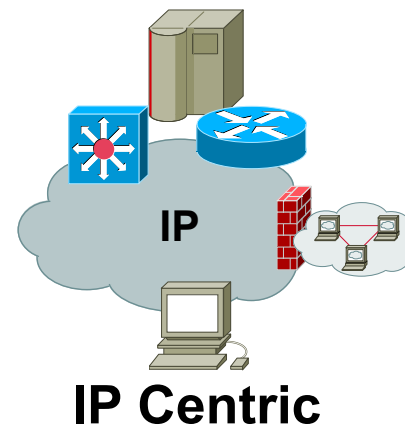

What is: SNA Switching Services (SNASw) ???

- Cisco's 2nd generation APPN feature, Cisco IOS 12.1 and above
- Simplified configuration and enhanced problem determination
- Dependent LU Requestor (DLUR) for peripheral SNA PU 2.0 devices
- Branch Extender (Bx or BEX) a.k.a. Branch Network Node (BrNN) for independent LUs (APPN scalability)
- Enterprise Extender (EE) supports HPR over IP (UDP transport)
- Global connection network (a.k.a. GVRN), EE hostname, IPv6, LDLC probe, etc.

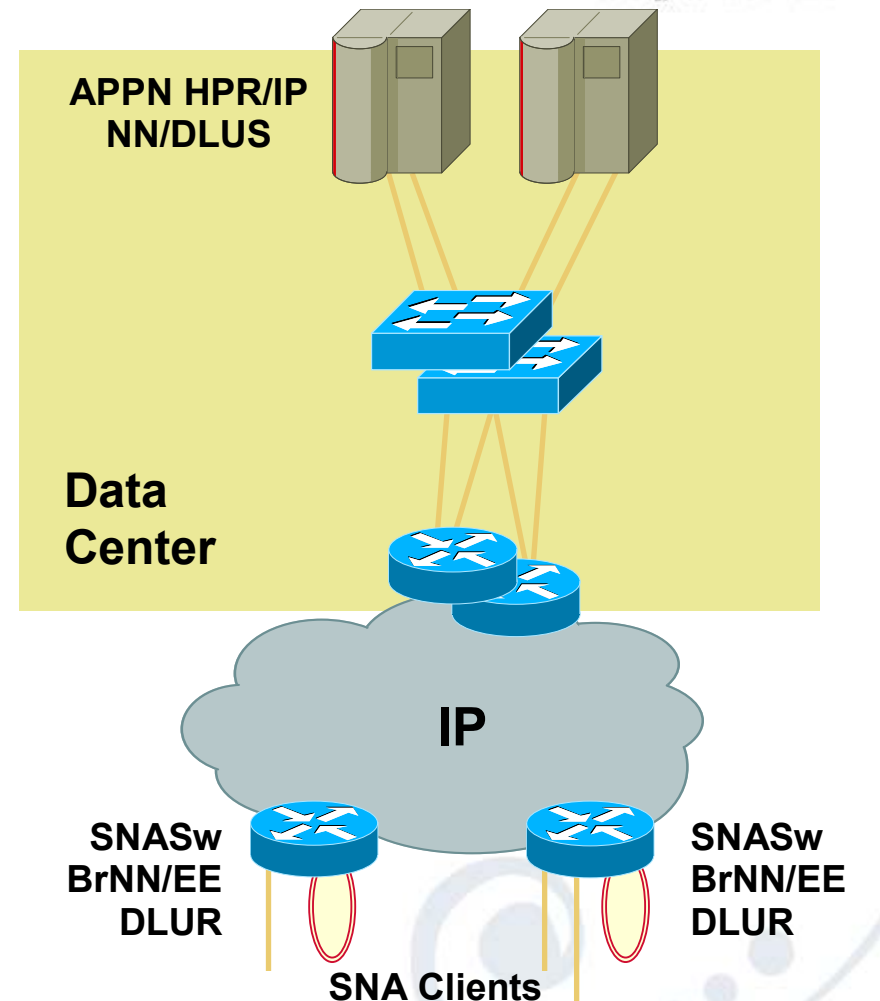

Dependent LU Requestor (DLUR)

- Requires APPN network
- Facilitates FEP replacement
 - SNASw provides session routing and boundary function in concert with Dependent LU Server (DLUS)
- XID indicates ACTPU support
- LU 6.2 CPSVRMGR “pipe” between DLUR/S
- SSCP-PU/LU RUs (i.e. ACTPU/LU) encapsulated
GDS 1500, PCID uniquely identifies traffic for each PU and its attached LUs

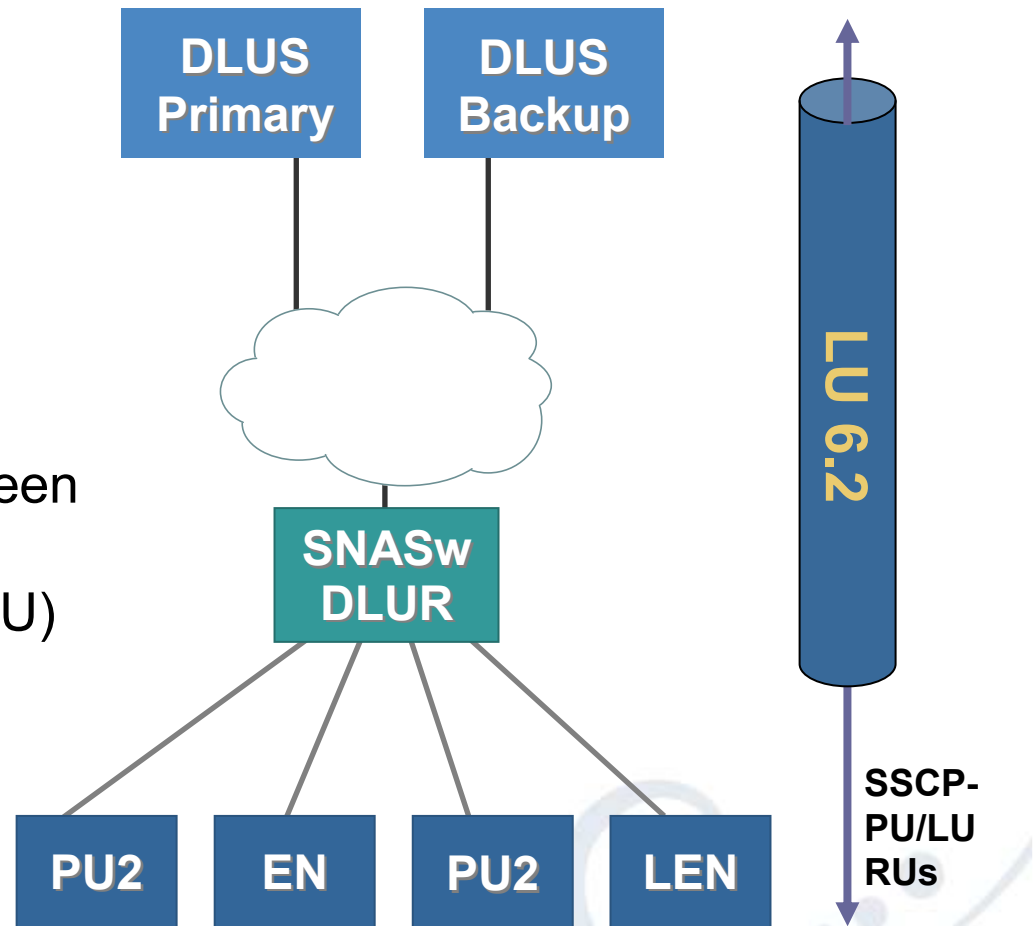

Dependent LU Session Setup

- LU definitions on DLUS (in Switched Major Node) activated with PU activation
- Topology Database Updates sent by DLUR to DLUS so DLUS has potential route information 'in pocket'
- LU requests session (i.e. INIT-SELF or USSLOGON) or APPL initiates session
- **DLUS engaged in search for session partners, but no locate flows to DLUR (except for special Border Node case)**
- **DLUS engaged in search for session partners, but no locate flows to DLUR (except for special Border Node case)**

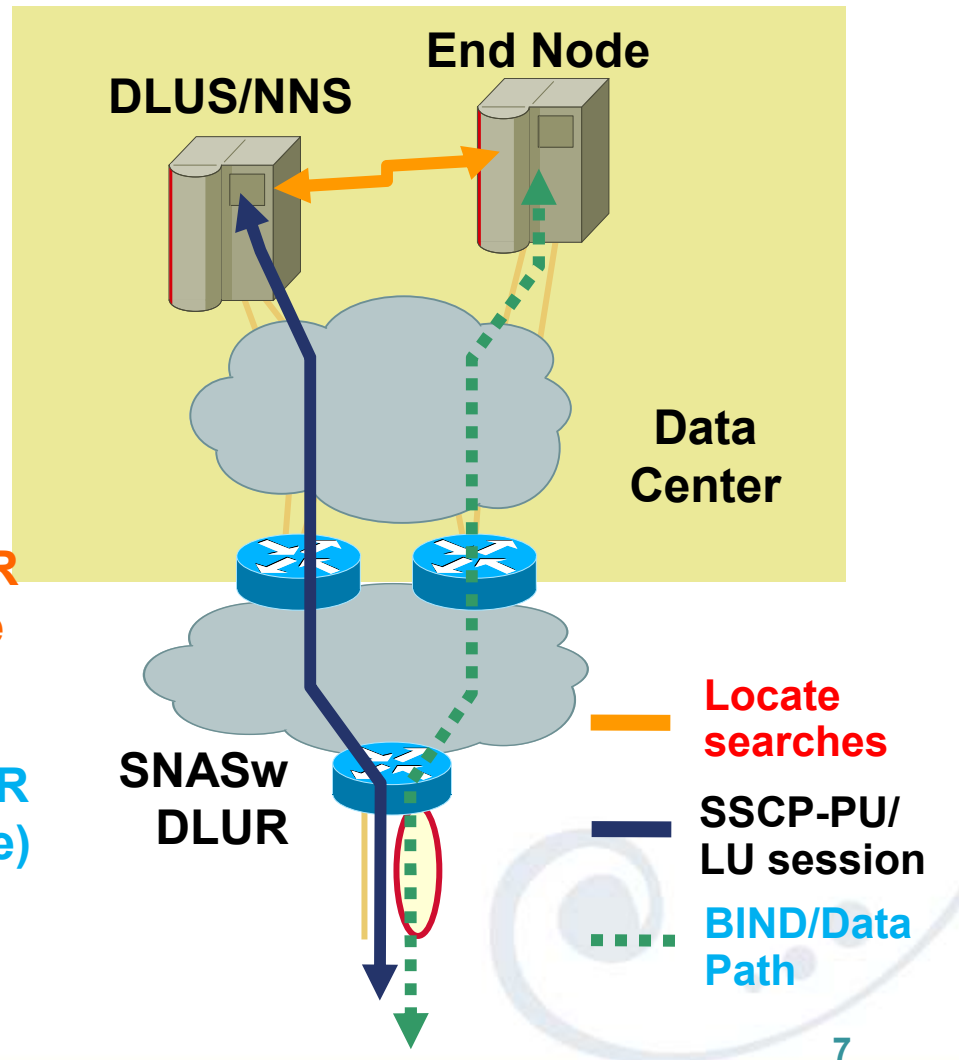

What Is a Branch Extender (BrNN)?

- Architected APPN hybrid node type
- BrNN looks like a NN to downstream devices
- BrNN looks like an EN to upstream VTAM NNs
- NN to NN Broadcast traffic does not go to/from BrNN
- Topology exchanges are between VTAM NNs only, not BrNNs
- VTAM is shielded from downstream ENs and LENS
- Result is better network scalability

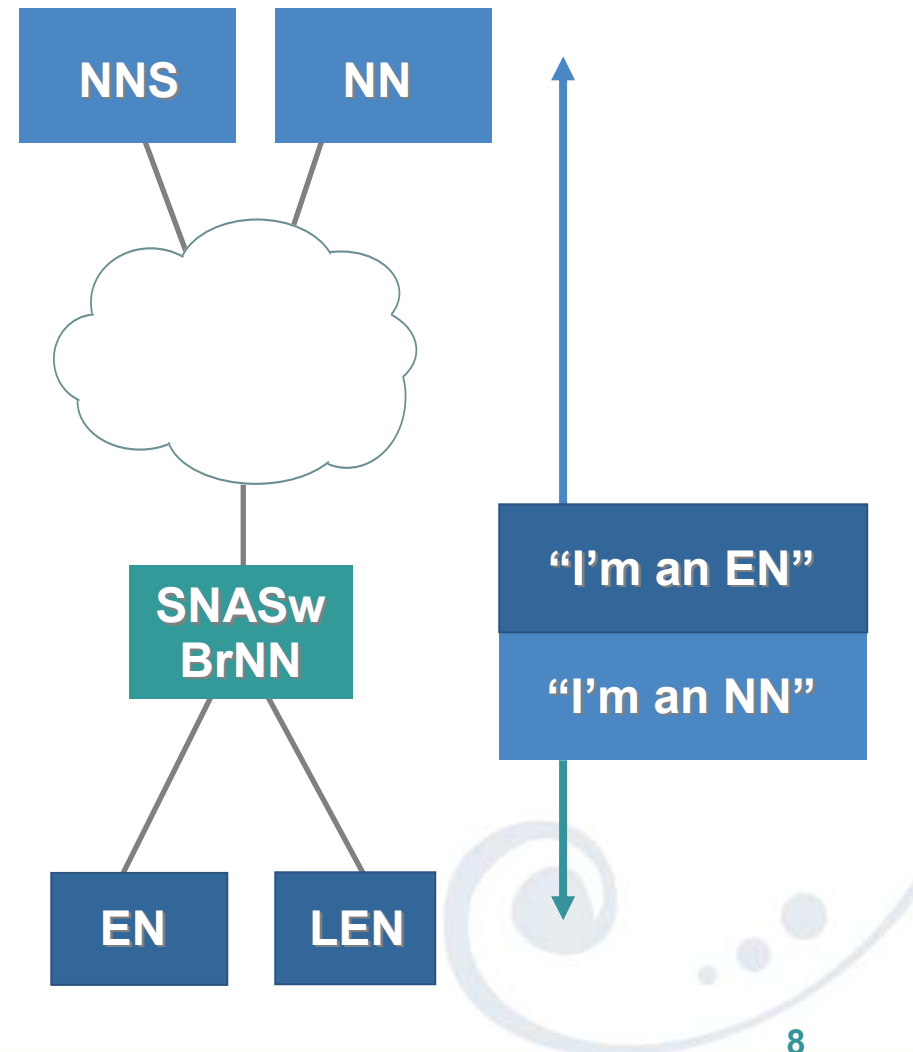

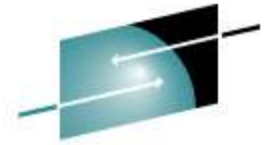

BrNN Connectivity

Upstream (uplink) —

- BrNN requires a Network Node Server and Dependent LU Server (can be same)
- Backup NNS/DLUS recommended

Peer (neutral link) —

- Use connection network to connect BrNN peers (and in place of defined uplinks, i.e. to upstream ENs)

Downstream (downlink) —

- No NNs (unless disguised as LEN)
- BrNN allowed only if not using DLUR (Independent LU sessions only)

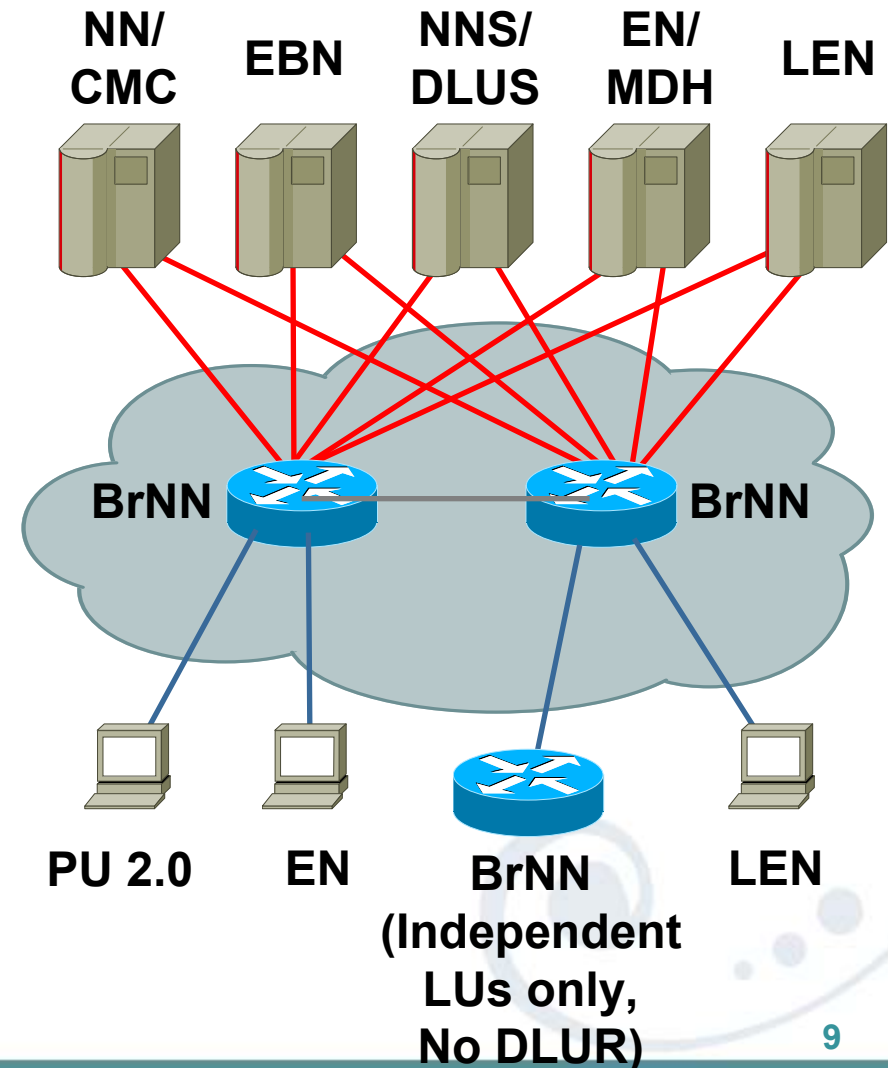

Independent LU Session Setup

- BrNN(EN) registers ILUs to NNS/VTAM
 - EN resources registered automatically
 - LEN nodes may require configuration (snasw location) to register
- BrNN includes 'tail vectors' on Locate find (Primary LU downstream) or locate found (Primary LU upstream) for NNS to use in route calculation cost
- Route calculated by NNS based on APPN COS
- BIND must pass through BrNN
- Traffic routed from BrNN directly to/from correct application host

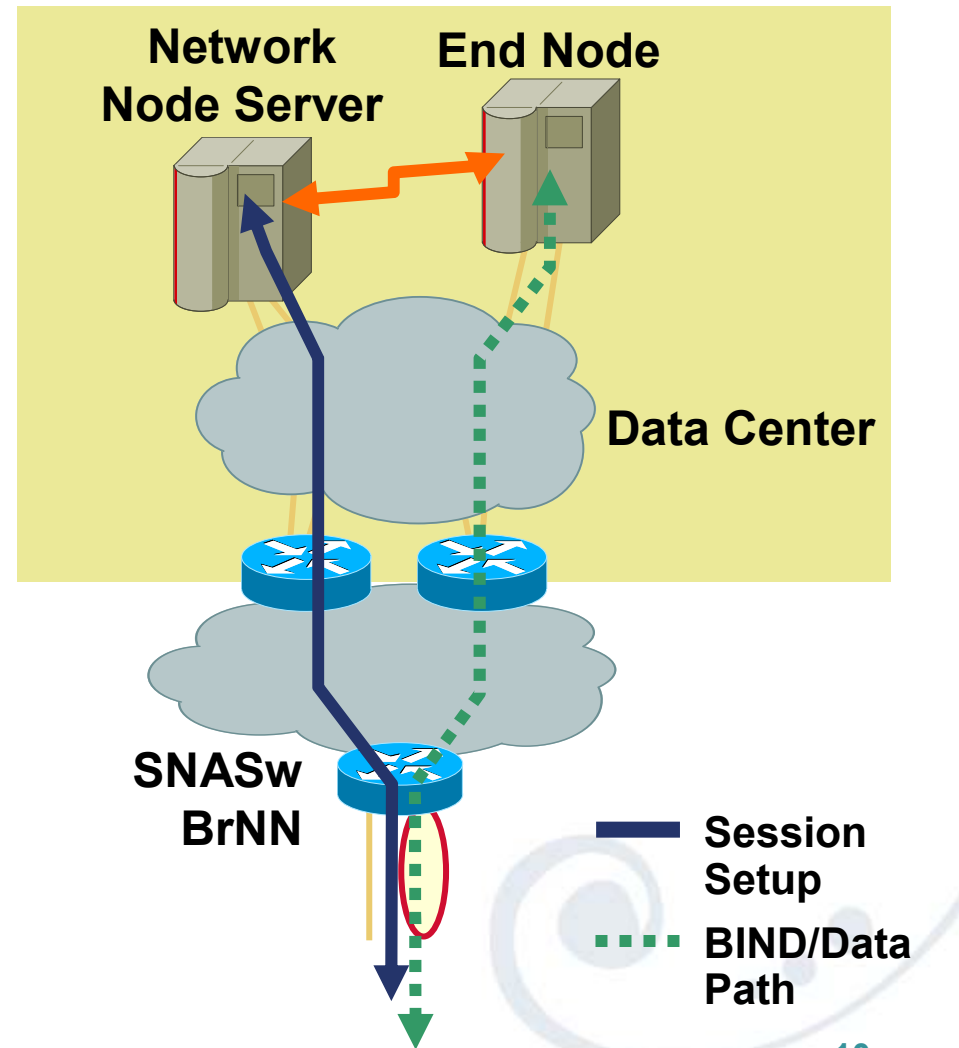

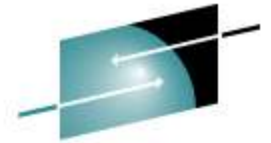

SNASw EE Pipes

- Multiple connections between the SNASw router and NNS
- Separate RTP pipes over to the application EN's and one for each CoS.

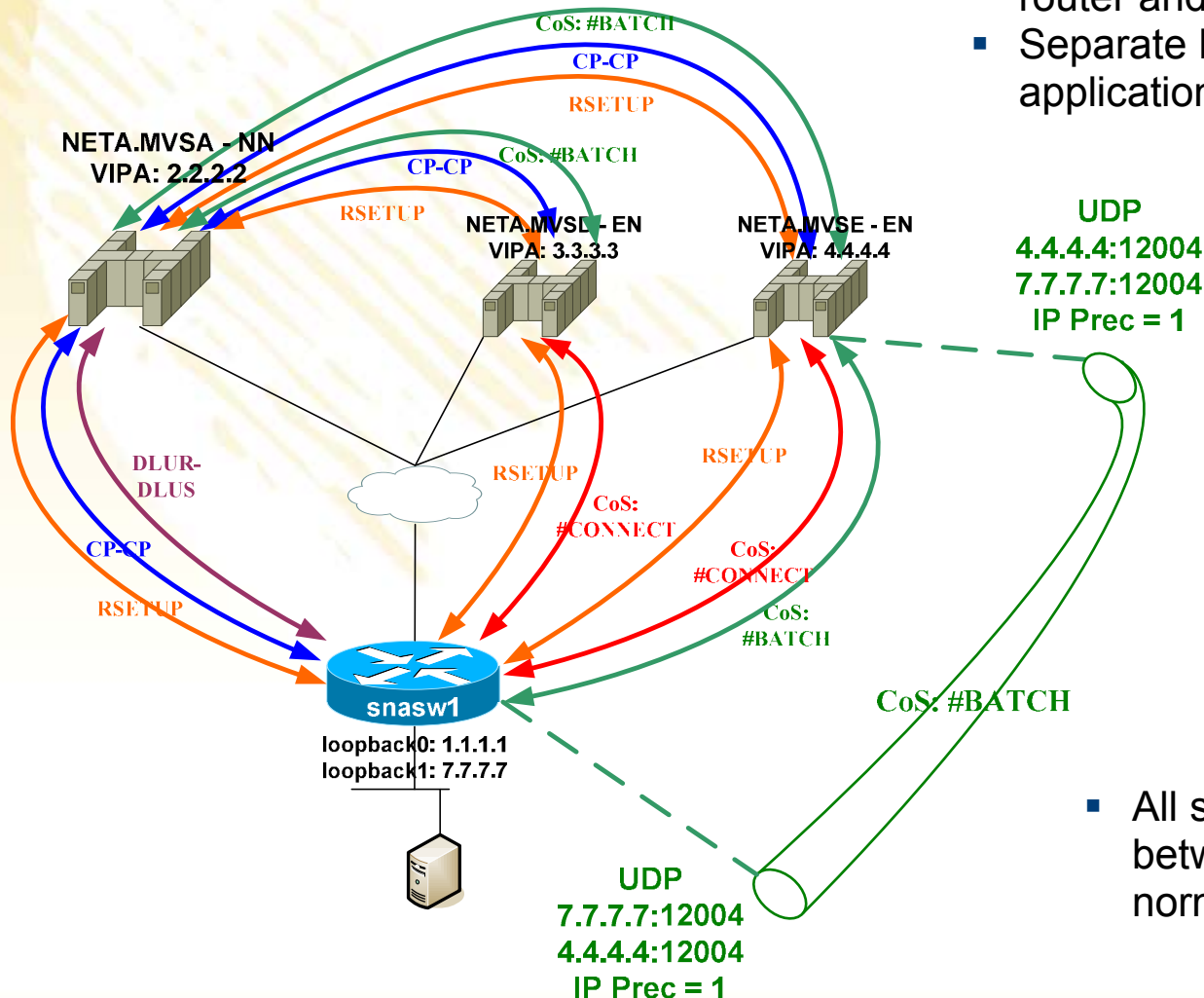

- All session of a particular CoS between SNASw router and target normally traverse the same pipe.

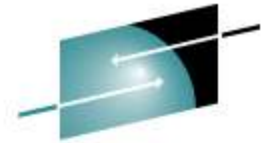

SHARE
Technology • Connections • Results

Enterprise Extender (EE)

- **APPN/HPR in IP Networks (RFC 2353) using UDP sockets 12000 to 12004**
- **Layer 3 IP routing end-to-end**
 - Replace TR in the data Center with Ethernet routers / switches
 - APPN nodes mapped to IP addresses
 - Utilizes IP dynamic routing algorithms (RIP2, OSPF, EIGRP)
 - Proper design includes redundant paths
- **Layer 4 HPR for reliability**
 - Provides end-to-end flow, error, and segmentation control (like TCP)
 - Automatically maps SNA COS to IP precedence bits, preserving SNA traffic prioritization (QoS)
 - Provides non-disruptive rerouting around link failures

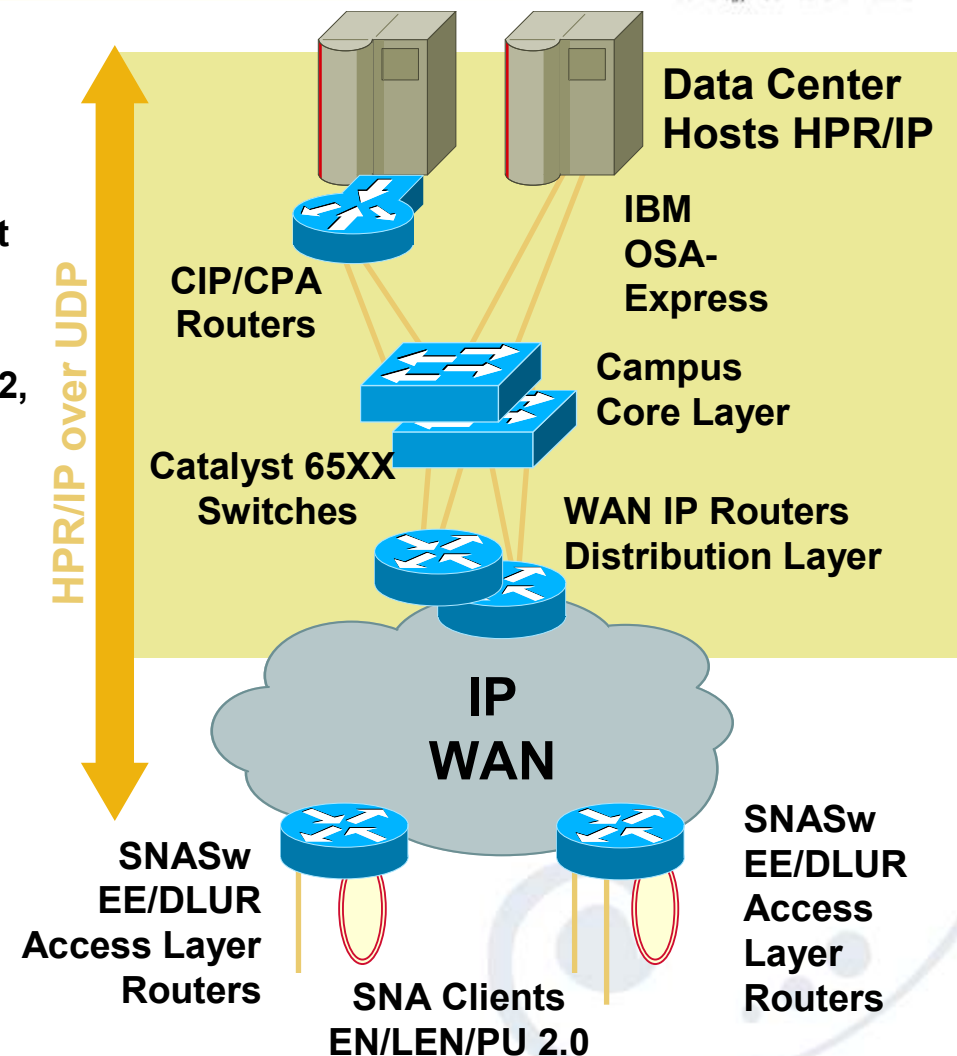

Securing EE over the Intra/Internet

- Firewall ‘gotcha’
 - Allow UDP ports 12000-12004 through firewall for EE (both directions)
- Virtual Private Network
 - IPSec for data encryption and integrity
 - MPLS network for traffic separation
- IPSec can be on the same router as SNASw
 - Allow for CPU load
- Traffic shaping
 - Don’t clear IP precedence marking of SNA traffic (derived from COS)
 - Use WFQ or LLQ or MPLS (with traffic engineered bandwidth)

Secure tunnel over IP or MPLS network

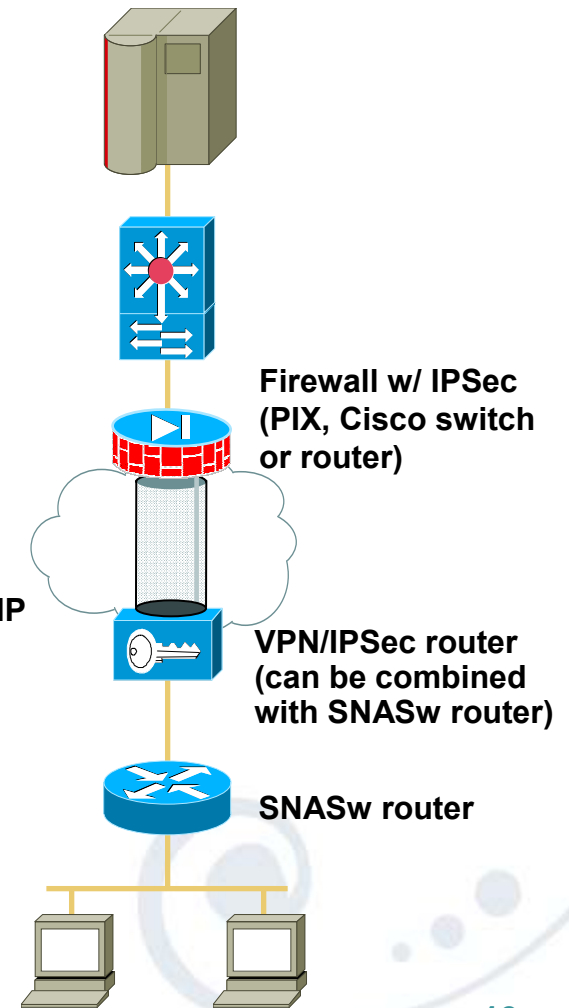

Connection Network

- Simplifies configuration - only define links to primary and secondary **NNS and DLUS**
- Reduces change impact - LPARs added without having to configure new links
- All nodes must be on common network (HPR-IP, LAN, DLSW+), all nodes add same Virtual Routing Node (VRN) to port
- **Add a separate loopback interface and SNASw port for the VRN definition, to avoid a known CP-CP session problem**
- **CNRA** (Connection Network Reachability Awareness) —allows for temporary routing around IP outages
- Must be used to connect peer BrNNs
- Define no-limres on VRN port if using CICS

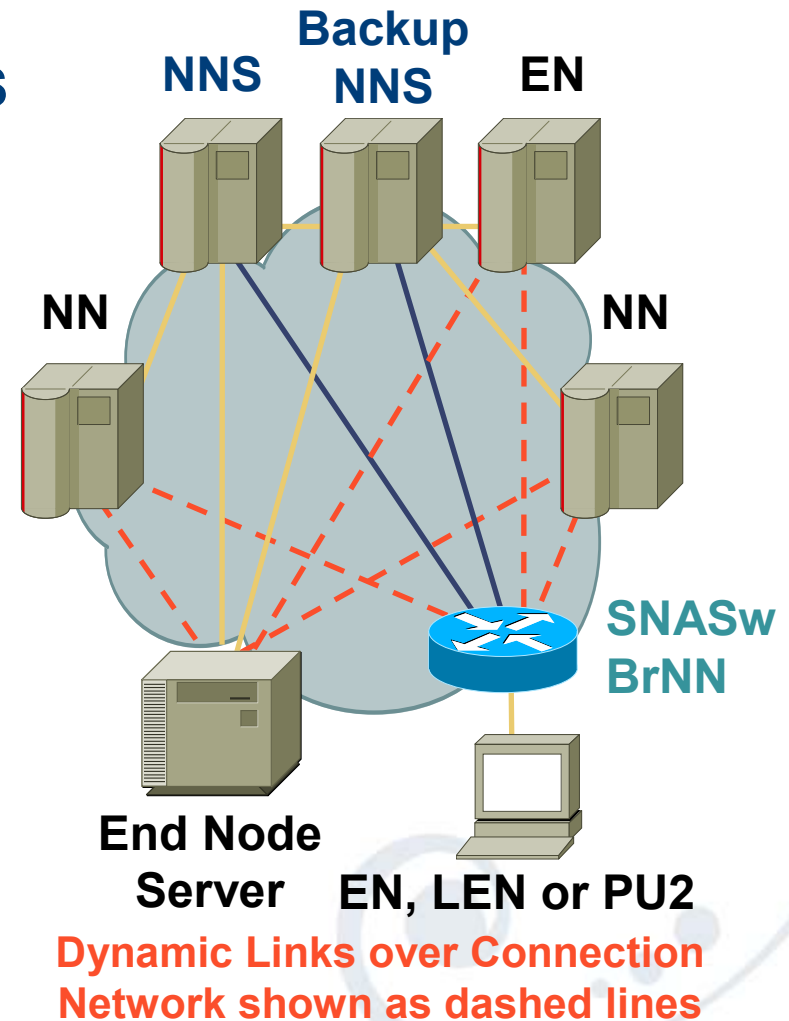

Global Connection Network

- Extend connection network over entire IP network, even across APPN network boundaries
- Only supported on EE ports
- Supported in all SNASw releases
- All SNASw virtual routing nodes (VRNs) are global, but can connect to local VRNs
- NAT is often used at network boundaries, this breaks connection network ... solution is EE hostname support

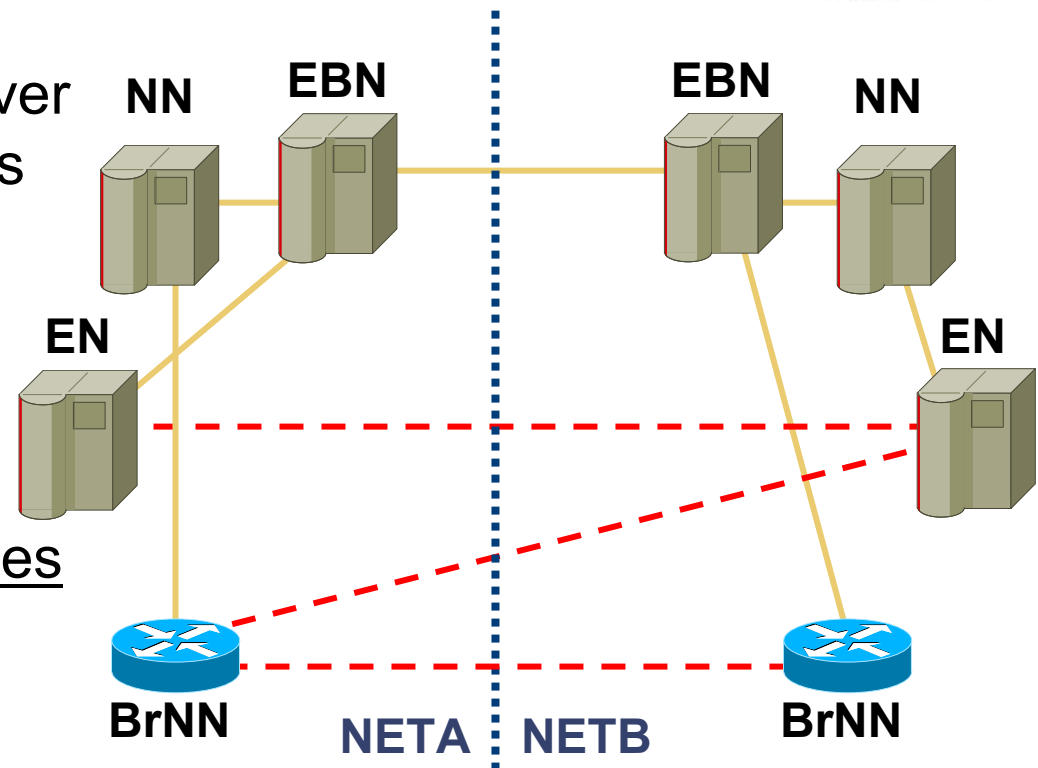

Dynamic Links over Global Connection Network shown as dashed lines

EE Hostname and IPv6 Support

- Hostname support allows connection network to work across NAT
- IPv6 capability added to SNASwitch in IOS version 12.4
- **Hostnames are optional for IPv4 but must be used for IPv6 EE**

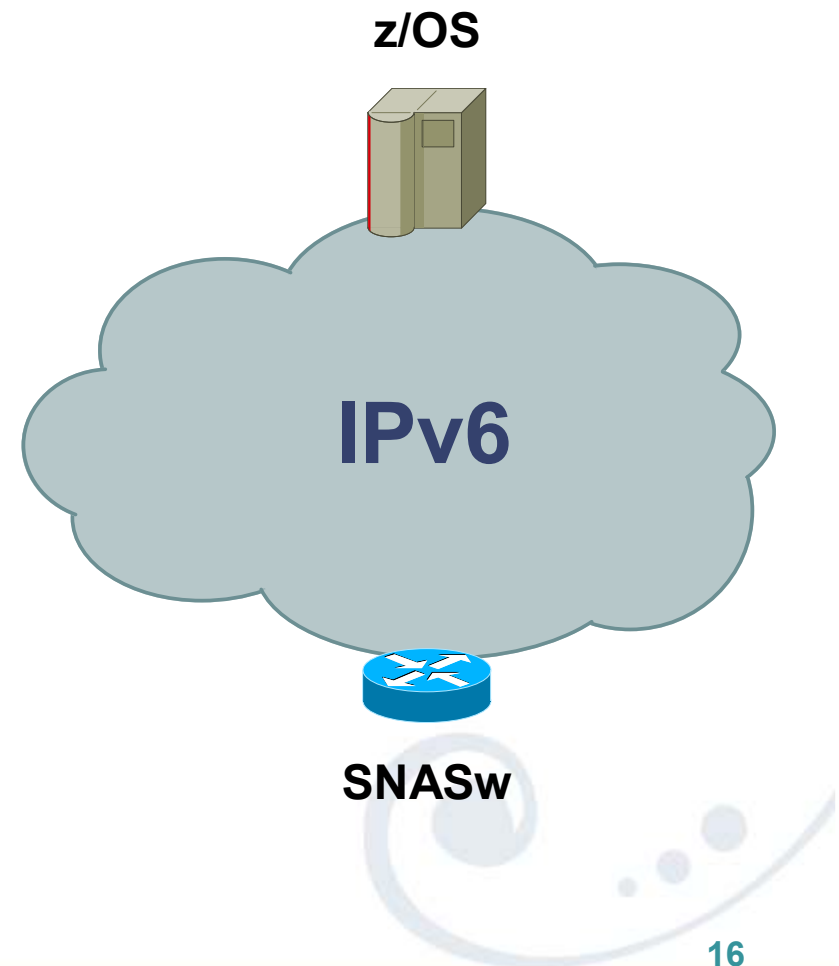

Agenda

- Concepts
- Design Considerations
- Configuration
- Troubleshooting Tools

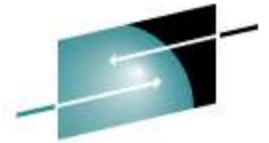

SNASw Supported Interfaces

- **hpr-ip (Enterprise Extender)**
 - Use ip addresses
 - Any IP routed interface (Ethernet, FastEthernet, etc.)
 - Loopback is preferred
- **All other connections**
 - Use MAC/SAP addresses
 - Real interfaces
 - Ethernet, FDDI, ATM LANE, TokenRing
 - Can be connected via HSRP standby mac-address
 - Virtual interfaces
 - VDLC (Virtual Data Link Control)
 - *DLSW+ remote (IP or direct)*
 - *DLSW+ local (QLLC or SDLC)*
 - VTOK (Virtual Token Ring)
 - *Bridged (CIP/CPA, Frame Relay BAN)*

SNASw and DLSw+ Comparison

DLSw+	SNASw
No SNA Routing	Provides SNA Routing Services
SNA/NetBIOS Transport over IP between DLSw+ Peering Routers	SNA Transport over IP between Host and SNASw (EE) Router
Sessions drop when circuit drops	Sessions do not drop when link drops over HPR portion of session path
No SNA Boundary Function Support	SNA Boundary Function Support (DLUR)
SNA COS to IP TOS Mapping Requires APPN (SNASw)	Automatically preserves SNA Session Priority by Mapping APPN COS to IP TOS
No IPv6 support	IPv6 fully supported including hostname support for GVRN

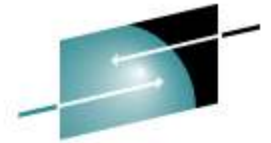

Advantages of SNASw/EE to the Branch

- Simple, efficient design
 - No DLSw+ peers to manage
 - Collecting traces much easier with only one branch's traffic
- Upstream redundancy
 - Layer 3 IP network redundancy and routing protocols from branch
- Downstream options
 - Ethernet or TR
 - Redundancy strategies include Ethernet HSRP, VTOK / TR source-route bridged, Ethernet with canon/non-canon device
 - Local DLSW with VDLC port (for SDLC or QLLC)
- Most cost effective when part of new branch strategy (i.e. VoIP rollout)

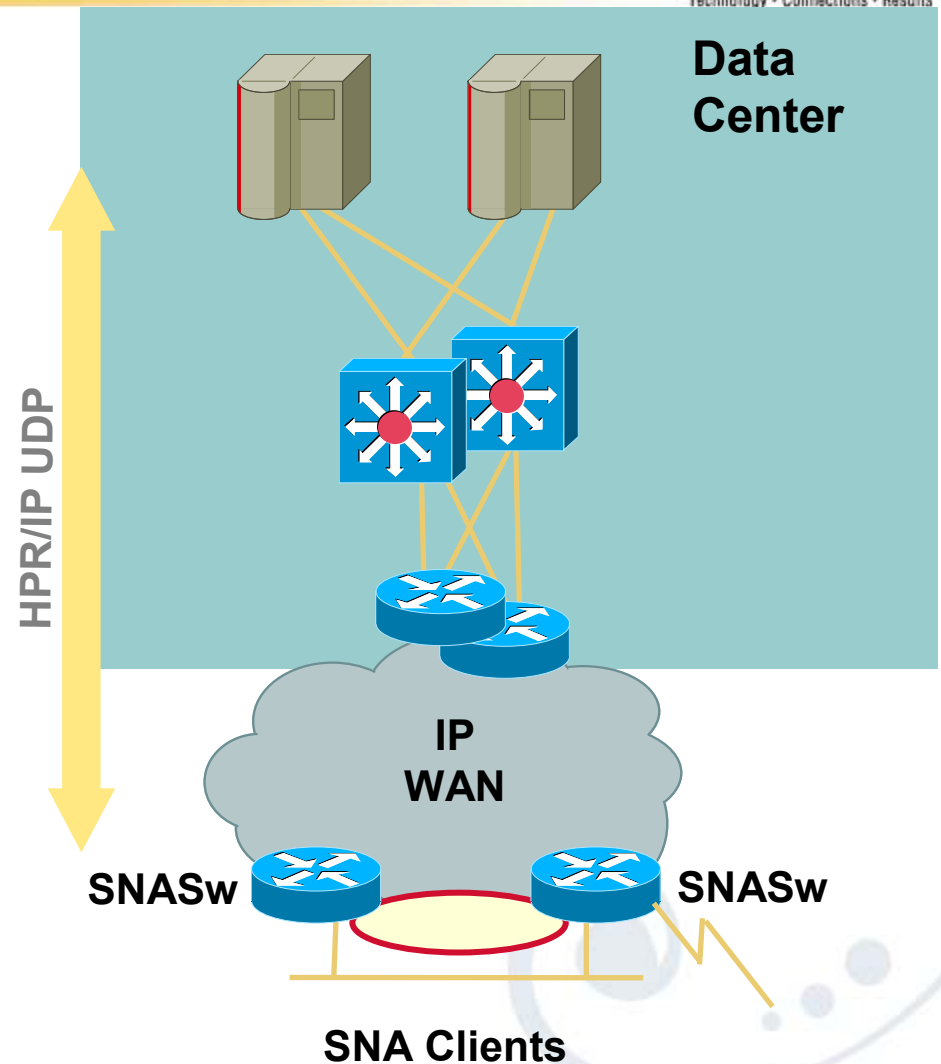

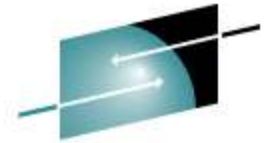

Branch Redundancy with HSRP

- Hot Standby Router Protocol (HSRP) via Ethernet
 - HSRP supports duplicate MAC addresses and multiple standby groups
 - When one router goes down the other router in the same standby group becomes active
 - HSRP can also take action based on events such as an interface shutdown or loss of IP routing
 - 'upstream' IP network must be redundant to avoid black-hole effect

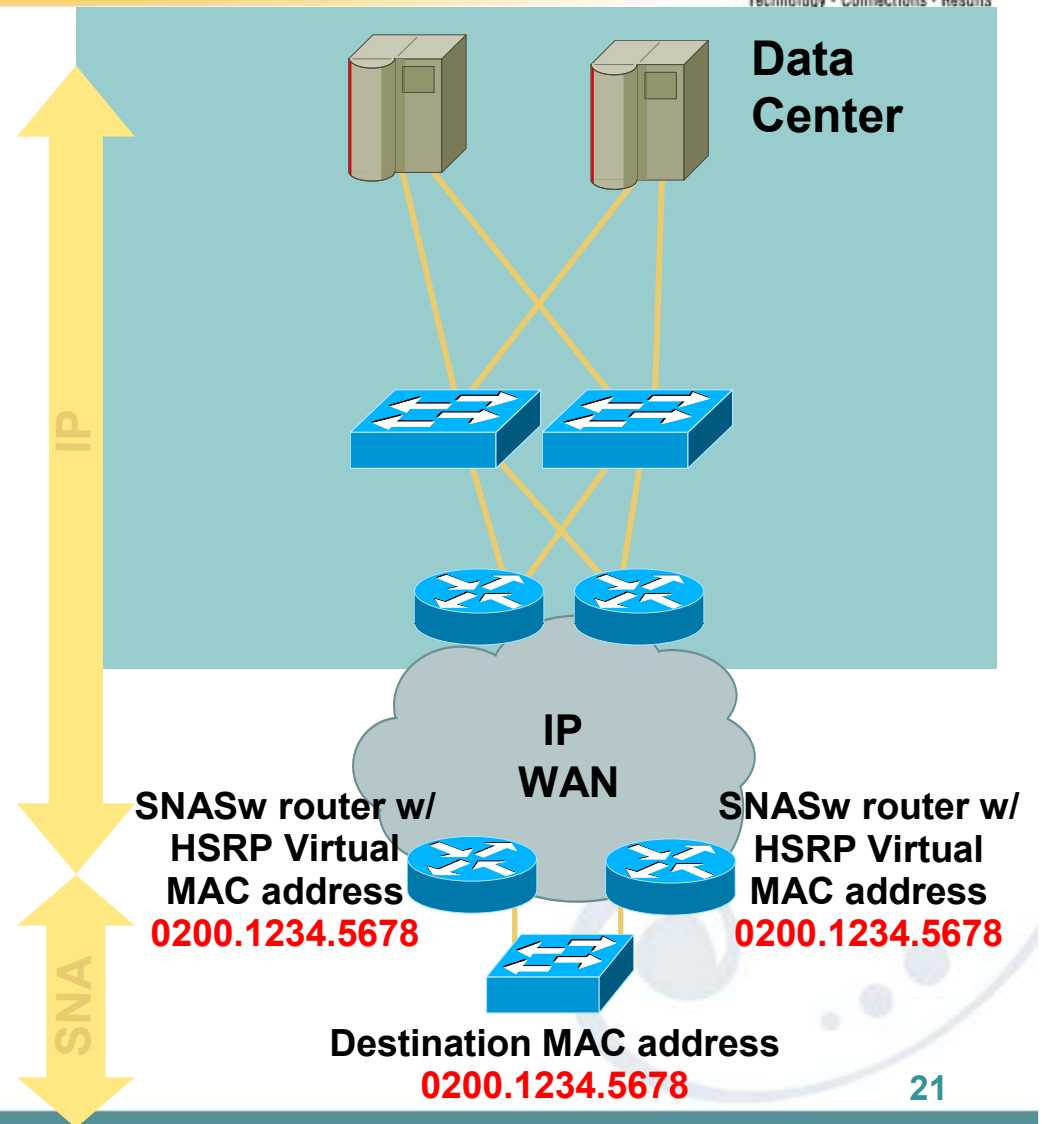

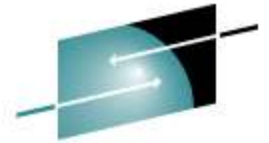

Advantages of SNASw/EE in Data Center

- Don't have to change existing DLSw+ network
 - Provides for stable migration path
 - Customer may be comfortable with existing DLSW infrastructure
- SNASw works with DLSw+
 - Can be on the same router using a snasw VDLC port (preferred)
 - Can be on separate routers using TR/SRB between
 - EE upstream to host
- Generally lower cost
 - No need to upgrade routers or IOS in the branch just for SNASwitch

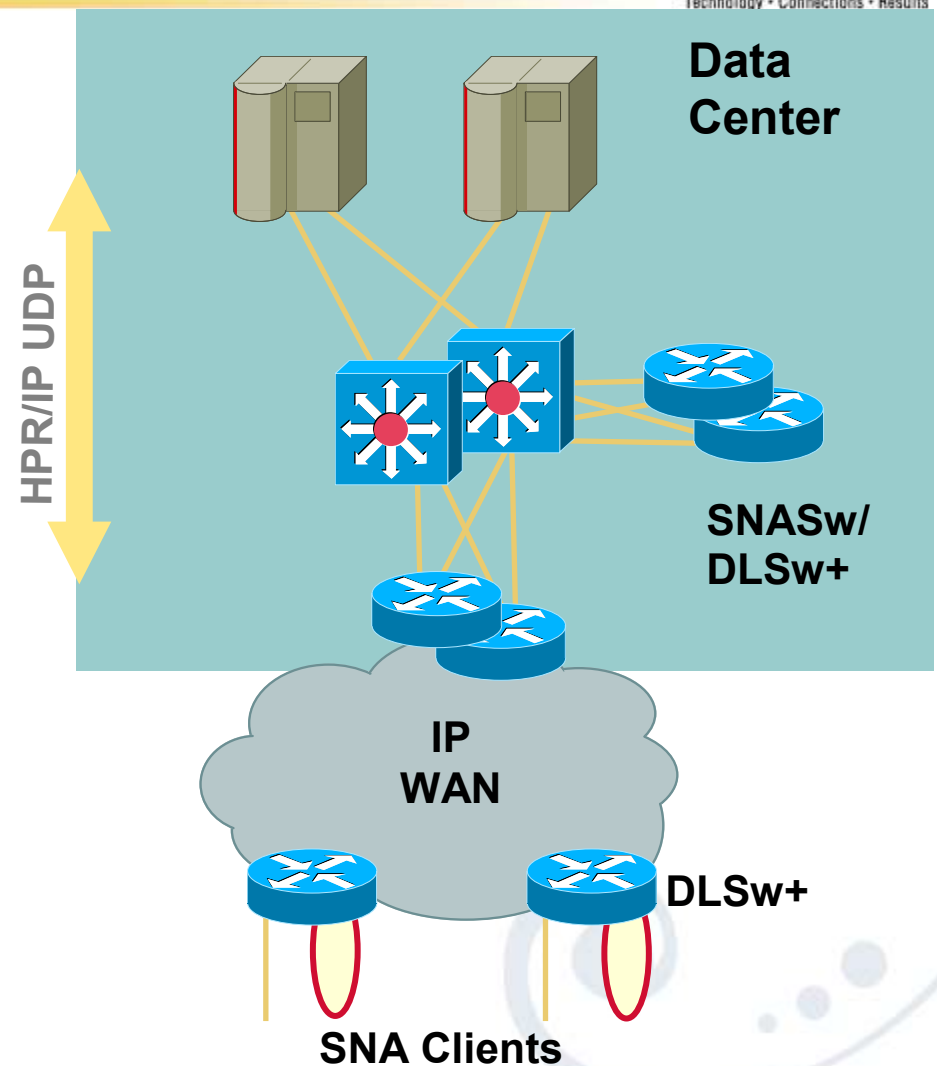

Branch Redundancy with DLSw+, SNASw in the Data Center

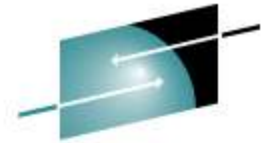

SHARE
Technology • Connections • Results

- Upstream redundancy
 - Layer 3 IP network redundancy and IP routing within Data Center
- Head-end redundancy via multiple active peers/ports or back-up peers
 - Up to 4 active peer paths cached
 - Default is fault-tolerant mode (first response)
 - Customize using cost
 - Load-balancing capability (round-robin or circuit count)
 - nns-required keyword on snaswitch port
- LAN redundancy
 - Ethernet with DLSw+ Ethernet Redundancy or TR / VTOK source route bridge

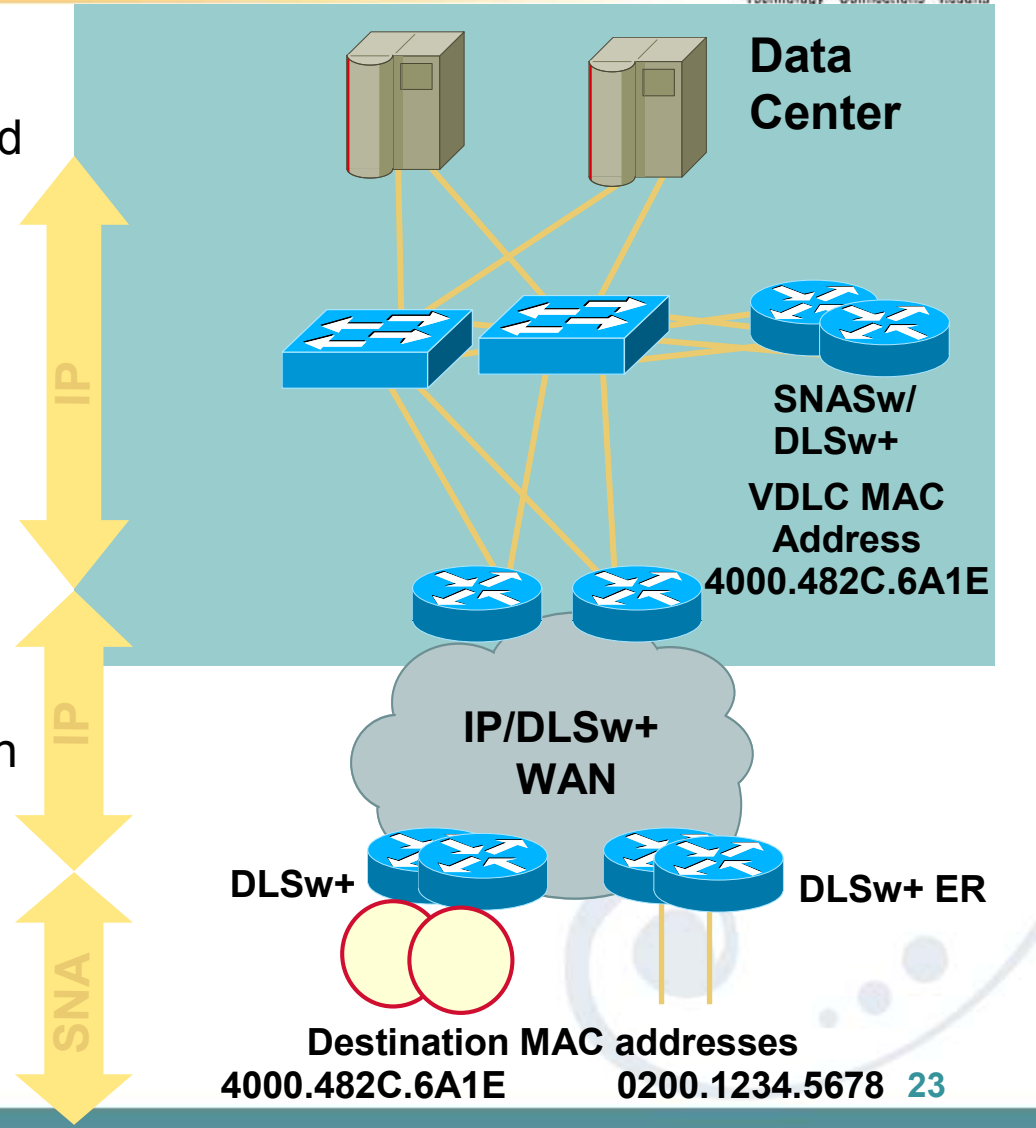

Destination MAC addresses
4000.482C.6A1E 0200.1234.5678 23

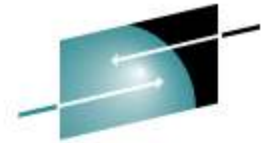

SHARE

Technology • Connections • Results

DLUR/S Redundancy

- Each SNASw DLUR has a backup (i.e. HSRP in branch or DLSw in data center)
- Normal DLUS configuration - each SNASw pair specifies same DLUS pair (primary / backup)
 - Each PU must be defined in one or the other DLUS
- Alternate DLUS configuration – each SNASw router uses its NNS as DLUS
 - Requires that each PU be defined in each potential NNS/DLUS
 - May require DUPDEFS on VTAM

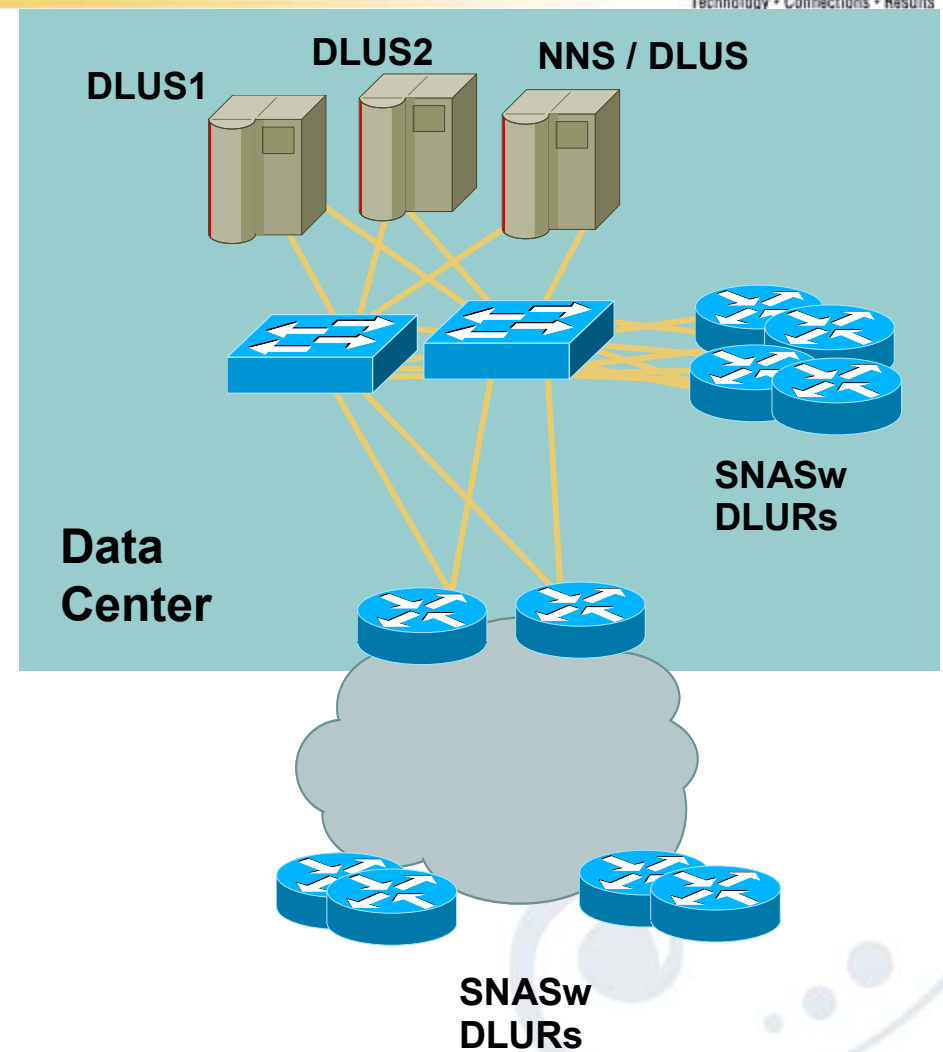

Selecting the Right Platform and Cisco IOS



- Platforms: low-end (branch), mid-range (distribution layer), high-end (data center)
 - 26xxXM, 28xx, 36xx, 37xx, 38xx, 7200, 7300, 7400,
 - **Newer platforms may or may not support IBM Feature Set.**
- Cisco IOS® software release 12.1 and higher
 - Separately purchased IOS feature, see CCO Software Center for SNASw IOS® image combinations
 - **IOS 12.4 and 12.4T has several new diagnostic enhancements**
- CPU requirements for SNASw
 - Allow capacity for failure and redundancy
 - Transaction rate/size most significant factor

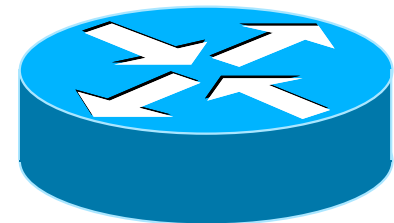

**Recommend
Cisco IOS 12.4T,
latest
maintenance
release from
CCO**

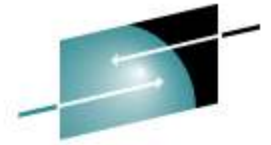

SHARE
Technology • Connections • Results

SNASw Performance by Platform

SNASw (EE) CPU Load With Projected Performance for New (orange labels) Platforms

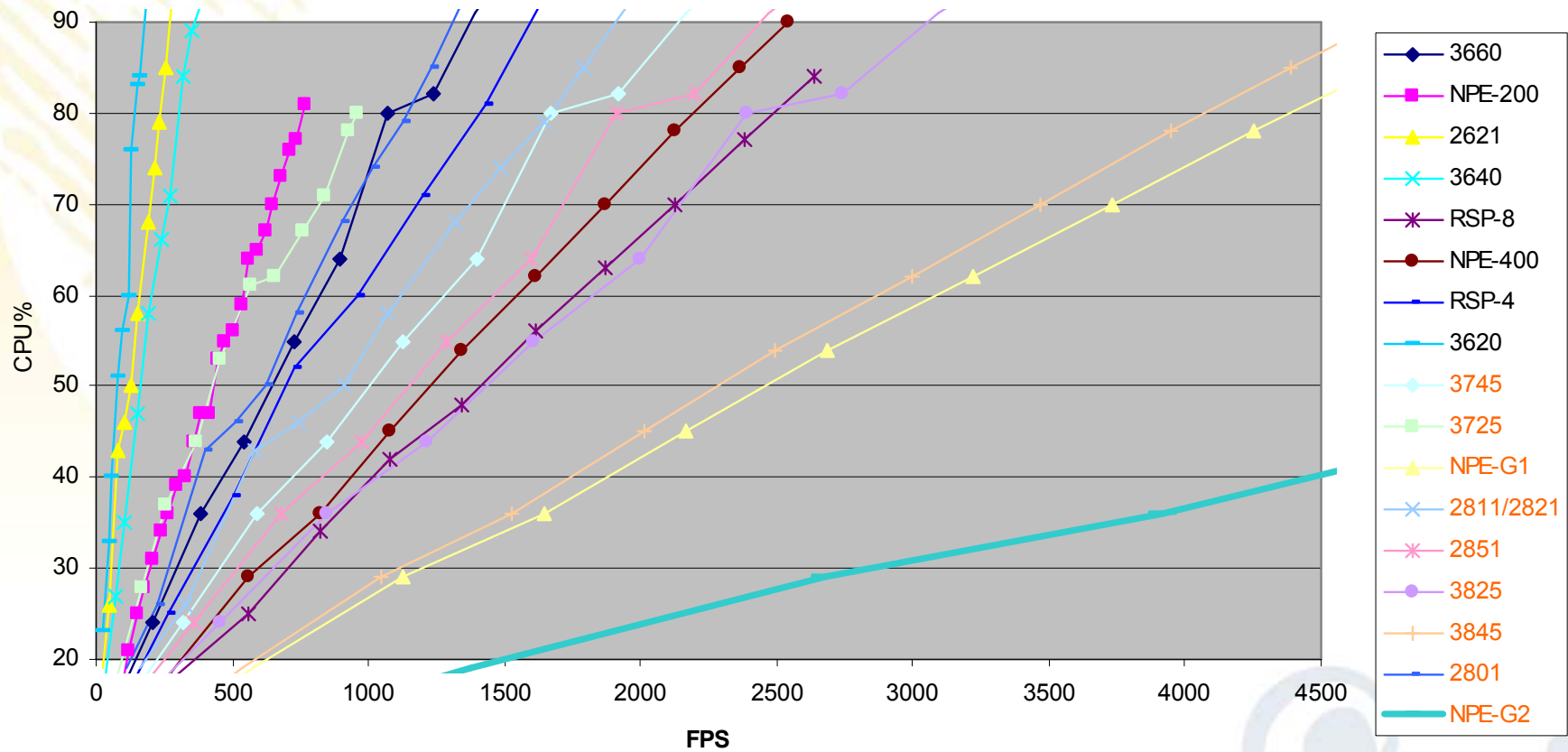

Replacing SNI

- **SNASw does NOT play a role in replacing SNI** (it is used for branches within a network, not to route between networks)
- Inventory SNI partners and types of sessions
 - SNI usually links to another company—making changes requires coordination, cooperation, and probably management support!
- May be able to move to an IP only solution (i.e. file transfer could be done via secure ftp)
- Next preference is EBN/EE
- Other possibilities...
 - Communication Controller for Linux (CCL)/DLSw solution, EBN non EE, Casual Connect, Adjacent (Single-sided) SNI

Agenda

- Concepts
- Design Considerations
- Configuration
- Troubleshooting Tools

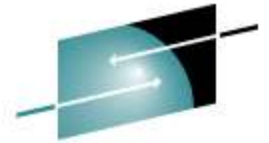

Basic SNASw Configuration

NETA.MVSA - NN

VIPA: 172.18.1.11

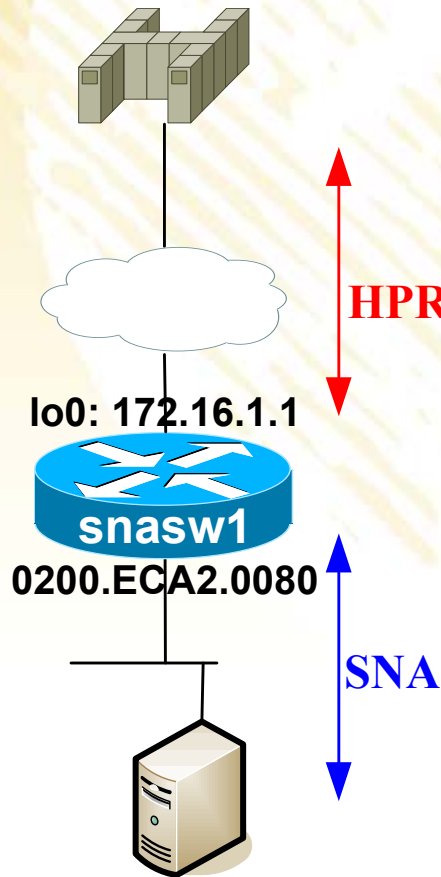

lo0: 172.16.1.1

0200.ECA2.0080

HPR/IP

SNA

```
(config)# snasw cpname NETA.SNASW1
(config)# snasw port EE hpr-ip Loopback0
(config)# snasw port ETH Gig0/0
(config)# snasw link MVSA port EE ip-dest 172.18.1.11
(config)# [int G0/0]
      (config-if)#mac-address 0200.ECA2.0080
```

target MAC:
0200.ECA2.0080

SNASw Main Configuration Items



- **CP Name** Fully qualified unique CP name (1-8 characters) within your SNA NETid network (1-8 characters), i.e. NETA.CP1
- **Port --- Upstream & Downstream**
- **Link --- Upstream Only**

SNASw Ports

SNASw ports act as physical conduits for traffic into and out of the SNASw router.

- Physical
- VDLC
- HPR/IP
- Virtual Token Ring (VTOK)

SNASw Ports – Physical

Physical Interfaces

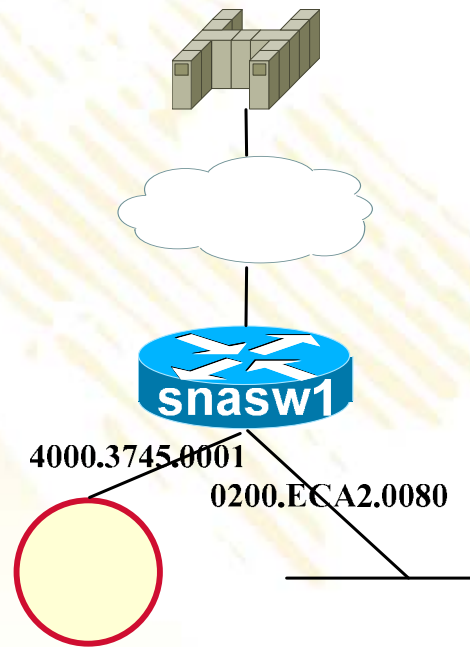

Token Ring

Ethernet

Ethernet/Token Ring – no bridging configuration necessary. Generally requires MAC address configuration to match end device destination address.

Serial (SDLC, QLLC, Frame Relay) – requires DLSw and VDLC to interface with SNASw

SNASw Port: Examples

- ```
(config)# interface loopback0
(config-if)#ip-address 172.18.51.28 255.255.255.0
```
- ```
(config)# interface loopback1
(config-if)#ip-address 172.18.51.29 255.255.255.0
(config)#snasw port EE hpr-ip loopback0 qsize 500
(config)#snasw port EEVRN hpr-ip loopback1 vname IP.IP qsize 500
```
- ```
(config)# snasw port ETH0 FastEthernet0 conntype len
```
- ```
(config)# source-bridge ring-group 50
(config)# dlsw local-peer peer-id 100.1.1.1
(config)# dlsw remote-peer 0 tcp 100.9.9.9
(config)# snasw port DLSW vdlc 50 mac 4000.3640.ddf1 maxbtu 1496 nns-
required
```

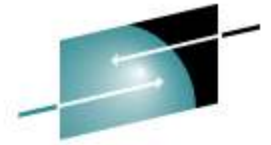

SNASw Ports – HPR/IP

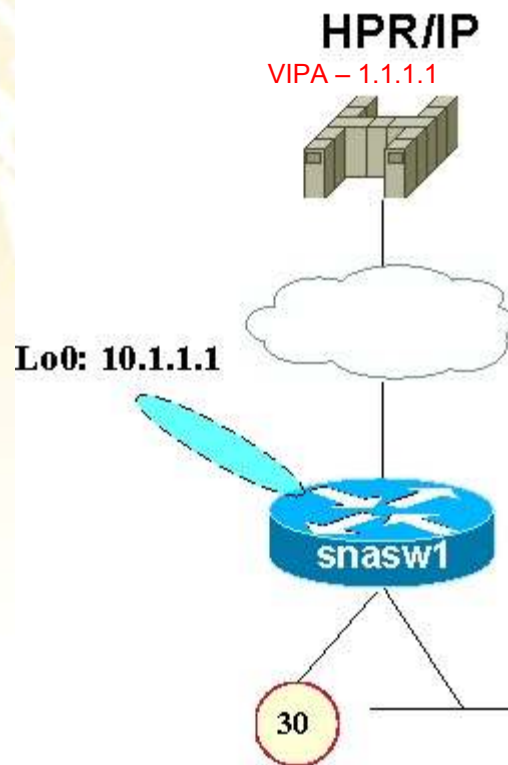

HPR/IP = High Performance Routing over IP
also known as EE = Enterprise Extender

Port that's anchored to an IP interface.
In most designs this is a loopback interface, but can be any valid IP interface.

(config#) snasw port HPRIP hpr-ip Loopback0

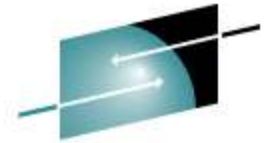

SNASw Links

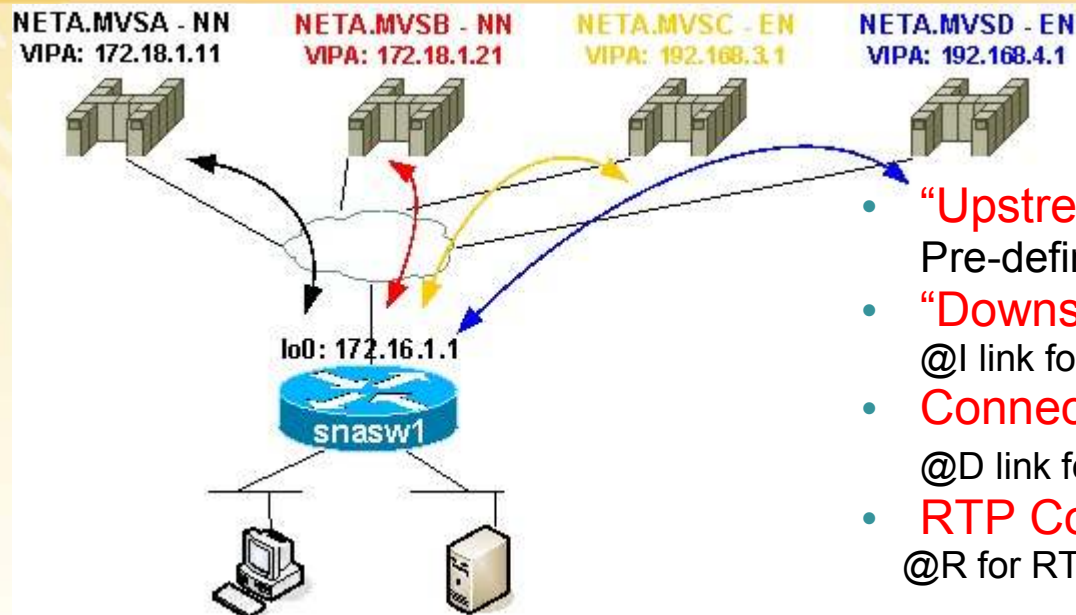

- “Upstream” links are defined
Pre-defined Name
- “Downstream” links are dynamic
@I link for normal downstream links (PU’s)
- Connection network links are dynamic
@D link for connection network links
- RTP Connection rides via these links.
@R for RTP Pipes

- snasw port HPRIP hpr-ip Loopback0
- snasw link MVSA port HPRIP ip-dest 172.18.1.11 nns
- snasw link MVSB port HPRIP ip-dest 172.18.1.21
- snasw link MVSC port HPRIP ip-dest 192.168.3.1
- snasw link MVSD port HPRIP ip-dest 192.168.4.1

SNASw RTP Path Switch

- Non-disruptive path switch
 - Used to route RTPs over failed nodes or TGs
 - Except for some delay, this is transparent to the end LU-LU sessions
- Path Switch Triggers
 - RTP connection failure ---- Most common way
 - Local link failure – SNASw Router End Point
 - Remote link failure – IBM MF End Point
 - Operator request
 - Automatic time (VTAM start option ... PSRETRY)

VTAM Definitions–Start Options & XCAs

- HPR Start Options
 - APPN must be enabled – NODETYPE, NETID, SSCPNAME, etc.
 - HPRPST values should match snasw rtp pathswitch-timers
 - Use DUPDEFS=DEPLU when SMNs are active on more than one VTAM
- XCA major node HPR-IP PORT and GROUPs
 - LIVTIME/SRQTIME/SRQRETRY values should match snasw port hpr-ip ldlc
 - If using connection network, VNNAME should match snasw port vnname

VTAM Definitions—Switched Major Nodes

- Add Switched Major Nodes(SMN) for SNASwitch or use port DYNPU
 - Matches snasw link configured on the router, SNASwitch drives activation
 - Needed on each VTAM that SNASwitch will directly connect to either via a predefined link or a link through a VRN
 - Don't have VTAM connect out to SNASwitch.(don't use DWACT or DWINOP)
 - Use DISC=NO
 - If using DYNPU=YES then create a DYNTYPE=VN model with DISC=NO.
 - Use a TGP or CAPACITY=16M to match SNASwitch
- Downstream PUs and their LUs – Minor changes may be required
 - SMNs for PUs with dependent LUs should be active on all VTAMs that can be a DLUS
 - Remove any LOCADDR=0 definitions, add “snasw location” statements for independent LUs on downstream LEN nodes
 - PATHs must be converted to DLUR dial-out:
 - DLURNAME=netid.cpname, <of SNASw router>
 - DLCADDR=(1,C,TR), <always specify downstream mac address in TR format>
 - DLCADDR=(2,C,name), <snasw downstream port name, can use X with hex EBCDIC name>
 - DLCADDR=(3,X,sap), <downstream device SAP in hex>
 - DLCADDR=(4,X,mac) <downstream device MAC address in hex TR format>

Agenda

- Concepts
- Design Considerations
- Configuration
- Troubleshooting Tools



Traditional IOS troubleshooting

- log messages
 - (sh log – normal Router Log)
 - (sh pd log – SNASw Protocol Log)
- show commands
- ip connectivity
- debugs
- crashinfo and core files

log messages

- **SNASw EVENT messages**

```
12w3d: %SNASW-3-EVENT: Link station MVSX deactivated
```

```
12w3d: %SNASW-3-EVENT: CP-CP sessions deactivated to  
ESPNET.MVSX
```

```
12w3d: %SNASW-3-EVENT: CP-CP sessions activated to NETA.MVSD
```

- Some event's messages are always recorded (dlus, defined link stations)
- Others can be controlled via configuration option

```
R3745R#conf t
```

```
12w3d: %SYS-5-CONFIG_I: Configured from console by console  
Enter configuration commands, one per line. End with  
CNTL/Z.
```

```
R3745R(config)#snasw event ?
```

```
  cpcp          Enable CP-CP session notifications  
  dlc           Enable dlc notifications  
  implicit-ls   Enable implicit link station notifications  
  port         Enable port notifications  
  <cr>
```

log messages

- **SNASw LOG messages**

```
12w3d: %SNASW-6-RTP_LOG_0: INFO - 14001 - RTP Connection has
connected
```

```
12w3d: %SNASW-6-SM_LOG_37: INFO - 14002 - LU6.2 session
activated
```

```
12w3d: %SNASW-6-SS_LOG_12: INFO - 14004 - CP-CP sessions
established
```

- Three levels of severity (information, exception, problem)
- Output to router log is controlled via configuration option
 - Default is exception
 - Set to informational for test environment
 - Set to problem in production (to reduce log messages)

```
R3745R(config)#snasw pdlog ?
```

```
exception      Log problem and exception conditions
```

```
information    Log informational messages, exceptions, and
problems
```

```
problem        Log only severe problems
```

- All LOG messages have detailed record written to pdlog buffer

show commands

- Brief vs. detail
- Output modifier filtering ('include', 'begin', etc.)
- Many snasw commands have additional filtering (i.e. "show snasw lu pu name", "show snasw session pcid", "show snasw link active")

```
R3745R#sh snasw lu ?
```

```
show snasw lu [name <luname>] [pu <puname>]
```

```
[brief | detail]
```

```
brief      Show brief DLUR LU information
```

```
detail     Show detailed DLUR LU information
```

```
name       Show DLUR LUs for a specific LU
```

```
pu         Show DLUR LUs for a specific PU
```

```
|          Output modifiers
```

```
<cr>
```

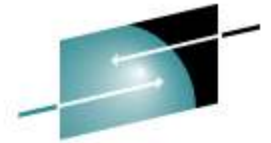
show snasw commands

R3745R#sh snasw ?

class-of-service	Show class of service information
connection-network	Show connection network information
directory	Show directory information
dlctrace	Show information from the dlctrace buffer
dlus	Show DLUS information
ipstrace	Show information from the ipstrace buffer
link	Show link information
lu	Show DLUR LU information
mode	Show mode information
node	Show local node information
pdlog	Show information from the pdlog buffer
port	Show port information
pu	Show DLUR PU information
rtp	Show HPR RTP connection information
session	Show session information
statistics	Show statistics
summary-ipstrace	Show information from the summary-ipstrace buffer
topology	Show topology database information

show snasw port

- Interface must be active ('no shut' - not shutdown) for port to be active

```
2612-BR1#show snasw port
Number of ports 2
```

SNA Ports		HPR		Interface	Address
Name	State	SAP	SAP		
1> ETH0EE	Active			Ethernet0/0	172.18.49.11
2> TOK0	I/f Down	x04	xC8	TokenRing0/0	4000.0704.1776

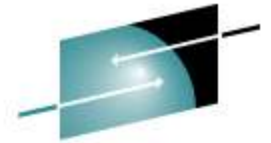

show snasw link

- Link name: defined or dynamic (@I / @U downstream, @D connection network)
- If defined links are not active, check target MAC or IP addresses
- Use “show snasw rtp” to show sessions on an HPR or HPR/IP link

```
2612-BR1#show snasw link
```

```
Number of links 2
```

SNA Links							HPR
Link Name	State	Port Name	Adjacent CP Name	Node Type	Sess	Sup	
-----	-----	-----	-----	-----	-----	-----	
1> @I000002	Active	TOK0	NETB.MARTIN	LEN Node	18	No	
2> MVSDEE	Active	ETH0EE	NETA.MVSD	Network Node	0	Yes	

show snasw rtp

2612-BR1#show snasw rtp

Number of RTP connections 4

SNA RTP Connections

	RTP Name	Local TCID (hex)	Remote CP Name	State	COS	Sess
	-----	-----	-----	-----	-----	----
1>	@R000001	0000000001000B41	NETA.MVSD	Connected	CPSVCMG	2
2>	@R000002	0000000002000B41	NETA.MVSD	Connected	RSETUP	0
3>	@R000003	0000000003000B41	NETA.MVSD	Connected	SNASVCMG	2

show snasw rtp history

- shows rtp performance details in histogram form
- shows ARB allowed send rate and actual receive rate for 3 time periods:
 - Last 60 seconds
 - Last 60 minutes
 - Last 72 hours
- Additionally shows:
 - ARB “normal” responses – OK to increase rate, no delay in network
 - ARB “slowdown” responses – Reduce rate, delay detected
 - Gaps – indicates packet loss

```
R3745R#sh snasw rtp history name @R000025
Total number of RTP connections 4
```

```

SNA RTP Connections
RTP Name  Local TCID (hex)  Remote CP Name  State  COS  Sess
-----  -
1> @R000025  0000000019000D23  NETA.MVSD      Connected  #INTER  1

```

```
R3745R 07:16:15 AM Saturday Aug 31 2002 UTC
```

```
...
```

show snasw session

- Endpoint, Intermediate, and Intermediate DLUR sessions are shown

```
2612-BR1#show snasw sess
Number of local endpoint sessions 4
```

```
SNA Local Endpoint Sessions
PCID (hex)          Partner LU Name    Link/RTP  Mode      COS
-----
1> C3BBD36E95C5AC8C NETA.MVSD         @R000005  CPSVRMGR  SNASVCMG
2> D51F15B05FB78DA1 NETA.MVSD         @R000005  CPSVRMGR  SNASVCMG
3> C3BBD36E95C5AC8A NETA.MVSD         @R000002  CPSVCMG   CPSVCMG
4> D51F15B05FB78D9A NETA.MVSD         @R000001  CPSVCMG   CPSVCMG
```

```
Number of intermediate DLUR sessions 1
```

```
SNA DLUR Assisted Intermediate Sessions
PCID (hex)          Primary LU Name    Secondary LU Name  Mode      COS
-----
1> C3BBD36E95C5A198 NETA.ECHOMVSD     NETA.LEF00101    #CONNECT
```

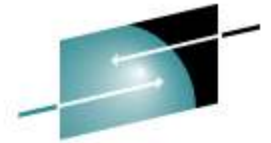
show snasw dlus

- At least one DLUS should be active if there are PUs to be served
- Both primary and backup DLUS can be active

```
2612-BR1#show snasw dlus
```

```
Number of Dependent LU Servers 2
```

SNA Dependent LU Servers				
DLUS Name	Default?	Backup?	Pipe State	PUs
-----	-----	-----	-----	-----
1> NETA.MVSA	No	Yes	Inactive	0
2> NETA.MVSD	Yes	No	Active	1



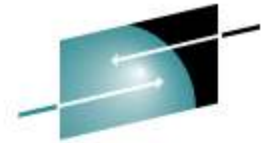

show snasw pu

- When a downstream link is activated with an XID that indicates ACTPU is required, a pu is created automatically
- The pu name will be dynamic (beginning with @P) until ACTPU is received containing the PU's name

```
2612-BR1#show snasw pu
Number of DLUR PUs 1
```

SNA DLUR PUs			
PU Name	PU ID	State	DLUS Name
-----	-----	-----	-----
1> APPNMA29	05D00000	Active	NETA.MVSD

show snasw pu detail

- “detail” command shows FSM history, used for troubleshooting by Cisco tech support

```
2612-BR1#show snasw pu det name APPNMA29
Number of DLUR PUs 1
```

```
1>
PU name APPNMA29
Backup DLUS name
Active DLUS name NETA.MVSD
PU ID (IDBLK/IDNUM) X'05D00000'
PU location Downstream
PU status Active
DLUS session state Active
Automatic Network Shutdown support Continuous
DLUS retry timeout (seconds) 0
DLUS retry limit 0
DLUS pipe PCID X'D51F15B05E9ADF01'
DLUS pipe CP Name NETA.R2612BR1
PU FSM history (00,01) -> (01,03) -
>(02,04) -> (02,06) -> (03,11) -> (03,07) ->04
```

SNASwitch Diagnostic Quick Reference

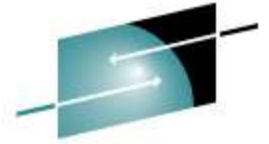

	On Snaswitch Router	On VTAM	other commands (, etc.)
SNASw control point, topology, directory	show snasw node show snasw topo show snasw dir	D NET,=cpname,E D NET,ID=cpname,E D NET,TOPO D NET,DIRECTRY	
DLUR / DLUS	show snasw dlus	D NET,DLURS	
upstream links	show snasw link * link names from configuration and those beginning with @D	D NET,ID=linkname,E * where linkname was learned from IST116I on D NET,ADJCP above	
downstream links / PUs	show snasw pu show snasw link * link names beginning with @I and @U	D NET,ID=puname,E * using puname learned from IST089I on D NET,ID=cpname above	show circuit show local-circuit show llc
RTP pipes	show snasw rtp	D NET,RTP	
sessions	show snasw sessions * can specify pcid	D NET,SESSIONS * can specify SID=pcid	
where to look for error messages?	show snasw pdlog all i string snasw dump pdlog	on the VTAM and / or Netview console	on the router log
traces	snasw dlctrace snasw msgdump	VIT, buffer, packet, can use msgdump Alert as trigger	debug , debug cls, debug llc
test potential ee link connectivity	ping * use extended options to specify source interface or ip address	D NET,EEDIAG,TEST=YES, IPADDR=(srcipaddr,destipaddr), LIST=DETAIL * z/OS 1.8 and above and IOS 12.4(12) and above	
test session between CPs	ping sna <cpname>	D NET,APING,ID=cpname	

#	IP Precedence (default)	Priority	Usage
12000	110 (6) Internetwork Control	LDLC	XID, TEST, DISC, DM, XID_DONE_RQ, XID_DONE_REQ
12001	110 (6) Internetwork Control	Network	CPSVCMG(CP-CP), CPSVRMGR(SNASVCMG) and RSETUP
12002	100 (4) Flash Override	High	#INTER #INTERSC
12003	010 (2) Immediate	Medium	#CONNECT
12004	001 (1) Priority	Low	#BATCH #BATCHSC

Problem Determination Log (pdlog)

- Internal SNASw problem determination message logging, always active (default buffer size 500Kb)
- Three classifications of messages: exception, information, problem
- Configuration (optional): type of messages to be sent to console, buffer size and file path for uploading

```
(config)#snasw pdlog problem | exception | info [buffer-size size] [file file-url [timestamp]]
```

Data Link Control Tracing (dlctrace)

- Internal cyclic buffer trace (up to 64MB in size) with low CPU overhead (less than 10%)
- ‘sniffer-like’ trace of packets in and out of the APPN stack

- Optional filtering

```
(config)#snasw dlctrace [buffer-size size] [file file-url  
[timestamp]] [frame-size size | auto-terse] [format brief |  
detail | analyzer] [nostart]
```

```
(config)#snasw dlcfilter [link name] [port name] [rmac mac-  
addr] [rtp name] [type [cls] [hpr-cntl] [hpr-data][isr][xid]]
```

auto-terse: truncate data portion of frame

**format analyzer: generate frame format compatible with sniffer
analyzer program (Sniffer Pro, Ethereal – Wire Shark, etc.)**

Inter Process Signal Tracing (ipstrace)

- Internal tracing between SNASw components
- Significant CPU overhead (about 15-25%)
- Configure with care, usually at request of Cisco Support staff
- Need to dump trace file in binary format for Cisco to interpret (capture of show ipstrace unusable, and has been removed in version 12.4)
- Optional filtering specific to APPN stack components

```
(config)#snasw ipstrace [buffer-size size] [file file-url  
    [timestamp]] [nostart]]  
(config)#snasw ipsfilter am | asm | bm ...
```

Adding PD Tools to the Configuration

```
snasw pdlog exception file tftp://64.102.16.25/BR1-pdlog timestamp
snasw dlctrace buffer-size 3000 file tftp://64.102.16.25/BR1-dlctr
timestamp
snasw cpname NETA.R2612BR1
snasw dlus NETA.MVSD backup NETA.MVSA
snasw port ETH0EE hpr-ip Ethernet0/0
snasw port TOK0 TokenRing0/0 conntype len
snasw link MVSDEE port ETH0EE ip-dest 172.18.1.41
```

Show snasw pdlog

2612-BR1#

*Feb 10 10:49:40.951: %SNASW-3-EVENT: Pipe to DLUS activated, DLUS name = NETA.MVSD

*Feb 10 10:49:40.951: %SNASW-3-DLUR_LOG_2: EXCEPTION - 145 - REQACTPU rejected

2612-BR1#sho snasw pdlog id 145 det

Problem Determination Log Output

**** 00000145 - EXCEPTION 512:582 (0) ****

REQACTPU rejected with following sense code

Sense code = 0x08060000

DLUS name = NETA.MVSD

PU name = @P000003

XID =

```

0000 3264EDED ED020000 80081100 00000000 .....
0010 00010B41 0005C000 00000007 000E09F4 .....{.....4
0020 C5D4C4E2 D7E4F0F2 103A0013 11091000 EMDSPU02.....
0030 10F7F2F0 F04040F2 F1F2F8F8 F0F22611 .7200 2128802..
0040 0C0804F1 F2F0F4F2 F20908C3 F7F2F0F0 ...120422..C7200
0050 60C11206 8389A283 9640E2D5 C140D996 -A..cisco SNA Ro
0060 A4A38599 uter

```

From ../dcl/ndrpufsm.c 406 :at 10:49:40, 10 February 02

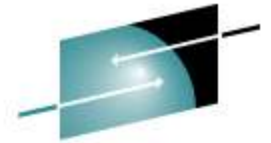

Show snasw dlctrace

```
2612-BR1#show snasw dlctrace
```

```
237331 @I000006 Out sz:100  XID 3 NP NETA.R2612BR1  xid:FFF00000
237332 @I000006 In  sz:96   XID 3 NP NETA.MARTIN   xid:05D00000
237333 @I000006 Out sz:223  SET_MODE Rq
237334 @I000006 In  sz:223  SET_MODE +Rsp
```

```
2612-BR1#show snasw dlctrace detail id 237332
DLC Trace Output
```

```
237332 @I000006 In  sz:96   XID 3 NP NETA.MARTIN   xid:05D00000
06:19:02.65, 7 March 1993
0000 326005D0 00000000 8034C100 00000080 *.-.}.....A.....*
0010 00010B41 00078900 01000004 000E0CF4 *.....i.....4*
0020 D5C5E3C1 4BD4C1D9 E3C9D50E 09F7D3C9 *NETA.MARTIN..7LI*
0030 D5D2F0F0 F0F11028 00111104 0E02F5F6 *NK0001.....56*
0040 F2F1F2F5 F4F0F0F2 F1F01611 03130011 *2125400210.....*
0050 F8F5F6F5 F0F0F0F0 F0F0F0F0 F0F0F0F0 *8565000000000000*
```

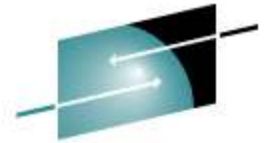

Manual dumping of traces and pdlog

```
(config)# snasw dlctrace buffer-size 10000
2612-BR1#snasw dump dlctrace
Type of DLC trace file (b[rief], d[etail], a[nalyzer], q[uit]) [d]?
analyzer
Address or name of remote host []? 64.102.16.25
Remote filename [2612-BR1-dlctrc]?
!!!!!!!!!!!!!![DLC trace dumped OK]
```

```
(config)# snasw dlctrace file tftp://64.1.1.2/BR1-dlc format analyzer
timestamp
2612-BR1#snasw dump dlctrace
!!!!!!!!!!!!!![DLC trace dumped OK]
```

```
2612-BR1#snasw dump all
Attempting to dump all traces :
!!![PD log dumped OK]
!!!!!!!!!!!!!![DLC trace dumped OK]
!!!!!!!!!!!!!![IPS trace dumped OK]
```



Automatic dumping (snasw msgdump)

- To trigger stop/dump of the traces/pdlog when getting log message

```
%SNASW-3- DLUR_LOG_2 : PROBLEM - 358 - REQACTPU rejected
```

- Configure:

```
2612-BR1 (config)#snasw msgdump DLUR_LOG_2  
[writecore]
```

- Must have file *file-url* coded in configuration statement for traces/logs to be dumped

```
2612-BR1 (config)# snasw dlctrace buffer-size  
5000 file tftp://64.1.1.2/BR1-dlctrc  
timestamp
```

- Alert issued to network focal point (NetView NPDA)
- Can also specify that a core file should be captured (writecore)

Other diagnostic commands

- **snasw stop/start arbdata**
 - Monitoring of ARB algorithm values for an RTP connection (by local TCID)
- **debug snasw** (api, dlc, ips, link, port)
 - pdlog/dlctrace/ipstrace are usually much better
- **debug cls** (errors, state, message, vdlc)
 - Cisco's link services component
- **debug llc** (errors, state, packet)
 - llc2 component
- **debug dlsw** (peers, reachability)
 - Useful with snasw vdlc port
- **show dlsw peers, circuits**
 - Useful with snasw vdlc port

Caution:

These commands can generate a lot of output, so you should only use them when requested by Cisco Support staff, and only when logging to a buffer (not the console).

SNA Network Ping command

```
2612-BR1#ping sna neta.mvsd
```

```
2612-BR1#
```

```
SNA APING successful
```

```
Partner LU name
```

```
NETA.MVSD
```

```
Mode name
```

```
#INTER
```

```
Allocate duration
```

```
176 ms
```

```
Duration statistics
```

```
Min = 20 ms Ave = 22 ms
```

```
Max = 24 ms
```

Commands for EE/IP Diagnosis

- Extended Ping to destination IP address:

```
2612-BR1# ping
```

```
Protocol [ip]:
```

```
Target IP address: 172.18.1.41
```

```
...
```

```
Extended commands [n]: y
```

```
Source address or interface: 10.20.10.10
```

```
Type of service [0]:
```

```
...
```

```
Type escape sequence to abort.
```

```
Sending 5, 100-byte ICMP Echos to 172.18.1.41, timeout is 2  
seconds:
```

```
Packet sent with a source address of 10.20.10.10
```

```
!!!!!!
```

```
Success rate is 100 percent (5/5), round-trip min/avg/max =  
12/12/16 ms
```

```
2612-BR1#
```

- Traceroute
- LDLC Probe – D NET,EEDIAG,TEST=YES,IPADDR=(x.x.x.x,y.y.y.y)

Show tech-support enhancements

- show tech-support command has been enhanced in 12.4(22) to include more SNASwitch specific information:
- Existing:
 - show snasw node
 - show snasw statistics
 - show snasw dlus detail
- Added:
 - show snasw pu
 - show snasw pu not-active detail
 - show snasw link
 - show snasw link not-active detail
 - show snasw port not-active detail
 - show snasw session local
 - show snasw session not-active detail
 - show snasw rtp
 - show snasw pdlog last 50 detail

Simple PD Exercise: PU Cannot Connect

- End-user just replaced old workstation; he calls the helpdesk to report that he cannot connect to the host



Check Status of PU on DLUS

```
0280  D NET, ID=APPNRA12, E
0090  IST097I DISPLAY ACCEPTED
0090  IST075I NAME = APPNRA12, TYPE = PU_T2 204
0090  IST486I STATUS= CONCT, DESIRED STATE= CONCT
0090  IST1043I CP NAME = APUNAME, CP NETID = NETA, DYNAMIC LU = YES
0090  IST1589I XNETALS = YES
0090  IST136I SWITCHED SNA MAJOR NODE = SWAPPNRA
0090  IST654I I/O TRACE = OFF, BUFFER TRACE = OFF
0090  IST1500I STATE TRACE = OFF
0090  IST1656I VTAMTOPO = REPORT, NODE REPORTED - YES
0090  IST1657I MAJOR NODE VTAMTOPO = REPORT
0090  IST355I LOGICAL UNITS:
0090  IST080I APULU1    CONCT          APULU2    CONCT          APULU3    CONCT
0090  IST080I APULU4    CONCT
0090  IST314I END
```

Check DLUS Console

```
0081  IST680I  CONNECTION REQUEST DENIED - ID = ***NA***  PU GEN NOT SUPPORTED
0090  IST1354I  DLUR NAME = NETA.PO                      MAJNODE = ***NA***
0090  IST1394I  CPNAME = NETA.APU                       STATION ID = 020005D01983
0090  IST314I  END
```

show snasw dlus

```
pogo#sh snasw dlus  
Number of Dependent LU Servers 1
```

```
SNA Dependent LU Servers  
DLUS Name      Default?  Backup?  Pipe State  PUs  
-----  
1> NETA.MVSD    Yes      No       Active      67
```

DLUS Name	Default?	Backup?	Pipe State	PUs
1> NETA.MVSD	Yes	No	Active	67

Check Router Log

```
1w3d: %SNASW-3-DLUR_LOG_2: PROBLEM - 2275 - REQACTPU rejected
```

show snasw pdlog detail

```
pogo#sh snasw pdlog id 2275 detail
Problem Determination Log Output
```

```
**** 00002275 - PROBLEM 512:582 (0) ****
REQACTPU rejected with following sense code
Sense code    = 0x08060000
DLUS name     = NETA.MVSD
PU name       = @P000122
```

```
From ../dcl/ndrpufsm.c 408 :at 3:17:06, 10 March 00
```

```
Note: XID information added in IOS 12.3(13) and later
```

Look Up Sense Code

From *SNA Formats* reference book

0806 Resource Unknown: For example, the request contained a name or address not identifying a PU, LU, SSCP, link, or link station known to the receiver or the sender.

Bytes 2 and 3 following the sense code contain sense code specific information. Settings allowed are:

0000 No specific code applies.

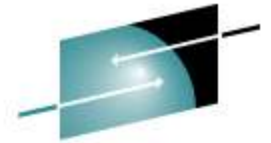

Check in dlctrace

```
pogo#snasw stop dlctrace
```

```
DLC tracing stopped
```

```
pogo#sh snasw dlc all | i ReqActPU
```

```
607837 MVSDEE    Out sz:284  HPR fmh5 DLUR Rq ReqActPU
607846 MVSDEE    In  sz:108  HPR fmh5 DLUR -Rsp ReqActPU    08060000
607912 MVSDEE    Out sz:284  HPR fmh5 DLUR Rq ReqActPU
607921 MVSDEE    In  sz:108  HPR fmh5 DLUR -Rsp ReqActPU    08060000
607981 MVSDEE    Out sz:284  HPR fmh5 DLUR Rq ReqActPU
607990 MVSDEE    In  sz:108  HPR fmh5 DLUR -Rsp ReqActPU    08060000
608050 MVSDEE    Out sz:284  HPR fmh5 DLUR Rq ReqActPU
608059 MVSDEE    In  sz:108  HPR fmh5 DLUR -Rsp ReqActPU    08060000
```

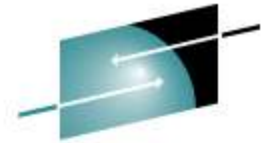

Verify name in dlctrace

```
pogo#sh snasw dlc id 608050 detail
DLC Trace Output
```

```
608050 MVSDEE   Out sz:284  HPR fmh5 DLUR Rq ReqActPU
TCID(2ECB1E72 BDD)  DL(E8) BSQ(96) SM EM ST(86) SA(0 7F000019)
03:38:10.38, 10 March 2000
0000 C600D000 00000000 0000FF00 2ECB1E72 *F.}.....*
0010 00000BDD 3004000A 000000E8 00000096 *.....Y...o*
0020 050E0000 00000001 00000086 00000000 *.....f....*
0030 00000000 5C000001 00000000 7F000019 *...*....."....*
0040 0B910129 0502FF00 03D00000 0422F0F0 *.j.....}....00*
0050 F6001007 D5C5E3C1 4BD7D6B4 AA3B5DC2 *6...NETA.PO...)B*
0060 14000108 78400004 61D8898C 00B01500 *......./Qi.....*
0070 00112C00 00000029 0B800041 023E0000 *.....*
0080 005F8132 5D05D019 83000080 38C10000 *.^a.)}.c....A..*
0090 00008000 010B7100 07890001 00000400 *.....i.....*
00A0 0E09F4D5 C5E3C14B C1D7E40E 09F7D3C9 *..4NETA.APU..7LI*
00B0 D5D2F0F0 F0F11028 00111104 0E02F5F6 *NK0001.....56*
00C0 F2F1F2F5 F4F0F0F2 F1F01611 03130011 *2125400210.....*
00D0 F8F5F6F5 F0F0F0F0 F0F0F0F0 F0F0F0F0 *8565000000000000*
00E0 1C460491 E3D90393 04089410 005ACC84 *...jTR.l..m..!.d*
00F0 FD039504 08964000 12281983 0E510101 *..n..o ....c....*
0100 00000000 00180000 00001260 CECFB8A8 *.....-...y*
0110 BF41263B 07D5C5E3 C14BD7D6 *.....NETA.PO *
```



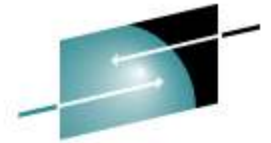

Check PU Definition on the DLUS

APPNRA12 PU	ADDR=01 ,	X
	ISTATUS=ACTIVE ,	X
	MAXPATH=1 ,	X
	MODETAB=ALAMODE ,	X
	MAXOUT=7 ,ANS=CONTINUE ,	X
	DLOGMOD=SX32702S ,	X
	USSTAB=USSSNA ,	X
	CPNAME= APUNAME	



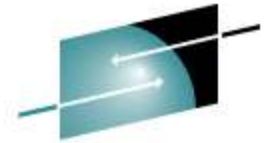

Correct PU Definition (Host or Workstation)

```
D NET, ID=APPNRA12, E
IST097I DISPLAY ACCEPTED
IST075I NAME = APPNRA12, TYPE = PU_T2.1 704
IST486I STATUS= ACTIV, DESIRED STATE= ACTIV
IST1043I CP NAME = APU, CP NETID = NETA, DYNAMIC LU = YES
IST1589I XNETALS = YES
IST1354I DLUR NAME = PO                                MAJNODE = SWAPPNRA
IST136I SWITCHED SNA MAJOR NODE = SWAPPNRA
IST654I I/O TRACE = OFF, BUFFER TRACE = OFF
IST1500I STATE TRACE = OFF
IST1656I VTAMTOPO = REPORT, NODE REPORTED - YES
IST1657I MAJOR NODE VTAMTOPO = REPORT
IST355I LOGICAL UNITS:
IST080I APULU1    ACTIV          APULU2    ACTIV          APULU3    ACTIV
IST080I APULU4    ACTIV
IST314I END
```

Customizing Configuration

- **snasw cpname**

- hung-pu-awareness: hung PU awareness timer interval (300 sec)
- hung-session-awareness: hung session awareness timer interval (180 sec)
- locate-timeout: locate search timeout interval (540 sec)
- max-pacing-window: ISR session max pacing window size
- remove-rscvs: strips rscvs on all downstream BINDs (downstream LEN/NN)
- station-segmentation: no interleaving of RUs for XID0 devices

- **snasw dlus**

NOTE: if you do not configure a DLUS, SNASwitch will use its current Network Node Server

- once: retry primary and backup just once each, then disconnect
- prefer-active: if a dlus is already active, use it exclusively
- retry: specify number of retries to each dlus and delay time between retries

- **snasw ip-precedence**

- TOS customization for EE traffic (low, med, high, network, Idlc)

Customizing Configuration (Cont.)

- **snasw link**

NOTE: you only configure links to upstream nodes. All other links come up dynamically with the following naming convention:

@D link names are for dynamic connection network links

@I link names are for normal downstream (implicit) links

@U link names are for DLUR connect out links

- ip-dest: specifies EE destination ip address (ipv4 ONLY)
- host-dest: specifies EE destination hostname (ipv4 or ipv6)
- rmac: specifies remote MAC addresses for non EE links
- rsap: specifies remote SAP
- nns: identifies a link to a preferred NNS
- tgp: low, med, high, or secure characteristics

Customizing Configuration (Cont.)

- **snasw location**

- Only applies to LEN nodes (i.e. snasw port is configured with conntype len)
- Not needed (registered automatically) if the Independent Logical Unit (ILU) name is LEN node's cpname, or if the ILU always initiates the session
- Causes the ILU to be registered with SNASw's Network Node Server so an upstream Primary LU can find the LEN ILU
- Registration only occurs when the LEN node connects in, allowing for redundant SNASw routers (TR, HSRP, DLSw downstream)
- Wildcards are allowed (in both names or only in owning-cp name) to save configuration steps when a naming convention is present
- Use xid if owning node does not have a CP name (new in recent 12.4)

```
(config)#snasw location MARTILU owning-cp NETA.MARTIN
```

```
(config)#snasw location NETA.LU* owning-cp NETA.CP*
```

```
(config)#snasw location NETA.LU xid 05e00001
```

Customizing Configuration (Cont.)

- **snasw port**

- conntype: non-EE only... nohpr, len, dyncplen, dialoutlen
- hostname: enable hostname (predefined or connection network, ipv4 or ipv6) for this port
- ldlc: tuning of LDLC liveness timer (LIVTIME), short request retry timer (SRQTIME), and short request retry interval (SRQRETRY)
- maxbtu: specify maximum btu size for segmentation (use 1496 for VDLC)
- max-links: limit number of links on this port
- nns-required: drop downstream links when CP-CP sessions to NNS lost to allow downstream PUs to connect to another SNASw router (used with vtok and vdlc ports only)
- no-limres: treat dynamic connection network links as non-limited resources
- qsize: number of packets allowed on IP/UDP inbound queue. Increase from default of 50 if “show ip socket detail” showing drops on ports 12000-12003 and highwater mark is 50, and also consider adjusting interface input hold queues and ip spd queue thresholds as well
- vnname: specify virtual routing node name (connection network)—**use separate loopback interface!**

Customizing Configuration (Cont.)

- **snasw rtp**
 - pathswitch-timers: set HPR pathswitch timers (HPRPST-low, med, high, network)

Conclusion: What Did We Learn?

- Concepts
 - SNASw is a DLUR, BrNN, and supports EE (the solution for replacing SNA routing in the data center)
- Design Considerations
 - SNASw in the branch is the best practice (full benefits of COS to TOS mapping and redundancy via IP network), but data center solution is commonly done
- Configuration Basics
 - SNASw configuration is relatively simple
- Troubleshooting Tools
 - SNASw has powerful tools for tracking down problems ... the pdlog, dlctrace, ipstrace, etc.

Information on APARs

II11220 – lists all z/OS informational APARs

This is an index to VTAM information APARs that contain lists of recommended maintenance. Each info APAR referred to is for a specific functional area of VTAM.

Releases:

HVT6140 = R140 = V1R4 = z/OS V1R4 R14

HVT6150 = R150 = V1R5 = z/OS V1R5 R15

HVT6160 = R160 = V1R6 = z/OS V1R6 R16

HVT6170 = R170 = V1R7 = z/OS V1R7 R17

HVT6180 = R180 = V1R8 = z/OS V1R8 R18

HVT6190 = R190 = V1R9 = z/OS V1R9 R19

[II13456](#) DLUR/DLUS for HVT6140, z/OS v1r4

[II13783](#) DLUR/DLUS for HVT6150 HVT6160 HVT6170 HVT6180

[II12223](#) Enterprise Extender (EE)

[II14056](#) HPR HVT6160, HVT6170

[II10953](#) HPR HVT510A, HVT6120, HVT6140, HVT6150

[II11952](#) OSA Express (QDIO)

Reference Materials

- SNASw — release guide, performance, troubleshooting, etc., also has links (on the left) to other Cisco IBM related technologies:

http://www.cisco.com/en/US/customer/tech/tk331/tk897/tsd_technology_support_sub-protocol_home.html

- Network management options:

http://www.cisco.com/en/US/partner/tech/tk331/tk336/technologies_white_paper0900aec80267747.shtml

- Redbook on FEP migration options:

<http://www.redbooks.ibm.com/abstracts/sg246298.html?Open>

- APPN Implementer's Workshop (architecture documents):

<http://www.networking.ibm.com/app/aiwdoc.htm>



End of Session

